

DEVICE DESCRIPTION

The TRAC family of Field Programmable Analog Devices offers an integrated path from signal processing problems to working silicon solutions - in minutes! The Totally Reconfigurable Analog Circuit is a highly flexible single chip solution to the signal processing problems found in many markets.

Introducing a Top-Down, Structured design discipline, TRAC enables rapid implementation, prototyping and product release. Rather than working at the component level, TRAC champions the Computational Approach, providing designers with benefits formerly associated only with programmable digital devices. TRAC brings a truly integrated Signal Processing problem solving process, offering a path to Custom Silicon for higher volume users.

TRAC devices have to be loaded with program data at power-up and run from a split 5V supply. By integrating the loading interface circuitry, voltage regulation, supply monitoring and thermal protection, the TRAC support circuit (TRAC-S2) further simplifies circuit integration and interface with memory devices.

An adjustable frequency oscillator clocks program data out of a serial output memory device and into any number of cascaded TRAC devices. By monitoring the bit stream pattern, TRAC-S2 can sense when loading is complete and stop clocking automatically.

An adjustable 'rail-splitter' generates the ground supply rail, and the supply monitoring function initiates program load on power-up, and after power failure or serious fluctuation. Thermal shutdown further protects the device against overheating.

FEATURES & BENEFITS

- Makes designing TRAC circuits easier, production prototyping quicker
- Reduces component count and manufacturing costs
- Enables simple connection of a serial output EEPROM or other memory device to TRAC
- Compatible with current and future TRAC devices
- Automatic program loading at power-up
- Supply monitor function reloads program after power failure or fluctuation
- Frequency of on-chip oscillator user-defined
- Senses number of cascaded TRAC devices automatically
- Automatically stops clocking when program loading complete
- Simplifies generation of TRAC supply voltages
- Ground voltage user defined
- Thermal shutdown function protects against overloading due to circuit failures
- Full industrial temperature range

ORDERING INFORMATION

PART NUMBER	PACKAGE	PART MARK
TRAC-S2Q16	QSOP16	TRAC-S2

TRAC-S2

ABSOLUTE MAXIMUM RATINGS

Supply Voltage	0V to +7V
Supply Current	50mA
Operating Temperature Range	-40°C to 85°C
Storage Temperature Range	-55°C to 125°C

ELECTRICAL CHARACTERISTICS

Test Conditions: Temperature=25°C, V_{DD}=5V, V_{SS}=0V, CLCR_IN=0V, 100nF between AGND_OUT and V_{SS}, unless otherwise stated.

PARAMETER	CONDITIONS	MIN	TYPICAL	MAX
Supply Voltage Operating Range		4.8V	5.0V	5.2V
Supply Current	Standby (CLCR_IN = 0V) Clocking (CLCR_IN = 5V)	1.5mA 2.9mA	1.9mA 3.7mA	2.8mA 5.5mA
RAIL SPLITTER				
SETV(Input Current)	SETV = 2.50V		50nA	200nA
AGND_OUT (Output Voltage)	SETV = 2.50V (No Load) SETV = 2.0V (No Load)	2.49V 1.99V	2.50V 2.00V	2.51V 2.01V
AGND_OUT (Output Voltage)	SETV = 2.50V; I _{SINK} = 20mA SETV = 2.50V; I _{SOURCE} = 20mA			AGND_OUT + 0.010V AGND_OUT - 0.010V
SUPPLY MONITOR				
RESET_OUT (Threshold Voltage)	High State Output (VDD increasing) Low State Output (VDD decreasing)	4.35V 4.35V	4.67V 4.65V	4.75V 4.75V
RESET_OUT (Hysteresis)		0.01V	0.02V	0.08V
RESET_OUT (Onstate output sink current)	VDD = RESET_OUT = 4V		0.14mA	
RESET_OUT (Offstate output current)	VDD = RESET_OUT = 5V		0.18mA	
PROPAGATION DELAY	VDD step from 5.0V to 4.0V		1μS	
PROGRAMMING LOGIC				
CLK_OUT (Frequency)	2.2nF between CAP and V _{SS} CLCR_IN = 5V	7kHz	10kHz	15kHz
CLK_OUT (Max Programming Frequency)	47pF between CAP and V _{SS} CLCR_IN = 5V			200kHz
CLK_OUT (High output voltage)	2.2nF between CAP and V _{SS} CLCR_IN = 5V	3.90V	4.10V	4.50V
NOT CLK_OUT(Frequency)	2.2nF between CAP and V _{SS} CLCR_IN = 5V	7kHz	10kHz	15kHz
NOT CLK_OUT(High output voltage)	2.2nF between CAP and V _{SS} CLCR_IN = 5V	4.00V	4.20V	4.60V

TRAC-S2

ELECTRICAL CHARACTERISTICS

Test Conditions: Temperature=25°C, V_{DD}=5V, V_{SS}=0V, CLCR_IN=0V, 100nF between AGND_OUT and V_{SS}, unless otherwise stated.

DATA_OUT(Frequency)	2.2nF between CAP and V _{SS} CLCR_IN = 5V	1.7kHz	2.5kHz	4.0kHz
DATA_OUT(High output voltage)	2.2nF between CAP and V _{SS} CLCR_IN = 5V	3.90V	4.10V	4.50V
SELECT (Output Voltage)	2.2nF between CAP and V _{SS} CLCR_IN = 5V	4.8V	4.99V	5.00V

DESCRIPTION OF PIN FUNCTIONS

Inputs

SETV	Defines the AGND_OUT voltage. Normally set by potential divider
CLCR_IN	Active high to enable clock
CAP	Capacitor to V _{SS} sets clock frequency

Outputs

AGND_OUT	Analog Ground. Able to source and sink current
SELECT	Active high when CLCR_IN is logic high. Enables memory device
CLK_OUT	Fed to EEPROM clock input
NOT CLK_OUT	Fed to TRAC clock input
DATA_OUT	CLK_OUT divided by four. Fed to serial output memory device
RESET_OUT	Reset for TRAC Support Circuit and TRAC devices

General notes for the TRAC Support Circuit

- An on-chip oscillator produces the output CLK_OUT and NOT CLK_OUT. CLCR_IN must be logic high (V_{DD}) to activate CLK_OUT and NOT CLK_OUT
- The CLK_OUT output frequency is divided by four to give the DATA_OUT output. Therefore CLCR_IN must be logic high (V_{DD}) to activate DATA_OUT
- For AGND_OUT stability under load, a 100nF capacitor is required between AGND_OUT and V_{SS}

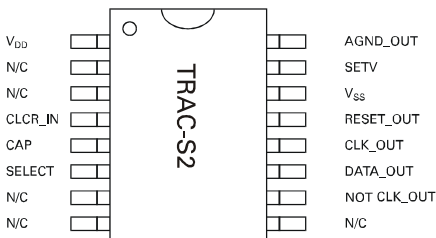

TRAC-S2

TYPICAL CHARACTERISTICS

Standby Current v Temperature

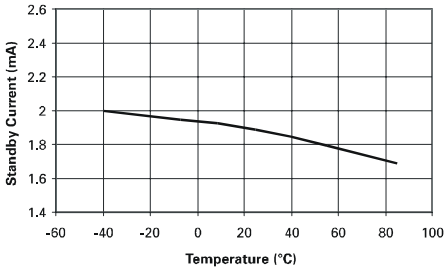

Clocking Current v Temperature

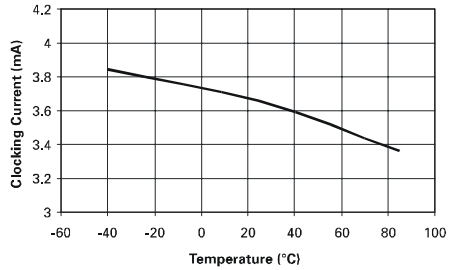

AGND-OUT v Load Current

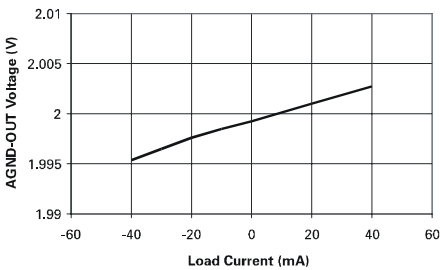

AGND-OUT v Temperature

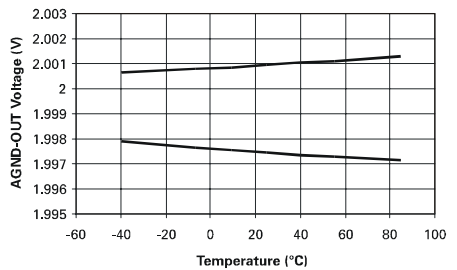

RESET-OUT Delay Time

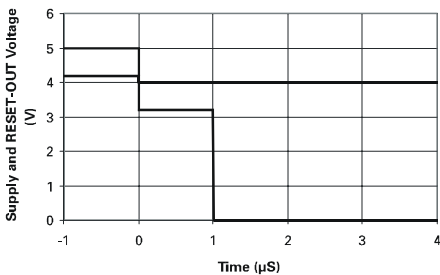

RESET-OUT Voltage v Supply Voltage

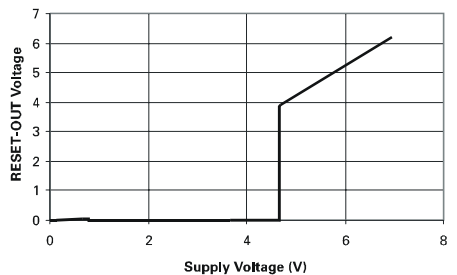

TRAC-S2

TYPICAL CHARACTERISTICS

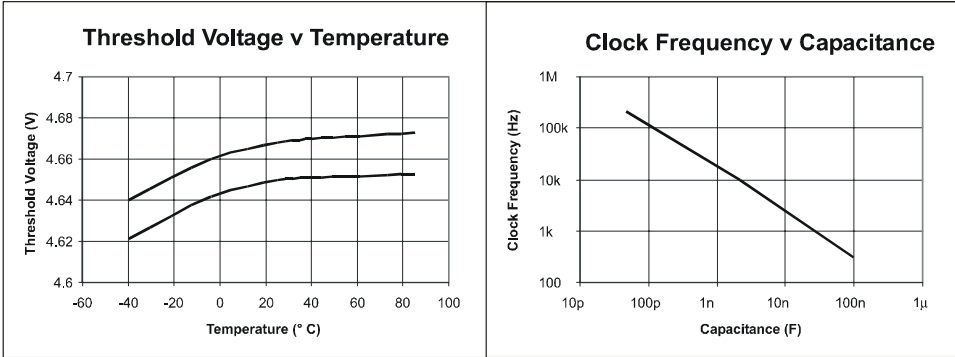

TRAC-S2

BLOCK DIAGRAM

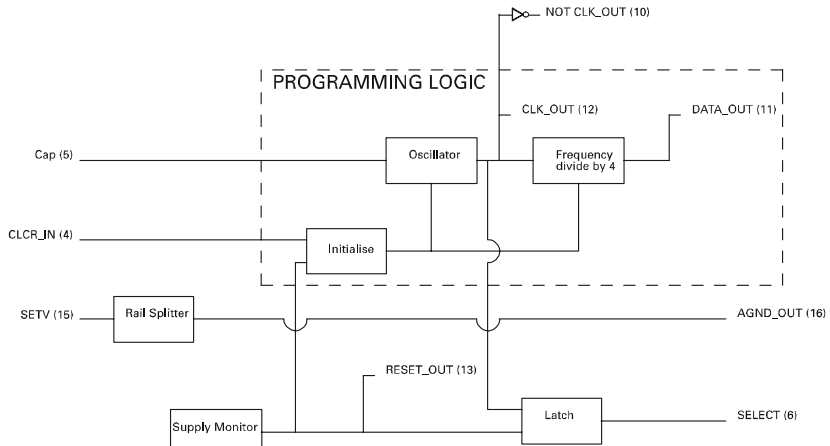

Description of the TRAC Support Circuit

1) Rail Splitter

This section provides the analog ground rail between the 5V supply. An external potential divider can be connected to the SETV pin which enables AGND_OUT to be set to the desired potential. The output stage of the rail splitter has been designed to provide power capabilities for 4 TRAC devices and accompanying circuitry. The circuit has low output resistance enabling a drive capability of +/- 20mA.

2) Supply Monitor

This section utilises the precision ZSM560 supply monitor design. The RESET_OUT provides a signal to reset all the devices included in the programming and operation of TRAC. This ensures that all devices are switched on and off simultaneously.

3) Programming Logic

This section provides TRAC and memory with the signals required for programming. The clock is generated on chip, with the frequency set by an external capacitor. The DATA_OUT signal is generated by dividing the clock frequency by 4. This provides the code to initialise an EEPROM and prompt it to output data. The SELECT pin enables EEPROM chip select.

This section also takes an input signal from the final TRAC device, CLCR_IN. This signal is normally 'high' and goes 'low' when programming is complete, and is used to terminate the CLK_OUT and DATA_OUT signals.

TRAC-S2

APPLICATION CIRCUIT

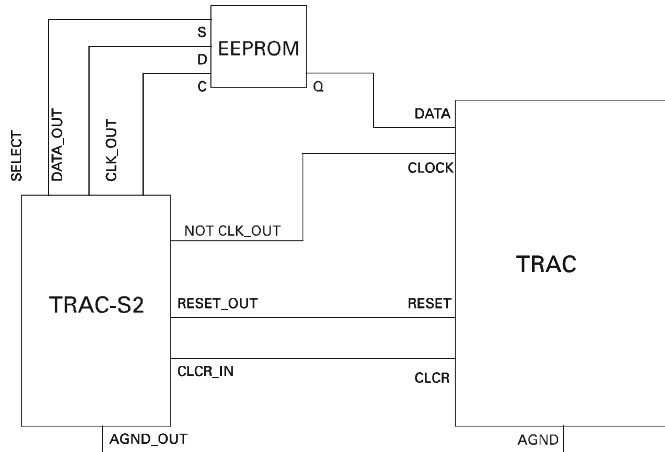

Connections between the support circuit, the EEPROM and the TRAC device are shown above.

For a more detailed explanation of the circuit see the application note AN27, "How to use the TRAC support chip". This also shows the circuit required to program multiple TRAC devices.

LIST OF COMPATIBLE MEMORY DEVICES

ST9346CB1 (SGS-Thomson)

93LC46B (Microchip)

NM92C46 (National Semiconductor)

TRAC-S2

PACKAGE DIMENSIONS

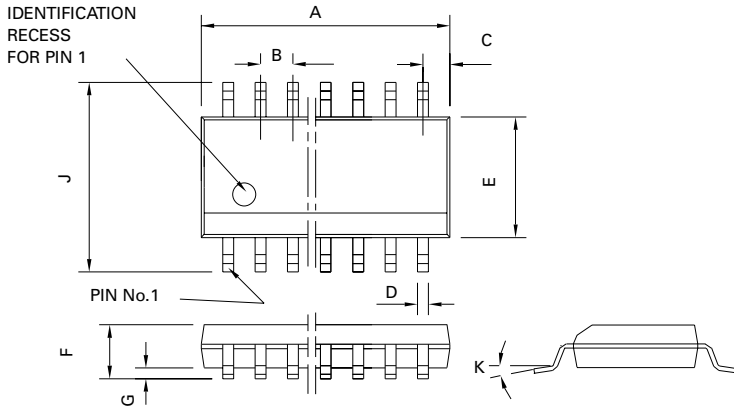

QSOP16

PIN	Millimetres		Inches	
	MIN	MAX	MIN	MAX
A	4.80	4.98	0.189	0.196
B	0.635		0.025 NOM	
C	0.177	0.267	0.007	0.011
D	0.20	0.30	0.008	0.012
E	3.81	3.99	0.15	0.157
F	1.35	1.75	0.053	0.069
G	0.10	0.25	0.004	0.01
J	5.79	6.20	0.228	0.244
K	0°	8°	0°	8°



ZETEX

Zetex plc.

Fields New Road, Chadderton, Oldham, OL9-8NP, United Kingdom.

Telephone: (44)161 622 4422 (Sales), (44)161 622 4444 (General Enquiries)

Fax: (44)161 622 4420

Zetex GmbH
Streitfeldstraße 19
D-81673 München
Germany
Telefon: (49) 89 45 49 49 0
Fax: (49) 89 45 49 49 49

Zetex Inc.
47 Mall Drive, Unit 4
Commack NY 11725
USA
Telephone: (631) 543-7100
Fax: (631) 864-7630

Zetex (Asia) Ltd.
3510 Metroplaza, Tower 2
Hing Fong Road,
Kwai Fong, Hong Kong
Telephone: (852) 26100 611
Fax: (852) 24250 494

These are supported by
agents and distributors in
major countries world-wide
©Zetex plc 2000

Internet: <http://www.zetex.com>

This publication is issued to provide outline information only which (unless agreed by the Company in writing) may not be used, applied or reproduced for any purpose or form part of any order or contract or be regarded as a representation relating to the products or services concerned. The Company reserves the right to alter without notice the specification, design, price or conditions of supply of any product or service.

This datasheet has been download from:

www.datasheetcatalog.com

Datasheets for electronics components.