

REED click

2. Soldering the headers

Before using your click board™, make sure to solder 1x8 male headers to both left and right side of the board. Two 1x8 male headers are included with the board in the package.

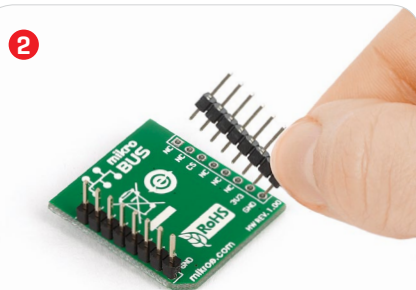
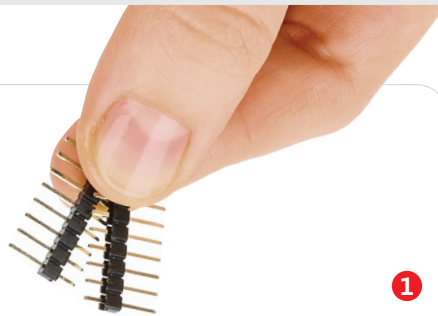

Turn the board upside down so that the bottom side is facing you upwards. Place shorter pins of the header into the appropriate soldering pads.

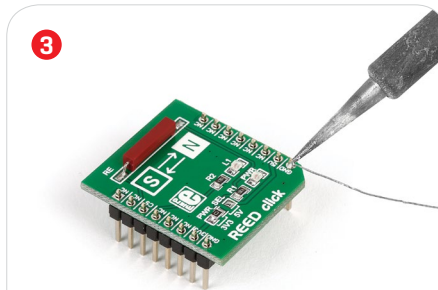

Turn the board upward again. Make sure to align the headers so that they are perpendicular to the board, then solder the pins carefully.

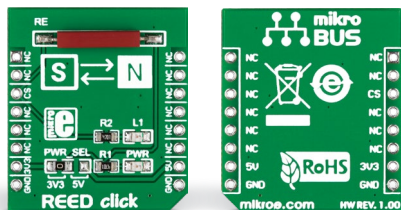

1. Introduction

REED click is a simple board that carries a standard **[Single Pole Single Throw Normally Open]** reed switch — a simple hermetically sealed switch that can be activated with a magnet or electromagnetic coil [in other words a magnet-activated low-current relay]. A single mikroBUS™ pin [CS] connected to the MCU is outputting a 1 or 0 depending on the whether the switch is close or open. REED click is designed to use either a 3.3V or a 5V power supply.

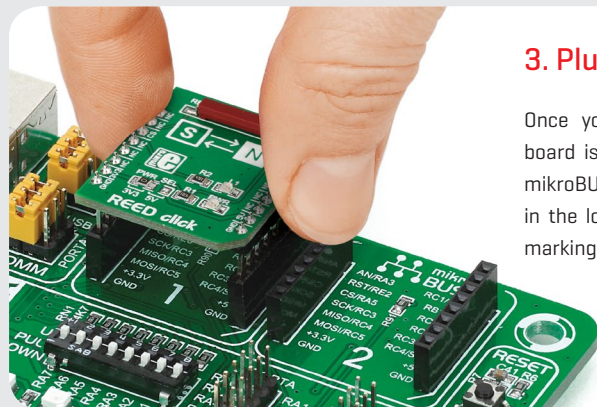

3. Plugging the board in

Once you have soldered the headers your board is ready to be placed into the desired mikroBUS™ socket. Make sure to align the cut in the lower-right part of the board with the markings on the silkscreen at the mikroBUS™ socket. If all the pins are aligned correctly, push the board all the way into the socket.

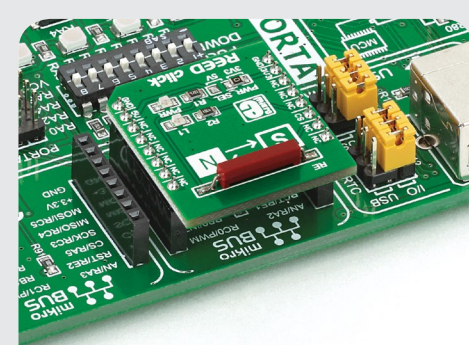

4. Essential features

A reed switch comprises two thin magnetic contacts sealed inside a glass casing. One contact is a magnetic north pole, the other a south. The two contacts are separate, until a magnetic field is applied which snaps them shut, activating the switch. Once the magnet is removed, they open up again. Reed switches are widely used in a variety of applications: door sensors, liquid level sensors [by employing magnetic floats], but also protective casings for phones, tablets, ebook readers etc.



REED click Manual v100



0100000090909

5. Schematic

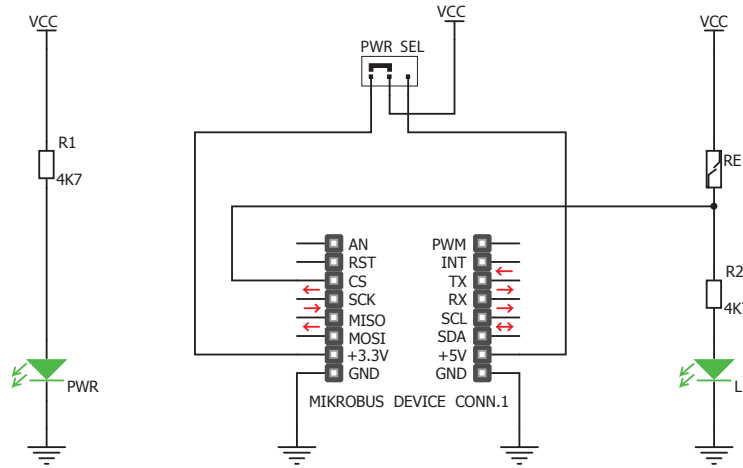

6. Dimensions

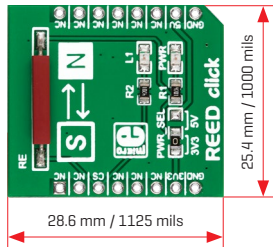

	mm	mils
LENGTH	28.6	1125
WIDTH	25.4	1000
HEIGHT*	3.3	130

* without headers

7. SMD jumper

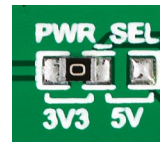

Reed click features an SMD jumper [zero ohm resistor] that let's you switch between a 3.3V or a 5V power supply.

8. Code examples

Once you have done all the necessary preparations, it's time to get your click board™ up and running. We have provided examples for mikroC™, mikroBasic™ and mikroPascal™ compilers on our **Libstock** website. Just download them and you are ready to start.



9. Support

MikroElektronika offers **free tech support** [www.mikroe.com/support] until the end of the product's lifetime, so if something goes wrong, we're ready and willing to help!



10. Disclaimer

MikroElektronika assumes no responsibility or liability for any errors or inaccuracies that may appear in the present document. Specification and information contained in the present schematic are subject to change at any time without notice.

Copyright © 2015 MikroElektronika.
All rights reserved.