

## 4-20mA R click™

### 1. Introduction

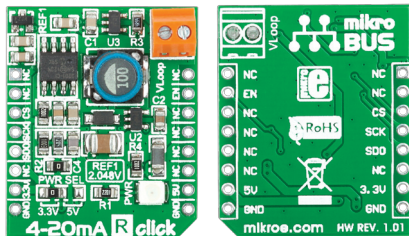

4-20mA R Click™ is an accessory board in **mikroBUS™** form factor. It's a compact and easy solution for adding 4-to-20mA industry standard communication protocol to your design. It features **INA196** current shunt monitor, **MCP3201** 12-bit ADC as well as **TPS61041** DC/DC boost converter. 4-20mA R Click™ communicates with target board microcontroller via **mikroBUS™** SPI (SDO, SCK, CS) and EN lines. The board is designed to use 3.3V and 5V power supply. LED diode indicates the presence of power supply.

### 2. Soldering the headers

Before using your click board™, make sure to solder 1x8 male headers to both left and right side of the board. Two 1x8 male headers are included with the board in the package.

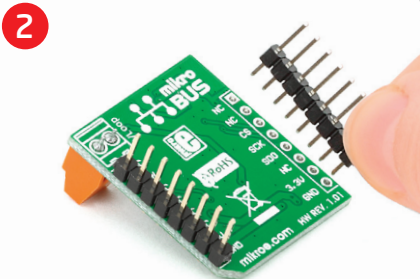
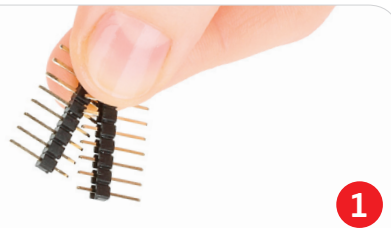

Turn the board upside down so that bottom side is facing you upwards. Place shorter parts of the header pins in both soldering pad locations.

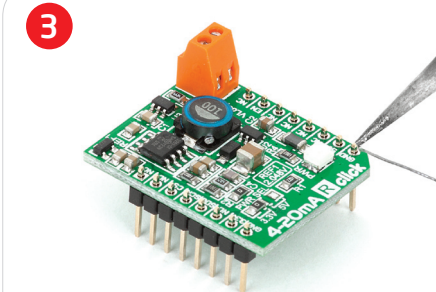

Turn the board upward again. Make sure to align the headers so that they are perpendicular to the board, then solder the pins carefully.



### 3. Plugging the board in

Once you have soldered the headers your board is ready to be placed into desired mikroBUS™ socket. Make sure to align the cut in the lower-right part of the board with the markings on the silkscreen at the mikroBUS™ socket. If all of the pins are aligned correctly, push the board all the way into the socket.

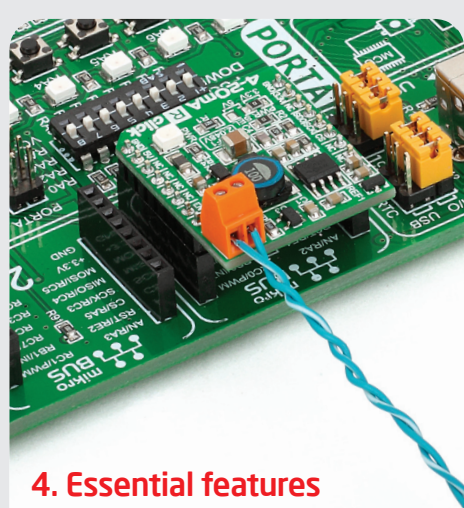

### 4. Essential features

4-20mA R Click™ board is ideal for using in field of industrial process control and test systems. The board serves as receiver in 4-20mA current loop standard. It receives output current (4-20mA) from transmitter and convert into a voltage (0.4-2V). Then through the AD converter sends signal to main board microcontroller. This board and the 4-20mA T Click™ board together form a complete 4-to-20mA current loop standard.

click™  
BOARD  
[www.mikroe.com](http://www.mikroe.com)



4-20mA R click Manual  
ver. 1.01



0 100000 023242

## 5. 4-20mA R Click™ Board Schematic

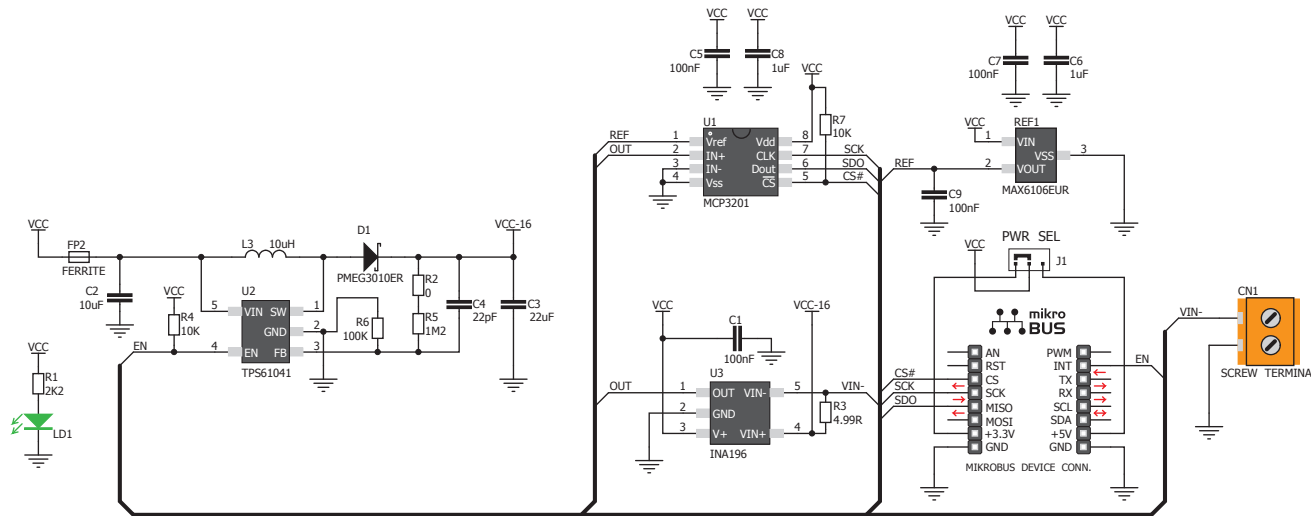

MikroElektronika assumes no responsibility or liability for any errors or inaccuracies that may appear in the present document. Specification and information contained in the present schematic are subject to change at any time without notice. Copyright © 2013 MikroElektronika. All rights reserved.

## 6. SMD Jumper

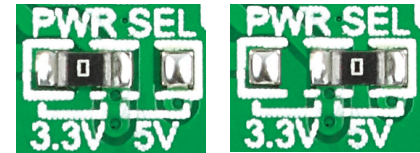

There is one zero-ohm SMD jumper **J1** used to select whether 3.3V or 5V power supply is used. Jumper **J1** is soldered in 3.3V position by default.

## 7. Code Examples

Once you have done all the necessary preparations, it's time to get your click board up and running. We have provided the examples for mikroC, mikroBasic and mikroPascal compilers on our **Libstock** website. Just download them and you are ready to start.



## 8. Support

MikroElektronika offers **Free Tech Support** ([www.mikroe.com/esupport](http://www.mikroe.com/esupport)) until the end of product lifetime, so if something goes wrong, we are ready and willing to help!