

LTM4636
High Efficiency, PolyPhase 80A
Step-Down Power μ Module Regulator

DESCRIPTION

Demonstration circuit DC2448A-A features a PolyPhase® design using the LTM®4636EY, a 40A high efficiency, switch mode step-down power μ Module® regulator. The input voltage range is from 4.7V to 15V. When $V_{IN} < 5.5V$, short PVCC to VIN with R1 = 0 Ω , and set R3 = 0 Ω and remove R2. The output voltage range is 0.6V to 3.3V. The DC2448A-A can deliver a nominal 80A output current. As explained in the data sheet, output current derating is necessary for certain V_{IN} , V_{OUT} , and thermal conditions. The board operates in continuous conduction mode in heavy load conditions. For high efficiency at low load currents, the MODE_PLLIN jumper selects pulse-skipping mode for

noise sensitive applications or Burst Mode® operation in less noise sensitive applications. The MODE_PLLIN pin also allows the LTM4636 to synchronize to an external clock signal. The phase shift between the two phases is 180 degree. DC2448A-A has the option of choosing both internal and external compensation circuit for LTM4636. The LTM4636 data sheet must be read in conjunction with this demo manual prior to working on or modifying demo circuit DC2448A-A.

Design files for this circuit board are available at <http://www.analog.com/DC2448A-A>

All registered trademarks and trademarks are the property of their respective owners.

BOARD PHOTO

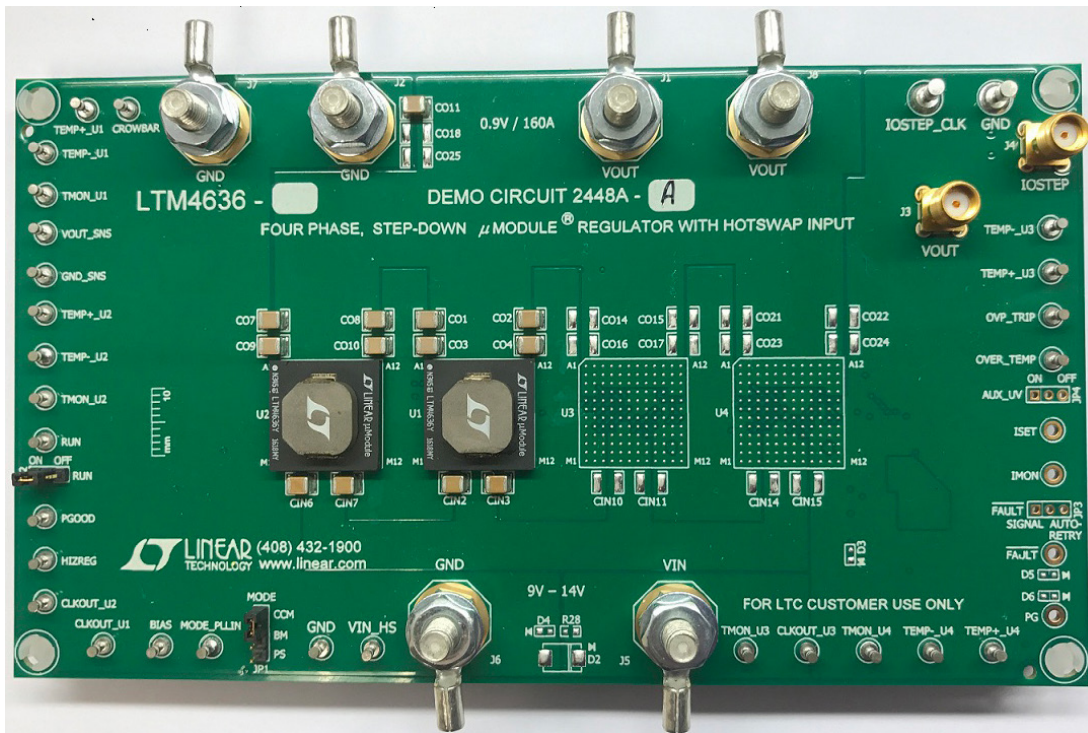

DEMO MANUAL

DC2448A-A

PERFORMANCE SUMMARY Specifications are at $T_A = 25^\circ\text{C}$

PARAMETER	CONDITIONS	VALUE
Input Voltage Range		4.7V to 15V
Output Voltages		$0.9\text{V} \pm 1.3\%$
Maximum Continuous Output Current	Derating is necessary for certain operating conditions. See data sheet for details.	80A_{DC}
Operating Frequency		350kHz
Efficiency	$V_{\text{IN}} = 12\text{V}$, $V_{\text{OUT}} = 0.9\text{V}$, $I_{\text{OUT}} = 80\text{A}$	87.0% Figure 2
Load Transient $V_{\text{OUT(P-P)}}$	$V_{\text{IN}} = 12\text{V}$, $V_{\text{OUT}} = 0.9\text{V}$, $I_{\text{STEP}} = 0\text{A TO } 20\text{A}$	109mV Figure 3

QUICK START PROCEDURE

Demonstration circuit DC2448A-A is an easy way to evaluate the performance of PolyPhase operation of the LTM4636EY. Due to the high input/output current, the user should select the proper input supply/load/cable which can sustain the full load operation. Please refer to Figure 1 for proper measurement equipment setup and follow the procedure below:

1. Place jumpers in the following positions for a typical application:

MODE	RUN
CCM	ON

2. With power off, connect the input power supply, load and meters as shown in Figure 1. Preset the load to 0A and V_{IN} supply to 12V.
3. Turn on the power supply at the input. The output voltage should be $0.9\text{V} \pm 1.3\%$ (0.888V to 0.912V).

4. Vary the input voltage from 6V to 15V and adjust the load current from 0A to 80A. Observe the output voltage regulation, ripple voltage, efficiency and other parameters.
5. (Optional) For optional load transient test, apply an adjustable pulse signal between IOSTEP_CLK and GND test points. The pulse amplitude sets the load step current amplitude. Keep the pulse width short (<1ms) and pulse duty cycle low (<5%) to limit the thermal stress on the load transient circuit.
6. (Optional) LTM4636 can be synchronized to an external clock signal. Apply a clock signal (0V to 5V, square wave) on the MODE_PLLIN test point.
7. (Optional) The outputs of LTM4636 can track another supply. The output voltage tracks the voltage on TRACK when a valid signal is applied on the test point.

QUICK START PROCEDURE

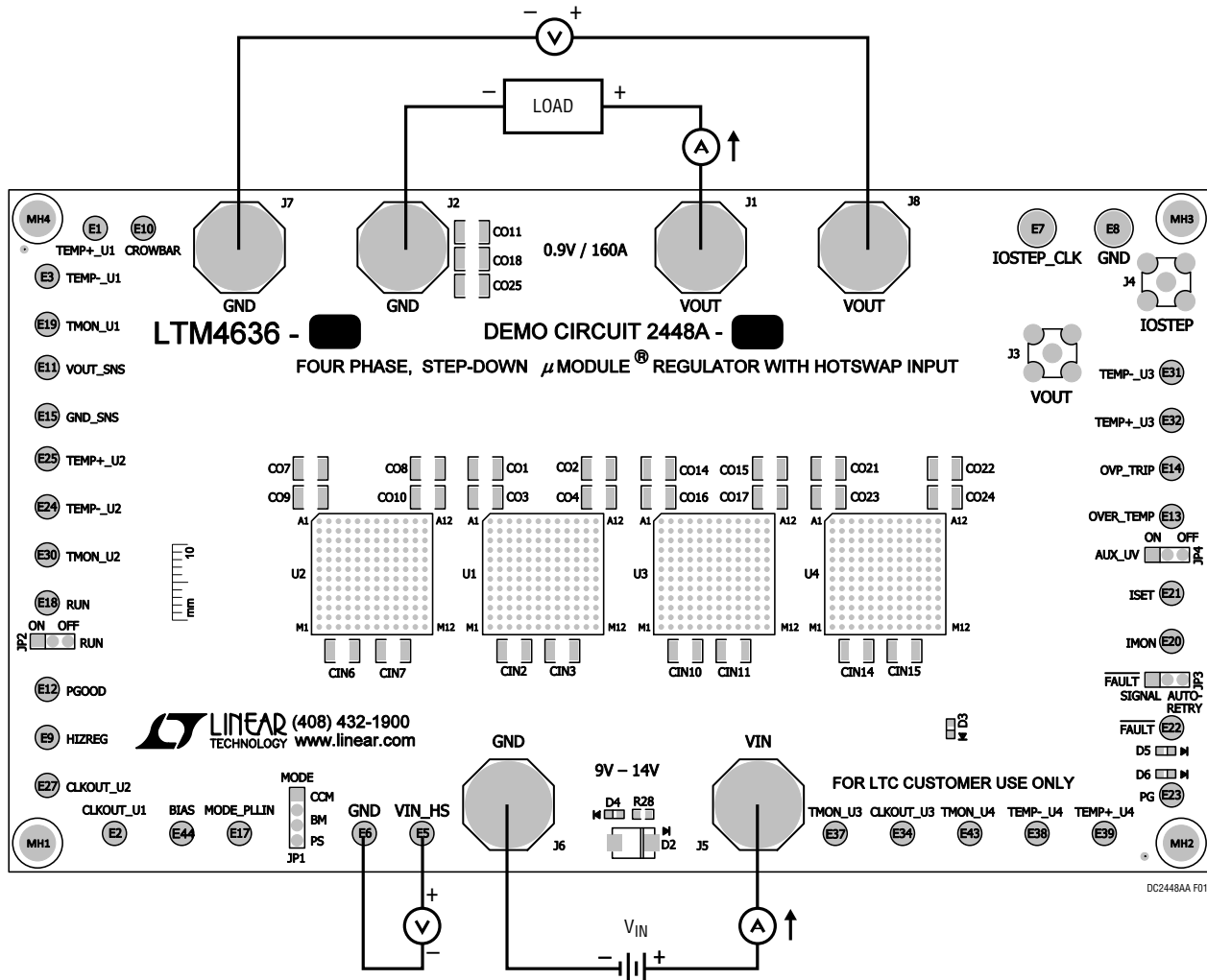

Figure 1. Measurement Setup of DC2448A-A

QUICK START PROCEDURE

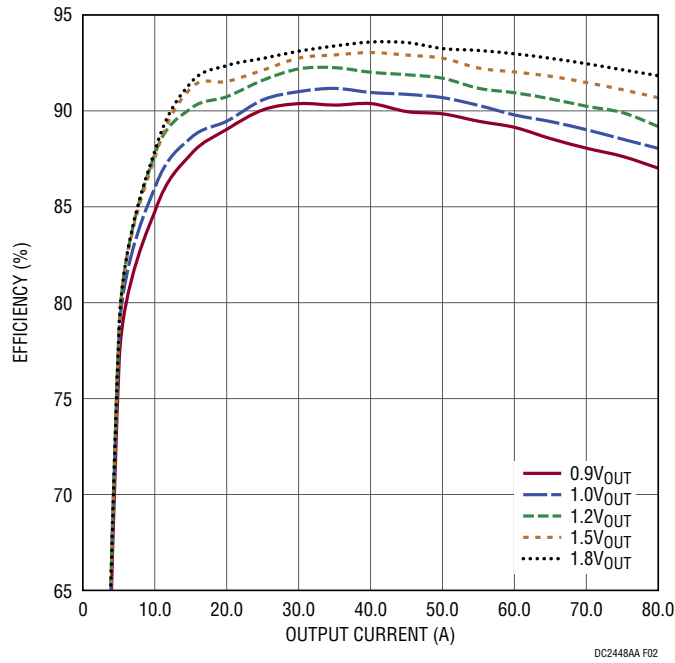

Figure 2. Measured Efficiency at $V_{IN} = 12V$, $f_{SW} = 350kHz$, CCM

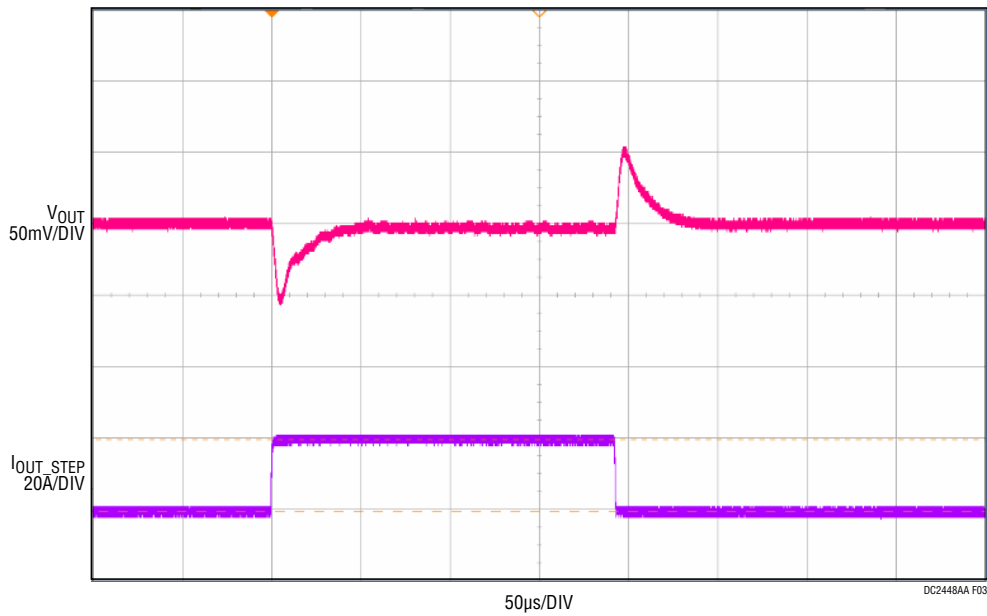

Figure 3. Measured Load Transient
 $V_{IN} = 12V$, $V_{OUT} = 0.9V$, $I_{STEP} = 0A$ to $20A$

QUICK START PROCEDURE

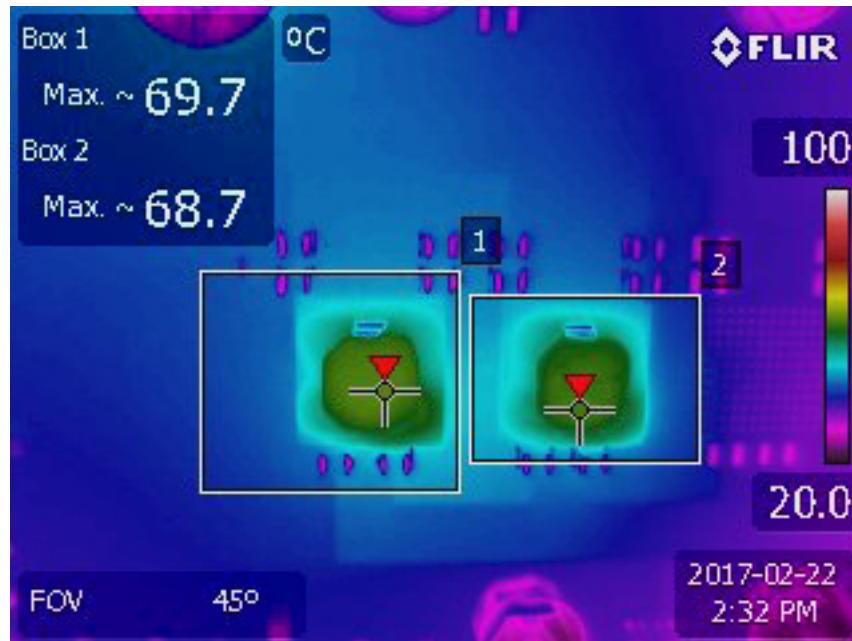

Figure 4. Thermal Capture at $V_{IN} = 12V$, $V_{OUT} = 0.9V$, 80A ($T_A = 25^\circ C$, 200LFM Airflow and No Heat Sink)

DEMO MANUAL

DC2448A-A

PARTS LIST

ITEM	QTY	REFERENCE	PART DESCRIPTION	MANUFACTURER/PART NUMBER
Required Circuit Components				
1	2	C1, C14	CAP, 22 μ F, X7R, 10V, 10%, 1206	MURATA, GRM31CR71A226KE15L
2	2	C2, C15	CAP, 4.7 μ F, X5R, 25V, 20%, 0805	MURATA, GRM21BR61E475MA12L
3	1	C8	CAP, 100pF, X7R, 50V, 10%, 0603	AVX, 06035C101KAT2A
4	2	C9, C10	CAP, 0.47 μ F, X7R, 10V, 10%, 0603	AVX, 0603ZC474KAT2A MURATA, GRM188R71A474KA61D
5	2	C29, C30	CAP, 10 μ F, X5R, 6.3V, 10%, 0805	MURATA, GRM21BR60J106KE19L
6	11	C31, C32, C01, C02, C03, C04, C07, C08, C09, C010, C011	CAP, 100 μ F, X5R, 6.3V, 20%, 1210	MURATA, GRM32ER60J107ME20L
7	1	CIN1	CAP, 150 μ F, ALUM., 35V, 20%, 10x10.5mm, SMD, HVH Series	SUN ELECTRONIC INDUSTRIES CORP, 35HVH150M
8	8	CIN2, CIN3, CIN4, CIN5, CIN6, CIN7, CIN8, CIN9	CAP, 22 μ F, X5R, 25V, 10%, 1210	AVX, 12103D226KAT2A MURATA, GRM32ER61E226KE15L
9	4	C05, C06, C012, C013	CAP, 470 μ F, TANT. POLY., 4V, 20%, 7343, D3L	PANASONIC, 4TPE470MCL
10	1	R14	RES., 10k, 1%, 1/10W, 0603	KOA SPEER, RK73H1JTTD1002F PANASONIC, ERJ3EKF1002V VISHAY, CRCW060310K0FKEA
11	1	R20	RES., 4.99k, 1%, 1/10W, 0603	NIC, NRC06F4991TRF VISHAY, CRCW06034K99FKEA
12	2	R22, R51	RES., 34.8k, 1%, 1/10W, 0603	VISHAY, CRCW060334K8FKEA YAGEO, RC0603FR-0734K8L
13	2	U1, U2	IC, HIGH EFFICIENCY 40A μ MODULE	LINEAR TECHNOLOGY, LTM4636EY#PBF
Additional Demo Board Circuit Components				
1	2	C6, C17	CAP, 2200pF, X7R, 50V, 10%, 0603	AVX, 06035C222KAT2A
2	1	C33	CAP, 1 μ F, X7R, 16V, 10%, 0603	AVX, 0603YC105KAT2A NIC, NMC0603X7R105K16TRPF TDK, C1608X7R1C105K080AC
3	1	Q3	XSTR., MOSFET, N-CH, 40V, TO-252	VISHAY, SUD50N04-8M8P-4GE3
4	5	R2, R16, R19, R45, R50	RES., 0 Ω , 1/10W, 0603	NIC, NRC06Z0TRF VISHAY, CRCW06030000Z0EA
5	4	R4, R5, R12, R15	RES., 10k, 5%, 1/10W, 0603, AEC-Q200	PANASONIC, ERJ3GEYJ103V VISHAY, CRCW060310K0JNEA
6	1	R7	RES., 0.01 Ω , 1%, 1W, 2010, HIGH POWER	VISHAY, WSL2010R0100FEA18
7	2	R8, R9	RES., 51 Ω , 5%, 1/10W, 0603	VISHAY, CRCW060351R0JNEA
8	2	R18, R49	RES., 2.2 Ω , 5%, 1/8W, 0805, AEC-Q200	VISHAY, CRCW08052R20JNEA
9	4	R24, R26, R32, R37	RES., 0 Ω , 3/4W, 2010, AEC-Q200	VISHAY, CRCW20100000Z0EF
10	1	R25	RES., 0 Ω , 1W, 2512, SENSE	VISHAY, WSL251200000ZEA9
11	1	R76	RES., 0 Ω , 1W, 2010, SENSE, AEC-Q200	VISHAY, WSL201000000ZEA9

PARTS LIST

ITEM	QTY	REFERENCE	PART DESCRIPTION	MANUFACTURER/PART NUMBER
Hardware: For Demo Board Only				
1	27	E1, E2, E3, E5, E6, E9, E10, E11, E12, E13, E14, E15, E17, E18, E19, E24, E25, E27, E30, E31, E32, E34, E37, E38, E39, E43, E44	TEST POINT, TURRET, 0.064", MTG. HOLE	MILL-MAX, 2308-2-00-80-00-00-07-0
2	2	E7, E8	TEST POINT, TURRET, 0.094", MTG. HOLE	MILL-MAX, 2501-2-00-80-00-00-07-0
3	6	J1, J2, J5, J6, J7, J8	WASHER, FLAT, STEEL, ZINC PLATE, OD: 0.436 [11.1]	KEYSTONE, 4703
4	6	J1, J2, J5, J6, J7, J8	RING, LUG, CRIMP, #10, NON-INSULATED, SOLDERLESS TERMINALS	KEYSTONE, 8205
5	6	J1, J2, J5, J6, J7, J8	STUD, FASTENER, #10-32	PENNINGENGINEERING, KFH-032-10ET
6	6	J1, J2, J5, J6, J7, J8	NUT, HEX, STEEL, ZINC PLATE, 10-32	KEYSTONE, 4705
7	2	J3, J4	CONN., SMA RF COAX, PCB JACK RCPT, THT, STR	MOLEX, 73391-0060
8	1	JP1	CONN., HDR., MALE, 1x4, 2mm, THT, STR	SAMTEC, TMM-104-02-L-S
9	1	JP2	CONN., HDR., MALE, 1x3, 2mm, THT, STR	SAMTEC, TMM-103-02-L-S
10	4	MH1, MH2, MH3, MH4	STANDOFF, NYLON, SNAP-ON, 0.250"	KEYSTONE, 8831 WURTH ELEKTRONIK, 702931000
11	2	XJP1, XJP2	CONN., SHUNT, FEMALE, 2 POS, 2mm	SAMTEC, 2SN-BK-G

DEMO MANUAL DC2448A-A

SCHEMATIC DIAGRAM

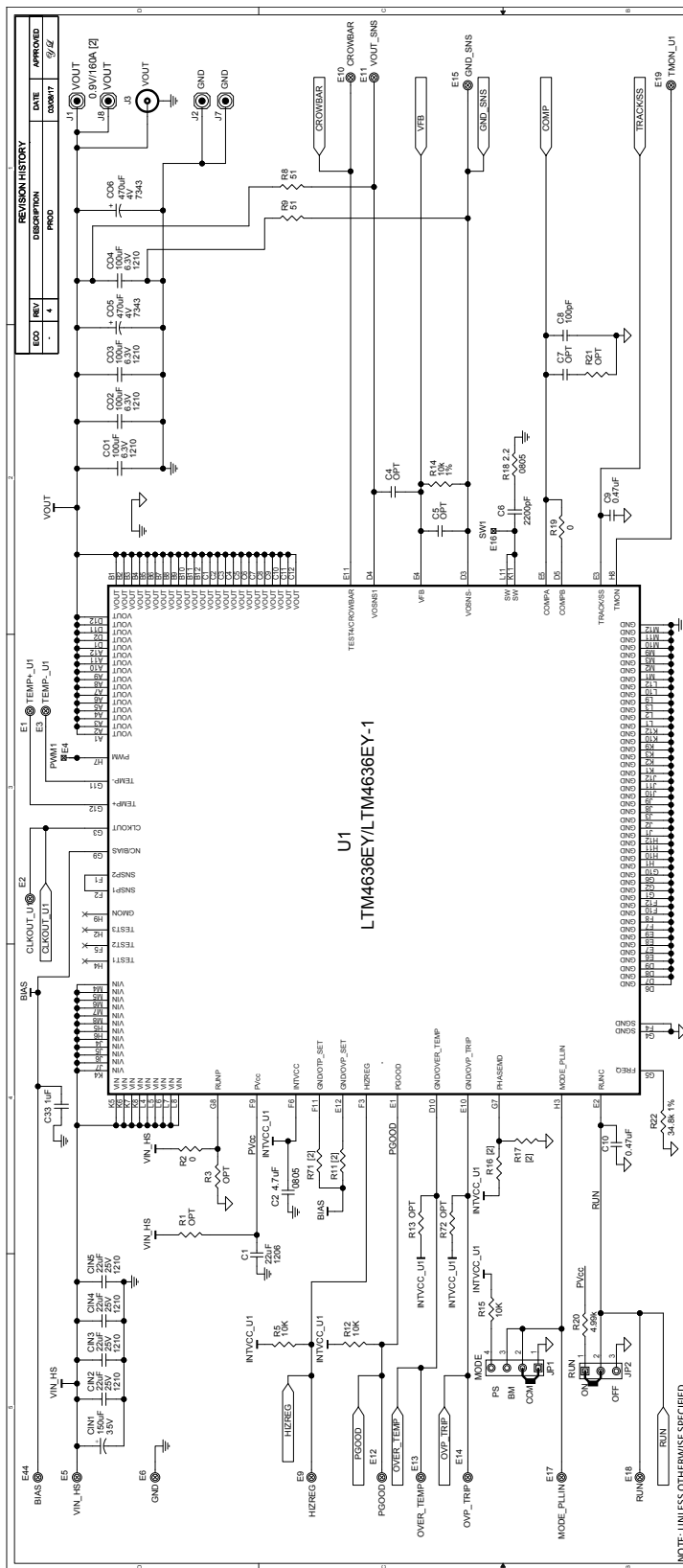

U1
LTM4636EY/LTM4636EY-1

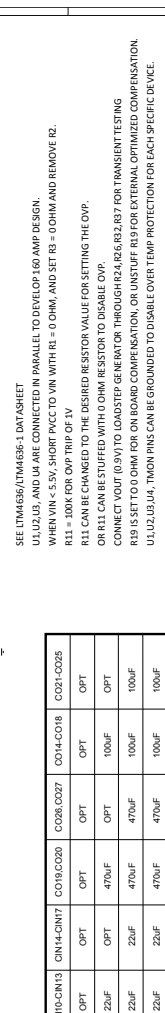

SEE LTM4636/LTM4636-1 DATA SHEET

U1, U2, U3, AND U4 ARE CONNECTED IN PARALLEL TO DEVELOP 160 AMP DESIGN.

WHEN VIN < 5.5V, SHORT P1C2 TO VIN WITH R1 = 0 OHM, AND SET R3 = 0 OHM AND REMOVE R2.

R11 = 100K FOR OVP TRIP OF 1V.

R8, R11 CAN BE CHANGED TO THE DESIRED RESISTOR VALUE FOR SETTING THE OVP.

R9, R11 CAN BE STUFFED WITH 0 OHM RESISTOR TO DISABLE OVP.

CONNECT VOLT (0.9V) TO LOADSTEP GENERATOR THROUGH R34, R35, R32, R37 FOR TRANSIENT TESTING.

R19 IS SET TO 0 OHM FOR ON REGAIN COMPENSATION, OR UNSTUFF R19 FOR EXTERNAL OPTIMIZED COMPENSATION.

U1, U2, U3, U4, TRIM1 THIS CAN BE GROUNDING TO DISABLE OVER TEMP PROTECTION FOR EACH SPECIFIC DEVICE.

IC	IOUT	R17	R47	R56	R66	R74, R75, R44, R75	R11	R25	R76	CO19, CO20	CO26, CO27	CO14, CO18	CO21, CO25
A	10A	0	OPT	OPT	OPT	OPT	OPT	0	0	OPT	OPT	OPT	OPT
B	120A	0	OPT	OPT	OPT	OPT	OPT	0	0	470nF	OPT	OPT	OPT
C	160A	0	0	0	0	0	OPT	0	0	22nF	470nF	100nF	100nF
D	160A	0	0	0	0	0	100nF	0.001 1%	0	470nF	470nF	100nF	100nF

NOTE: UNLESS OTHERWISE SPECIFIED, 1. ALL CAPACITORS, RESISTORS 0603. 2. ASSEMBLY OPTIONS.

REVISION HISTORY

ECO	REV	DESCRIPTION	DATE	APPROVED
	4			

CUSTOMER NOTICE

LINEAR TECHNOLOGY HAS MADE A BEST EFFORT TO DESIGN A PRODUCT THAT MEETS THE USER'S REQUIREMENTS. THE USER MUST EVALUATE THE PRODUCT FOR THE USER'S APPLICATION. COMPONENT SUBSTITUTION AND PRINTING CHANGES ARE AT THE USER'S RISK. CONTRACT LINEAR TECHNOLOGY FOR TECHNICAL SPECIFICATIONS AND SERVICE.

APPROVALS

DESIGNER	DATE

APPROVALS

DESIGNER	DATE

TITLE: SCHEMATIC

FOUR PHASE, STEP-DOWN, MODULE REGULATOR WITH HOT SWAP INPUT

SIZE: N/A

REV: 4

DATE: Feb 10, 2017

SCALE: NONE

SHEET 1 OF 5

1629 MACAWAY BLVD
MILLIS, MA 01928
PHONE: (617) 329-1900
WWW.LINEAR.COM

LINEAR TECHNOLOGY
1629 MACAWAY BLVD
MILLIS, MA 01928
TEL: 617-329-1900
WWW.LINEAR.COM

SCHEMATIC DIAGRAM

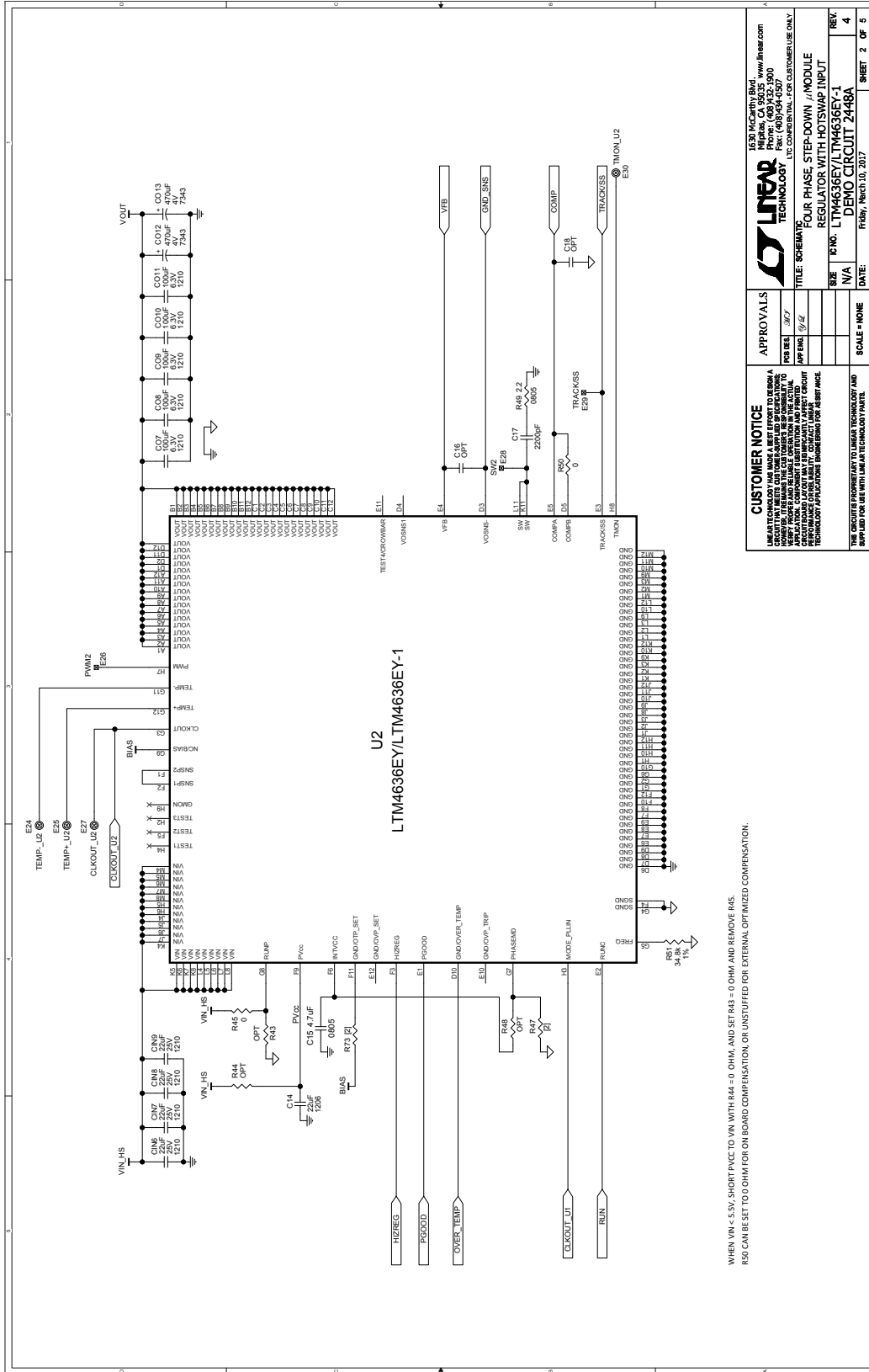

WHEN VIN = 5.5V, SHORT PVCC TO VIN WITH R44 = 0 OHM, AND SET R43 = 0 OHM AND REMOVE R45.
 R50 CAN BE SET TO 0 OHM FOR ON BOARD COMPENSATION, OR UNSTUFFED FOR EXTERNAL OPTIMIZED COMPENSATION.

DEMO MANUAL DC2448A-A

SCHEMATIC DIAGRAM

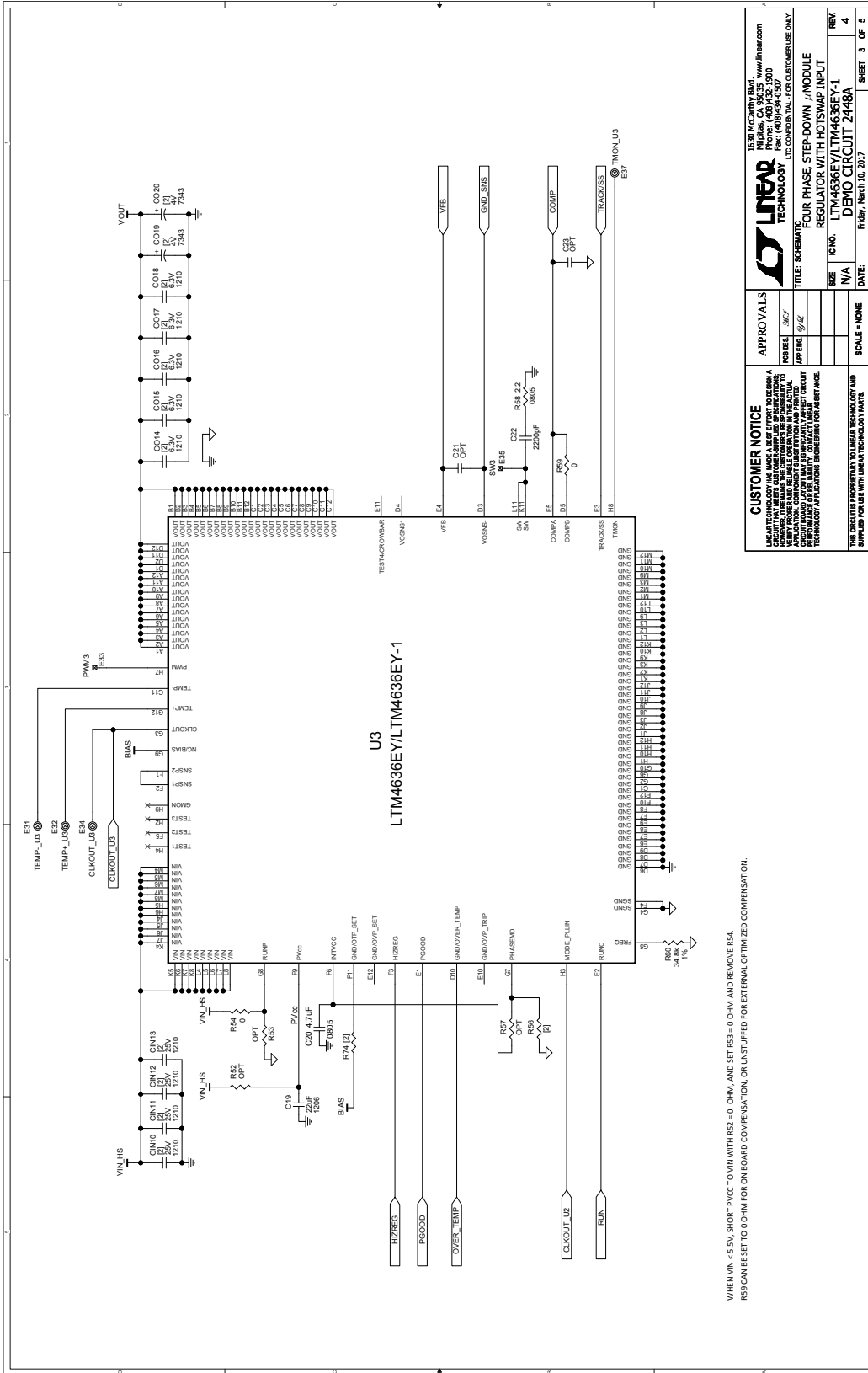

CUSTOMER NOTICE LINEAR TECHNOLOGY HAS MADE A BEST EFFORT TO DESIGN A DEMO BOARD THAT MEETS THE USER'S REQUIREMENTS. THE USER ASSUMES ALL LIABILITY FOR THE BOARD'S PERFORMANCE IN HIS APPLICATION. COMMENTS, REQUESTS FOR INFORMATION AND PRINTED CIRCUIT BOARD FILES ARE WELCOME. CONTACT LINEAR TECHNOLOGY FOR TECHNICAL SUPPORT OR FOR SERVICE.	APPROVALS PCB DES: [Signature] APP ENG: [Signature]	LINEAR TECHNOLOGY 1629 Massachusetts Road Milpitas, CA 95035 www.linear.com Phone: (408) 352-1900 FAX: (408) 352-1901 E-MAIL: CUSTOMER_SUPPORT@LINEAR.COM
	TITLE: SCHEMATIC REGULATOR WITH HOTSWAP INPUT	SIZE: N/A DATE: 10/2017

SCHEMATIC DIAGRAM

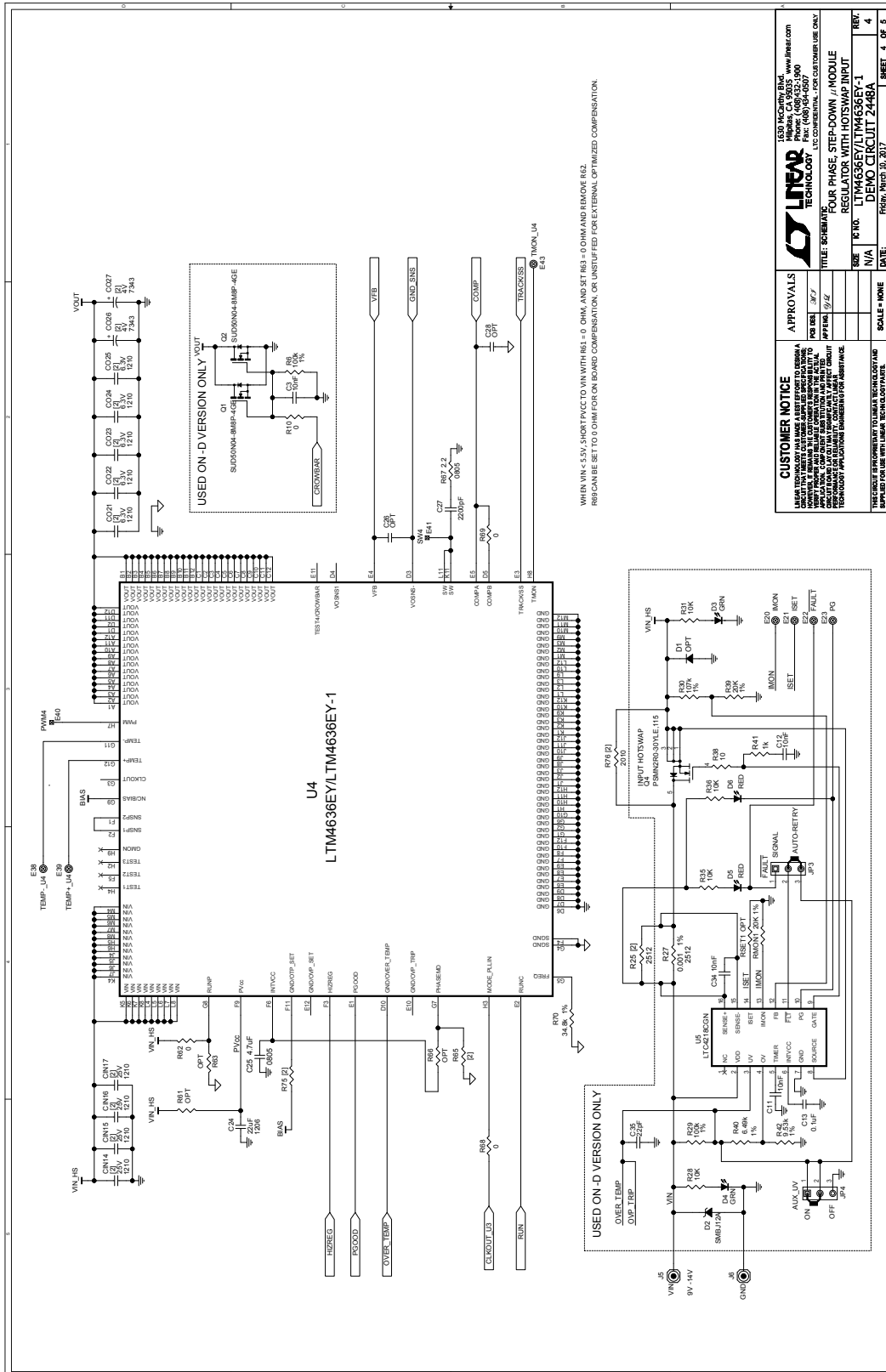



ESD Caution

ESD (electrostatic discharge) sensitive device. Charged devices and circuit boards can discharge without detection. Although this product features patented or proprietary protection circuitry, damage may occur on devices subjected to high energy ESD. Therefore, proper ESD precautions should be taken to avoid performance degradation or loss of functionality.

Legal Terms and Conditions

By using the evaluation board discussed herein (together with any tools, components documentation or support materials, the "Evaluation Board"), you are agreeing to be bound by the terms and conditions set forth below ("Agreement") unless you have purchased the Evaluation Board, in which case the Analog Devices Standard Terms and Conditions of Sale shall govern. Do not use the Evaluation Board until you have read and agreed to the Agreement. Your use of the Evaluation Board shall signify your acceptance of the Agreement. This Agreement is made by and between you ("Customer") and Analog Devices, Inc. ("ADI"), with its principal place of business at One Technology Way, Norwood, MA 02062, USA. Subject to the terms and conditions of the Agreement, ADI hereby grants to Customer a free, limited, personal, temporary, non-exclusive, non-sublicensable, non-transferable license to use the Evaluation Board FOR EVALUATION PURPOSES ONLY. Customer understands and agrees that the Evaluation Board is provided for the sole and exclusive purpose referenced above, and agrees not to use the Evaluation Board for any other purpose. Furthermore, the license granted is expressly made subject to the following additional limitations: Customer shall not (i) rent, lease, display, sell, transfer, assign, sublicense, or distribute the Evaluation Board; and (ii) permit any Third Party to access the Evaluation Board. As used herein, the term "Third Party" includes any entity other than ADI, Customer, their employees, affiliates and in-house consultants. The Evaluation Board is NOT sold to Customer; all rights not expressly granted herein, including ownership of the Evaluation Board, are reserved by ADI. CONFIDENTIALITY. This Agreement and the Evaluation Board shall all be considered the confidential and proprietary information of ADI. Customer may not disclose or transfer any portion of the Evaluation Board to any other party for any reason. Upon discontinuation of use of the Evaluation Board or termination of this Agreement, Customer agrees to promptly return the Evaluation Board to ADI. ADDITIONAL RESTRICTIONS. Customer may not disassemble, decompile or reverse engineer chips on the Evaluation Board. Customer shall inform ADI of any occurred damages or any modifications or alterations it makes to the Evaluation Board, including but not limited to soldering or any other activity that affects the material content of the Evaluation Board. Modifications to the Evaluation Board must comply with applicable law, including but not limited to the RoHS Directive. TERMINATION. ADI may terminate this Agreement at any time upon giving written notice to Customer. Customer agrees to return to ADI the Evaluation Board at that time. LIMITATION OF LIABILITY. THE EVALUATION BOARD PROVIDED HEREUNDER IS PROVIDED "AS IS" AND ADI MAKES NO WARRANTIES OR REPRESENTATIONS OF ANY KIND WITH RESPECT TO IT. ADI SPECIFICALLY DISCLAIMS ANY REPRESENTATIONS, ENDORSEMENTS, GUARANTEES, OR WARRANTIES, EXPRESS OR IMPLIED, RELATED TO THE EVALUATION BOARD INCLUDING, BUT NOT LIMITED TO, THE IMPLIED WARRANTY OF MERCHANTABILITY, TITLE, FITNESS FOR A PARTICULAR PURPOSE OR NON-INFRINGEMENT OF INTELLECTUAL PROPERTY RIGHTS. IN NO EVENT WILL ADI AND ITS LICENSORS BE LIABLE FOR ANY INCIDENTAL, SPECIAL, INDIRECT, OR CONSEQUENTIAL DAMAGES RESULTING FROM CUSTOMER'S POSSESSION OR USE OF THE EVALUATION BOARD, INCLUDING BUT NOT LIMITED TO LOST PROFITS, DELAY COSTS, LABOR COSTS OR LOSS OF GOODWILL. ADI'S TOTAL LIABILITY FROM ANY AND ALL CAUSES SHALL BE LIMITED TO THE AMOUNT OF ONE HUNDRED US DOLLARS (\$100.00). EXPORT. Customer agrees that it will not directly or indirectly export the Evaluation Board to another country, and that it will comply with all applicable United States federal laws and regulations relating to exports. GOVERNING LAW. This Agreement shall be governed by and construed in accordance with the substantive laws of the Commonwealth of Massachusetts (excluding conflict of law rules). Any legal action regarding this Agreement will be heard in the state or federal courts having jurisdiction in Suffolk County, Massachusetts, and Customer hereby submits to the personal jurisdiction and venue of such courts. The United Nations Convention on Contracts for the International Sale of Goods shall not apply to this Agreement and is expressly disclaimed.