

Welcome to the Digital Sandbox!

When partnered with the Digital Sandbox, this guide helps to introduce the fundamental concepts of programming and electronics. Using ArduBlock – a simple, graphical version of the popular Arduino programming language – you will program 13 experiments that progressively explore subjects like digital inputs, analog outputs, serial communication and more. The experiments are project-based, and are built to inspire inventions such as reaction-testing games, automatic night lights, adjustable volume meters and more.

2	The Anatomy of the Digital Sandbox
4	Digital Sandbox Baseplate Setup
5	Setting up Arduino and ArduBlock
7	Experiment 0: Setup, Loop, and Blink
11	Experiment 1: Exploring Blink
15	Experiment 2: Multi-Blink
19	Experiment 3: Dimming (the Hard Way)
23	Experiment 4: Dimming (the Easy Way)
27	Experiment 5: Color Mixing
31	Experiment 6: Number Storage with Variables
35	Experiment 7: If This, Then That
39	Experiment 8: The Reaction Tester
43	Experiment 9: Serial Calculator
47	Experiment 10: Do the Analog Slide
51	Experiment 11: Automatic Night Light
55	Experiment 12: Thermal Alert!
59	Experiment 13: Sound Detecting
Bonus add-on experiments (parts not included):		
63	Experiment 14: Opto-Theremin
69	Experiment 15: Serial Motoring
75	Experiment 16: Servo Sweeper

① USB Mini-B Connector

Used to connect to a computer

② JST Right-Angle Connector

Used to supply power to the board

③ Slide Switch for Charging

Used to charge a lithium polymer battery that is plugged into the two-pin JST connector, while the Digital Sandbox is connected to a computer and the slide switch is in the "ON" position

④ Reset Button

This is a way to manually reset your Digital Sandbox, which will restart your code from the beginning.

⑤ Slide Switch (Pin D2)

On or off slide switch.

⑥ LEDs (Pins D4-D8)

Use one or all of the LEDs (light-emitting diodes) to light up your project!

⑦ LED (Pin 13)

Incorporate this into your sketch to show whether your program is running properly.

⑧ Temperature Sensor (Pin A0)

Measures ambient temperature

⑨ Light Sensor (Pin A1)

Measures the amount of light hitting the sensor

⑩ RGB LED (Pins D9-D11)

RGB (red-green-blue) LEDs have three different color-emitting diodes that can be combined to create many colors.

⑪ Slide Potentiometer (Pin A3)

Change the values by sliding it back and forth.

⑫ Microphone (Pin A2)

Measures how loud something is

⑬ Push Button (Pin D12)

A button is a digital input. It can be either "on" or "off."

⑭ Add-on Header (Pin D3)

Three-pin header for add-ons. Example add-ons are servos, motors and buzzers.

Digital Sandbox Baseplate Setup

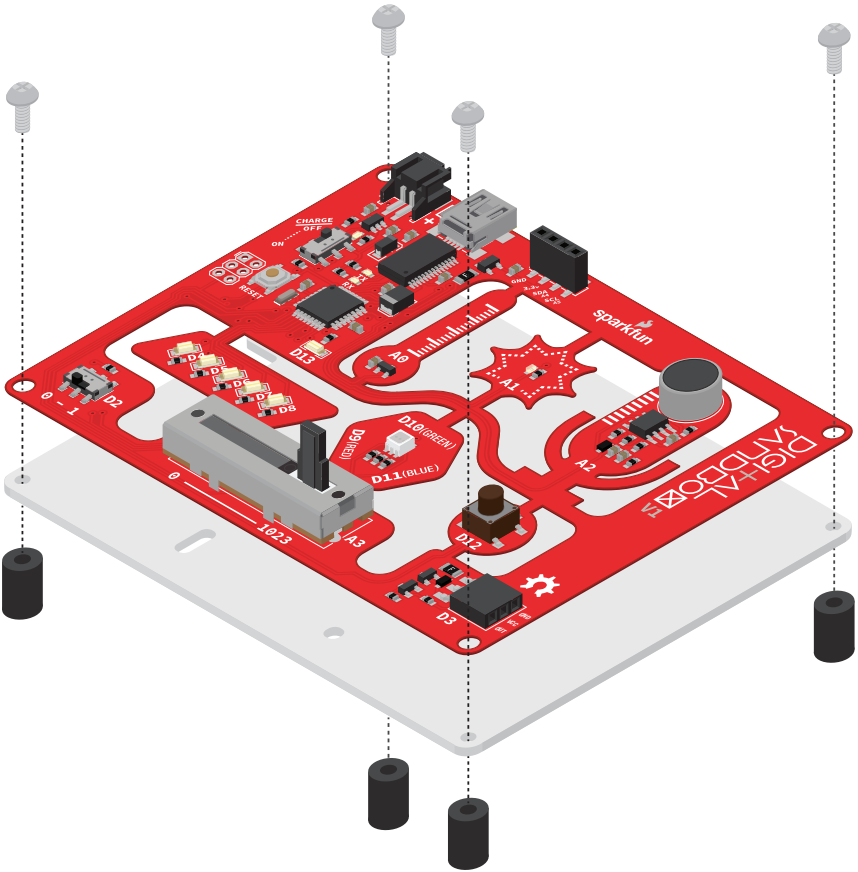

Secure the Digital Sandbox board to the baseplate

The Digital Sandbox board can be attached with the included Phillips-head screws for easy removal later.

Download the Arduino/ArduBlock Combo

Arduino and ArduBlock are available for all popular operating systems. To download Arduino and ArduBlock, please go to:

www.sparkfun.com/digitalsandbox

Make sure you grab the version that matches your operating system.

The Arduino software comes packaged in an archived **.ZIP** format. Once you've downloaded the **ZIP** file, you'll need to **extract it**.

Mac users: Move the **Arduino** application into the **Applications** folder. Move the **Digital Sandbox Examples** folder to your preferred location.

Windows users: Move the *Arduino* folder to your preferred location.

Install Drivers

Once you have downloaded and extracted the Arduino software, connect the **Digital Sandbox to your computer**.

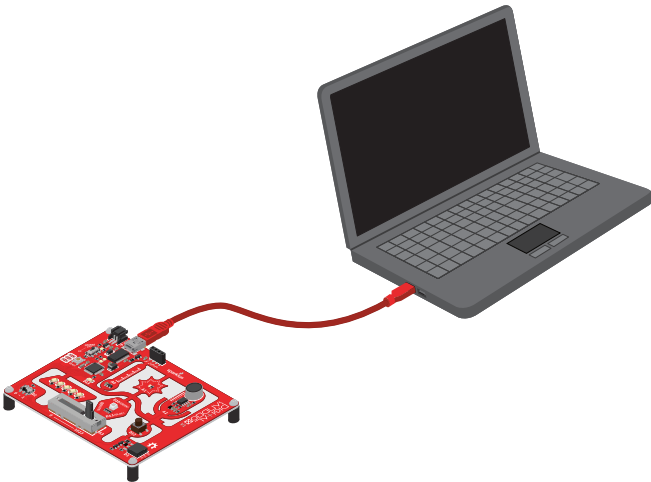

Once the board is connected, you will need to install drivers. For instructions specific to your operating system, please go to:

www.sparkfun.com/ftdi

Open Arduino and ArduBlock

ArduBlock is an add-on that exists inside the Arduino software. To open it, first open the Arduino IDE. Windows users should run *Arduino.exe*; Mac users can run the *Arduino* application.

Setting up Arduino and ArduBlock

Let's do some preparation before opening ArduBlock. First, go to the **Tools** menu, hover over **Board** and select **Digital Sandbox**.

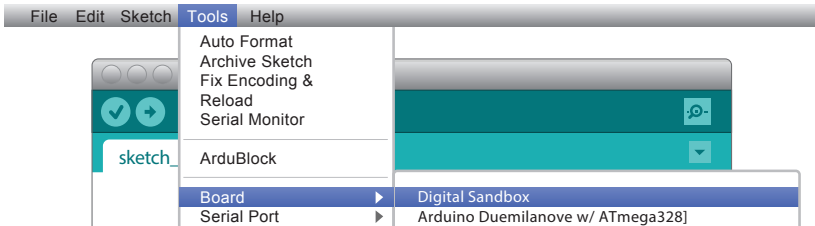

Next, go back to the **Tools** menu, hover over **Serial Port** and select the serial port number that matches your Sandbox board.

Window users: This is likely to be COM3 or higher (COM1 and COM2 are usually reserved for hardware serial ports). To find out, you can disconnect your Sandbox and re-open the menu; the entry that disappears should be the Sandbox. Reconnect the board and select that serial port.

Mac users: On the Mac, this should be something with `/dev/tty.usbmodem` or `/dev/tty.usbserial` in it.

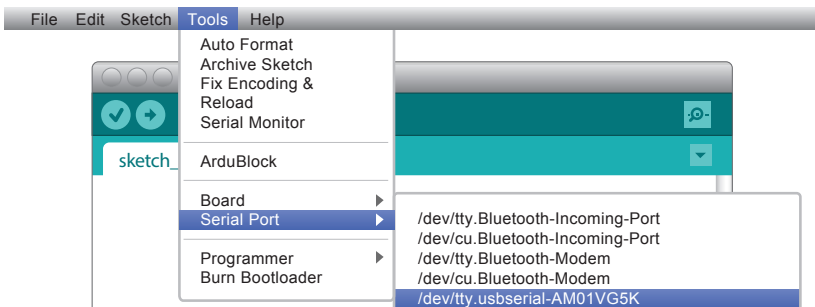

Finally, to open ArduBlock, go to **Tools** and select **ArduBlock**.

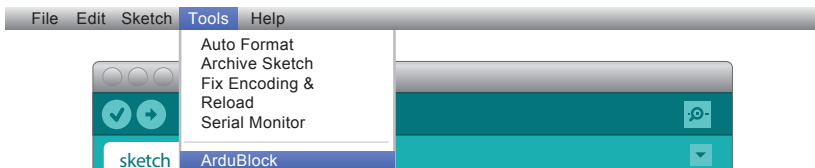

What opens next is the ArduBlock interface. Make sure the Arduino window remains running in the background. If you close that, ArduBlock will close as well.

Note: If you don't see *ArduBlock* under the *Tools* menu, you may need to manually install it. For help adding ArduBlock to a previous Arduino installation, please visit:

www.sparkfun.com/ardublock

0: SETUP, LOOP, AND BLINK

When faced with a new platform, a coder's first task is to write a "Hello, world" program. Usually a "Hello, world" program actually displays those comforting words on a screen. The Digital Sandbox doesn't give us a screen to display words on, but we do have LEDs: wonderful, blinky, bright and shiny LEDs. Instead of words, let's blink an LED to say, "Hello, world."

Active Parts

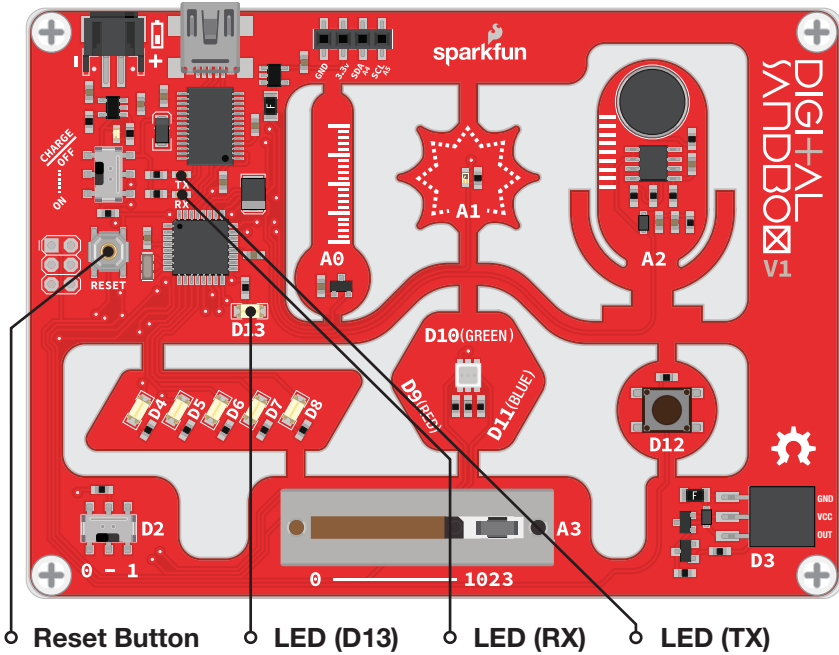

Background Information

This experiment introduces the general concept of **physical** programming. Changes you make in your program will actually affect what's happening **on** the Digital Sandbox board.

This drawing also serves to introduce a couple of the most fundamental Arduino programming concepts: *setup* and *loop*.

Please note: You can continue with the **Code Components** section to see what blocks you will need for this experiment. Each experiment also has its own saved file with all the experiment's blocks already set up, so you can get started faster or troubleshoot if needed. To open this experiment, click the **Open button** in ArduBlock. Then, go to the **Digital Sandbox Examples** folder in the same location where you moved the folder during the initial setup. From there, you will open the corresponding experiment file. For example, **00_setup_loop_blink.abp** is for Experiment 00.

Code Components

This code drawing requires **two blocks** (well, sort of three):

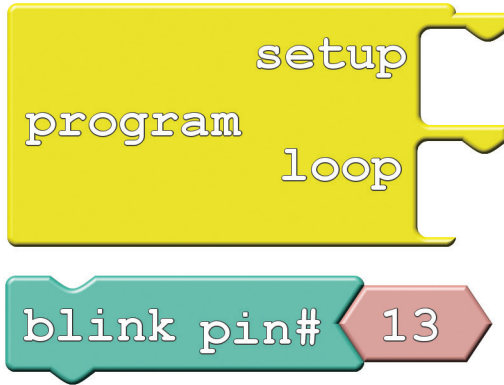

- **Program:** This block is **required** for every single ArduBlock drawing! You can only have one per drawing. *Program* always has two slots for blocks – one named "setup" and another named "loop." Find this block under the **Control** bin.
- **Blink:** Find this block under the **Pins** bin. This block “blinks” a pin on the Digital Sandbox. The *Blink* block actually gives you *two* blocks for the price of one! It also includes a pink block with the number 13 inside it. Leave that block alone for now; we'll discover its use in later experiments.

Do This

With this pair of blocks, there are only two functional drawings that we can create. You can either stick the *Blink* block under the *setup* section of *Program*, or under the *loop* section.

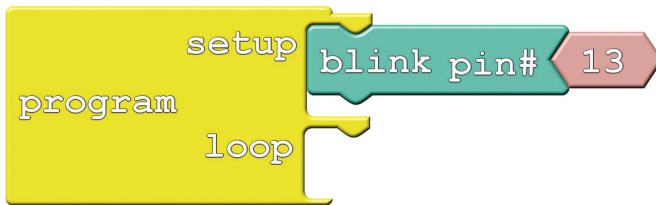

OR



Experiment 0: Setup, Loop, and Blink

Try sticking the *Blink* block **under** *setup*, then **click the Upload to Arduino button**.



Keep your eyes glued to the Digital Sandbox as the code uploads. You'll see the red and green RX and TX LEDs blink like crazy as code is sent from your computer to the Digital Sandbox. Pay extra close attention to what happens after the red and green LEDs do their dance. Do you notice anything?

Now **move** the *Blink* block from *setup* to *loop*, and do the **Upload to Arduino** jig again. Notice anything different?

Every Arduino program requires that two functions **always** be present: *setup* and *loop*. From the names of these functions, it should be pretty clear what their job is.

Setup runs once, at the very beginning of the program. Its purpose is usually to set the platform up for the rest of its lifecycle (until the Sandbox is reset, or loses power). As we continue on with these experiments, you'll have a greater understanding of what kinds of things need to be set up in advance.

If *setup* sets the Sandbox up, *loop* must... **loop**. Code in this block will execute sequentially and endlessly. Once we get to the bottom of *loop*, we jump right back up to the top and do it all over again. This looping will continue until you either reset or remove power.

Further Explorations

- What happens when you press the **reset button**?
- What happens if there's nothing in either the *setup* or *loop* (move the *Blink* block out)?
- What happens if you add a **second** *Blink* block to the drawing? Regardless of where you put it, can you discern which of your *Blink* blocks are being executed?
- What do you think the **13** inside the *Blink* block is for?

1: EXPLORING BLINK

Now, we didn't exactly cheat in experiment 0, but the Blink block was a bit of a shortcut. What if you wanted to speed up the blinking? Or change how long it's on, versus how long it's off? Or even blink something other than that wimpy, little red LED?

Active Part

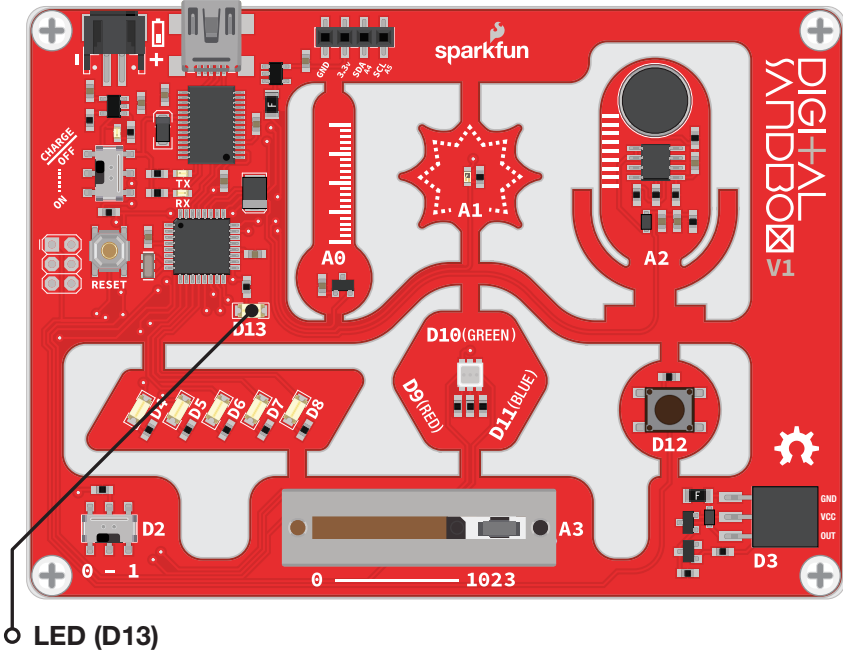

Background Information

This experiment digs into the anatomy of the *Blink* block. We can customize an LED blink with a combination of two blocks – *Set Digital Pin* and *Delay Milliseconds*.

This experiment introduces the concept of **digital output**. We call the Sandbox’s LEDs “outputs” because it’s an effect that the board produces.

The term “digital” means that the output can only take **one of two states**: ON or OFF. We may also refer to those two opposing states as HIGH/LOW or 1/0. When an output connected to an LED is HIGH, the LED turns on. When the output is LOW, the LED turns off.

Code Components

Here is the set of blocks we'll use to create this drawing:

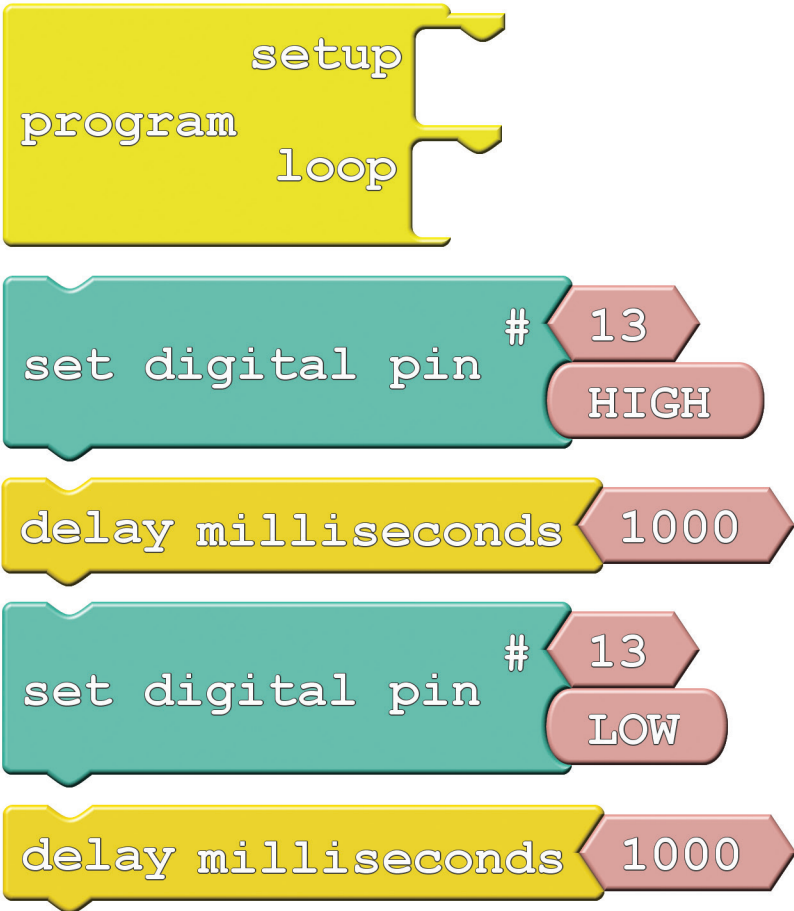

Aside from *Program* block, which you should include in every drawing, there are two new blocks to be added:

- **Set Digital Pin:** This block **sets an output** to either HIGH or LOW, so it can be used to turn the LED on or off. Find this block under the **Pins** bin. When you drag this block over, it includes a pair of pink blocks containing “13” and “HIGH.” Let’s only concern ourselves with the bottom pink block for now.
- **HIGH/LOW block:** If you mouse over this block, a drop-down arrow will appear. Click the arrow and you can change the value of the block to either “HIGH” or “LOW.” This determines which of the two states you’re setting the digital output to.

Experiment 1: Exploring Blink

- **Delay Milliseconds:** The Digital Sandbox runs code so fast that sometimes we need to slow it down with a delay. This block will halt the Sandbox from doing anything for a specified number of milliseconds. There are 1000 milliseconds (ms) in a second, so delaying for 1000ms will stop for 1 second. Find this block under the **Control** bin.
-

Do This

Organize and snap together the *Set Digital Pin* and *Delay Milliseconds* blocks so they alternate – teal, yellow, teal, yellow. Then put the group of four blocks in the *loop* section of the *Program* block. Then, **upload** the code.

You should see a very familiar sight. But this time you have control over the blink rate! Adjust the value in the *Delay Milliseconds* block(s). What happens if you make the delays shorter? What happens if the two delays are not for the same amount of time?

The Digital Sandbox operates at 8MHz – there's a clock in there that ticks eight million times per second. That means it can run millions of lines of code per second. Without any delays in the program, the digital output would flick on and off so fast you wouldn't be able to tell if it's actually on or off.

Further Explorations

- How short can you make the delays and still notice a blink (10ms? 1ms)?
- What happens if you take the *Delay Milliseconds* block out of the program?
- While digging around for the *Delay Milliseconds* block, you may have discovered a *Delay Microseconds* block as well. What happens if you swap that in?

2: MULTI-BLINK

Large arrays of LEDs are often used to create massive outdoor signs and animations, because they're both bright and efficient. While we don't have the millions of LED pixels that a display in Times Square might have, we can still create some fun patterns with the Digital Sandbox.

Active Parts

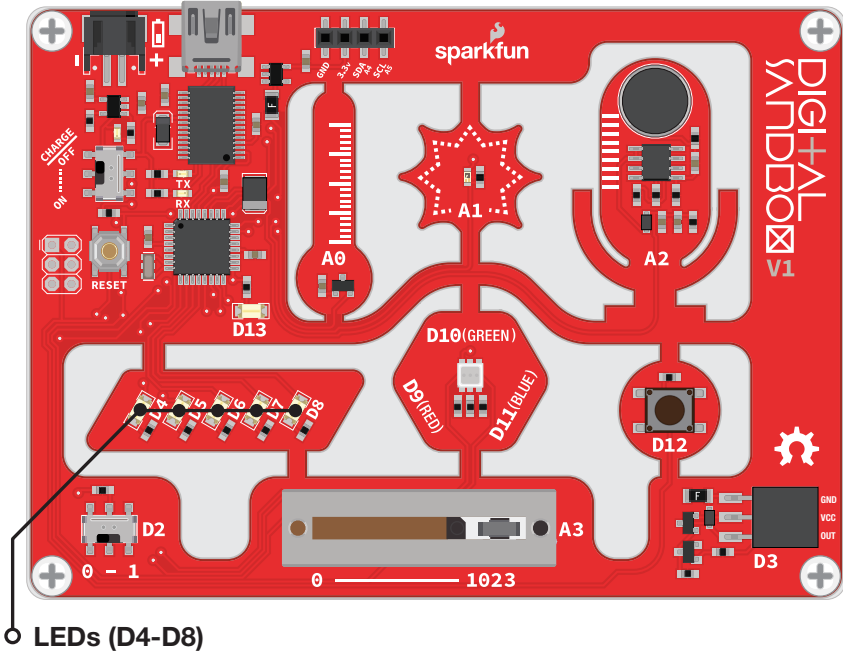

Background Information

In this experiment we explore the subject of **pins** - the manipulators of the Sandbox. Each LED (as well as the other inputs and outputs on the Digital Sandbox) is connected to a specific pin on the Sandbox's microcontroller.

Pins are all **uniquely numbered**, and each input or output component on the Sandbox is labeled with the pin number it's connected to - that's the *D2*, *D4*, *D11*, *A1*, etc. lettering next to each LED, switch and sensor.

Every pin can be separately controlled; for instance pin 4 can be set HIGH at the same time pin 5 is set LOW. Some pins (as we'll later discover) have special powers, but every pin is at least able to accomplish digital input and output.

Code Components

Whoa! Block explosion! This experiment calls for sixteen total blocks:



Experiment 2: Multi-Blink

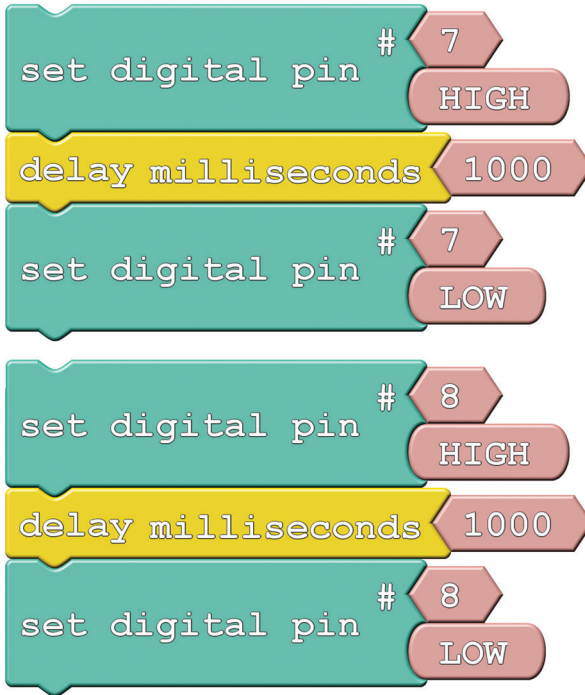

Instead of introducing a new block, we'll be adjusting the value of *Set Digital Pin's* top pink *Pin Number* block. This value specifies which of the Sandbox's pins we'll be toggling.

Do This

In our unfinished example, the blocks are all arranged in groups of three. Each group begins by setting a pin HIGH, then delays for a second and sets it back to LOW. Notice that each group of three toggles a different pin, ranging from pin 4 to pin 8. **Stack the groups of three** on top of each other in the *loop*, then **upload** and enjoy the exciting animation.

If the LED slide is too slow for you, try adjusting the delays to make it faster. Or perhaps you want to change the pins to adjust the order of the blinks?

Further Explorations

- Try adding more blocks to create slicker patterns. Can you make a Larson scanner (ask an old person about Cylons or Knight Rider)? A chaser? Flip from odds to evens?
- Try turning on more than one LED at a time. Turn them all on (and shield your eyes)!

3: DIMMING (THE HARD WAY)

Yikes! Those white LEDs are blindingly bright! Is there any way to dim them? Unless one of your hobbies is staring into the sun, we recommend putting a piece of paper over the LEDs in this experiment. . . or wear sunglasses.

Active Parts

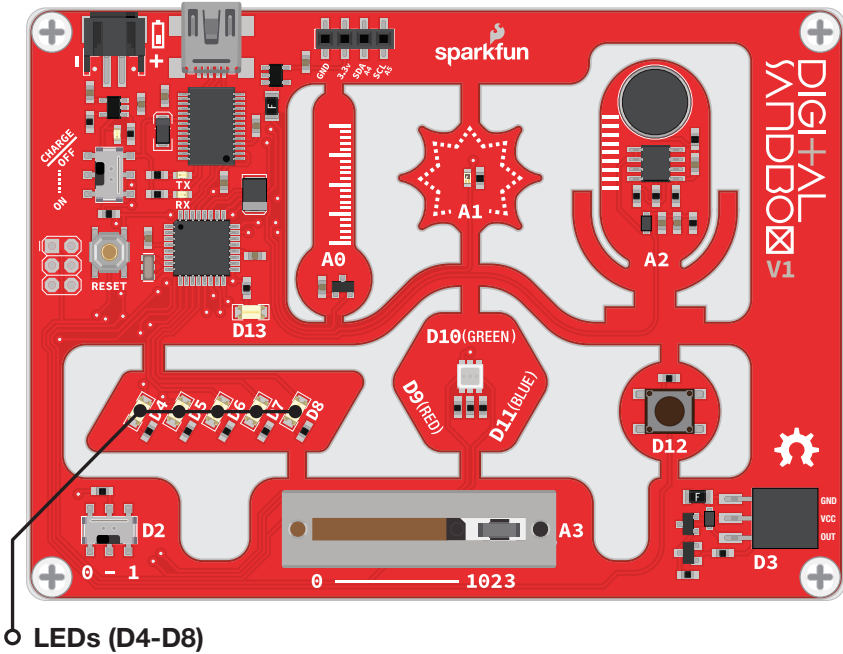

Background Information

Remember that the Digital Sandbox is **fast**. It can flick an LED on and off millions of times per second. What if we blinked the LED super fast, but also made it so the time it's off was more than the time it was on? This is called **pulse-width modulation (PWM)**, a tool with a variety of applications, including the **dimming** of LEDs.

In this experiment we'll explore PWM the hard way, by coding it in manually.

Code Components

We'll use a similar set of blocks:

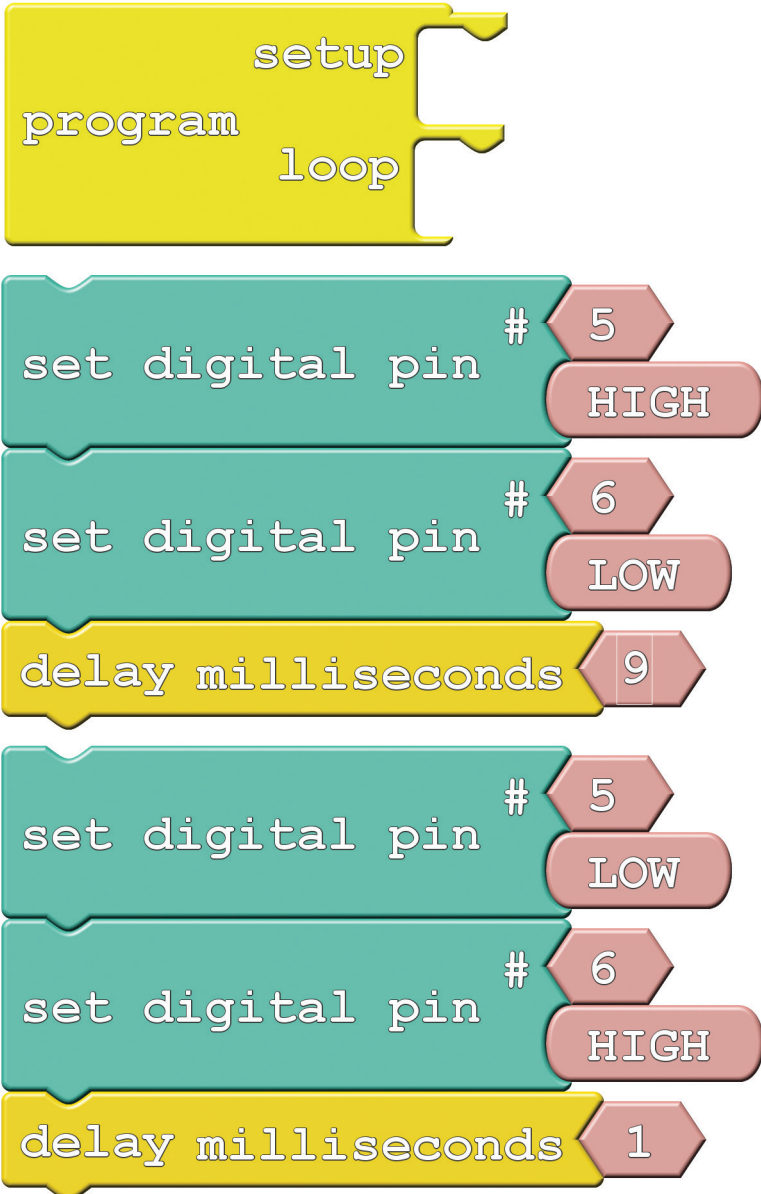

Take note of how long each delay is, and which pins are on/off in each group.

Do This

Stack the two groups of three on top of each other in the *loop* section, and **upload**.

After uploading, take a close look at the LEDs connected to pins 5 and 6. Can you spot a difference between the two? The D6 LED should look dimmer in comparison to D5. That's because D6 is set to be low 90% of the time, and on only 10%. It's blinking on and off so fast that you can't notice, and the blinking is creating a dimming effect.

What happens if you swap the two *Delay Milliseconds* blocks? What if you change the values in each of the delay blocks (try to keep the sum of delay times to around 10ms)?

Further Explorations

- How long can you make the delays before you start noticing a blink?
- Try comparing both LEDs to a fully-on LED. Add a *Set Digital Pin* block to the *setup*, and have it turn the D4 LED HIGH. Can you tell a difference between D4, D5 and D6?
- What happens if you add something else to the *loop* section, like your animation from Experiment 2?

4: DIMMING (THE EASY WAY)

Manual PWM is hard, and it doesn't leave room for anything else in the program. Why can't we offload that chore to the Digital Sandbox's microcontroller? It's smart enough for that...right?

Active Parts

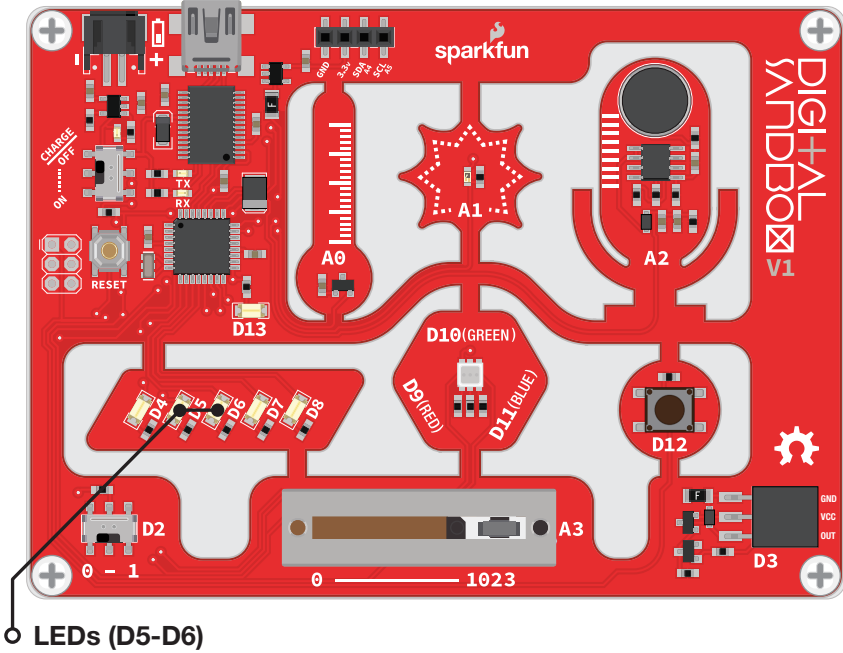

Background Information

PWM is such a popular tool many microcontrollers implement special hardware so they can mindlessly toggle the pin while doing something else. We call this PWM-based output "**analog output.**"

Unlike *digital* outputs, which only have two possible values, analog outputs have a huge range of possible values. On the Sandbox, we can analog-ly output **256 different values**. If we set an analog output to 0, that's like setting a pin LOW, and 255 is like setting a pin HIGH, but all of the values in between produce an output that's neither HIGH or LOW – it's somewhere in between.

Analog output seems great – why wouldn't you use it all the time? Unfortunately, not all pins have special PWM powers. Only pins 3, 5, 6, 9, 10 and 11 are able to produce analog outputs.

Code Components

New block alert! While it may look similar, we'll be using *Set Analog Pin* this time instead of its digital counterpart:

```

  setup
  program
  loop

```

```

  set analog pin # 5
                0

```

```

  delay milliseconds 1000

```

```

  set analog pin # 5
                64

```

```

  delay milliseconds 1000

```

```

  set analog pin # 5
                128

```

```

  delay milliseconds 1000

```

Experiment 4: Dimming (the Easy Way)



- **Set Analog Pin:** This block looks a lot like the *Set Digital Pin* block. We still tell it which pin to control, but instead of a restrictive, digital output option, we get to choose any number between 0 and 255 for the output. Find this block under the **Pins** bin.

Do This

Stack the blocks in the *loop* section. Order them so the analog values go from 0 at the top to 255 at the bottom. Then, upload away!

The LED on pin 5 should cycle through five different levels of brightness (including fully on and fully off). Remember that setting the analog output to 0 turns the LED off, and 255 is like setting it to HIGH.

Try adding analog control of the pin 6 LED to the drawing. You can create the same effect from the last experiment with just two lines of code (and you can execute other code while the LEDs remain in their dimmed state).

Further Explorations

- What's the dimmest value you can assign to the LED and still see it on?
- Why do you think there are 256 possible analog output values? That doesn't seem like a very round number (hint: 2^8).

5: COLOR MIXING

Bleh...white. So boring. Let's add some color to this Sandbox! By combining analog output with an RGB LED, we can mix varying levels of red, green and blue to create a rainbow of colors!

Active Part

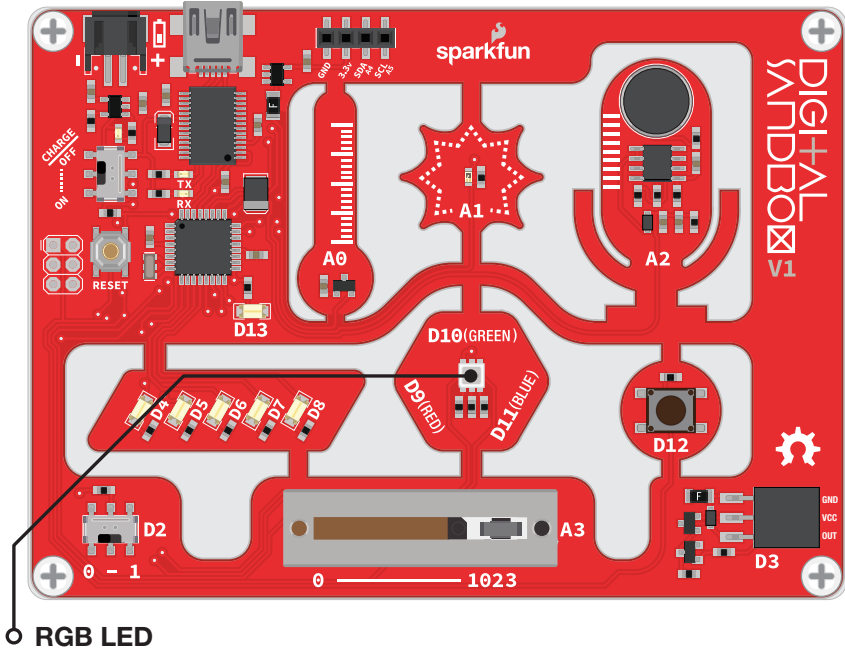

Background Information

In art class you probably learned about **primary colors** and how you can mix them to produce any other color. While the artsy primary colors you might be familiar with are red, yellow and blue, in electronics (and programming in general), our primary colors are red, green and blue.

By selecting different analog levels for our primary colors, we can mix them to create any other color we want. Need yellow? Mix green and red. Purple? Red and blue. In this experiment we'll combine everything we've learned about analog output to add custom color to the Digital Sandbox.

Code Components

For the most basic RGB color-mixing sketch, this is all we need:

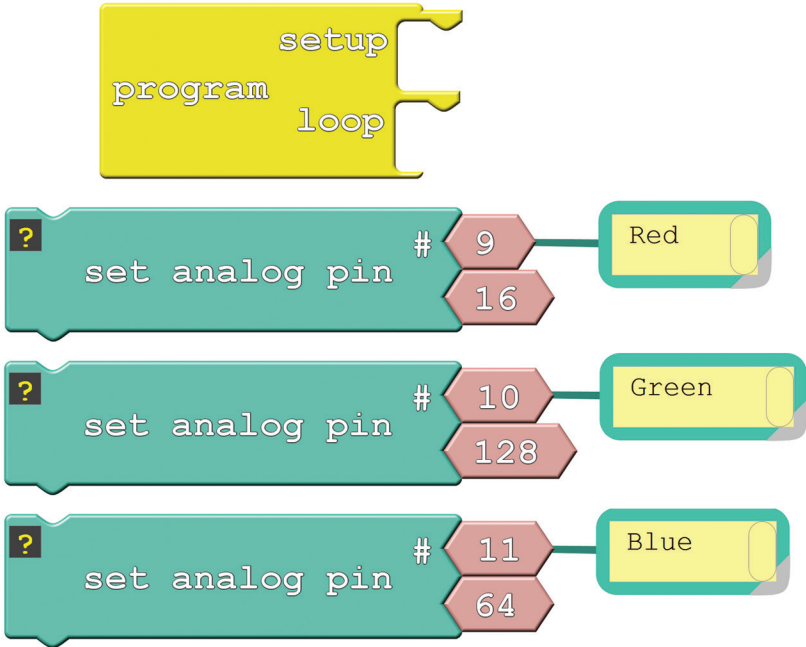

In the example, we added **comments** to each of the *Set Analog Pin* blocks. Comments have no effect on the actual code, but they do help make the code more readable to you or others. With those blocks commented, we don't have to look back at the board to remember which pins go to which colors.

You can add comments by right-clicking on a block, and selecting "Add Comment." Show or hide comments by clicking the question mark.

Do This

Stack those three *Set Analog Pins* on top of each other, in either the *setup* or the *loop*. This will set red's value to 16, green to 128, and blue to 64. What color do you think it'll make? Upload to find out (if it's hard to tell what the color is, put a piece of paper over the RGB LED).

Play with the analog values to make your own colors. How about purple, or orange, or salmon? You can take it even further by adding delays, and blinking different colors to make animations.

Further Explorations

- Mix the colors to make your favorite color. Or, if your favorite color is red, green or blue, try making your least favorite color.
- Make a stop light blink from green, to yellow, then quickly to red and repeat.

6: NUMBER STORAGE WITH VARIABLES

The herky-jerky fading from Experiment 4 accomplished the task, but just think of all the values we were missing! How do we make the LED fade smoothly? You can whip out 256 minutely different *Set Analog Pin* blocks, or you can reduce it to one, using variables.

Active Parts

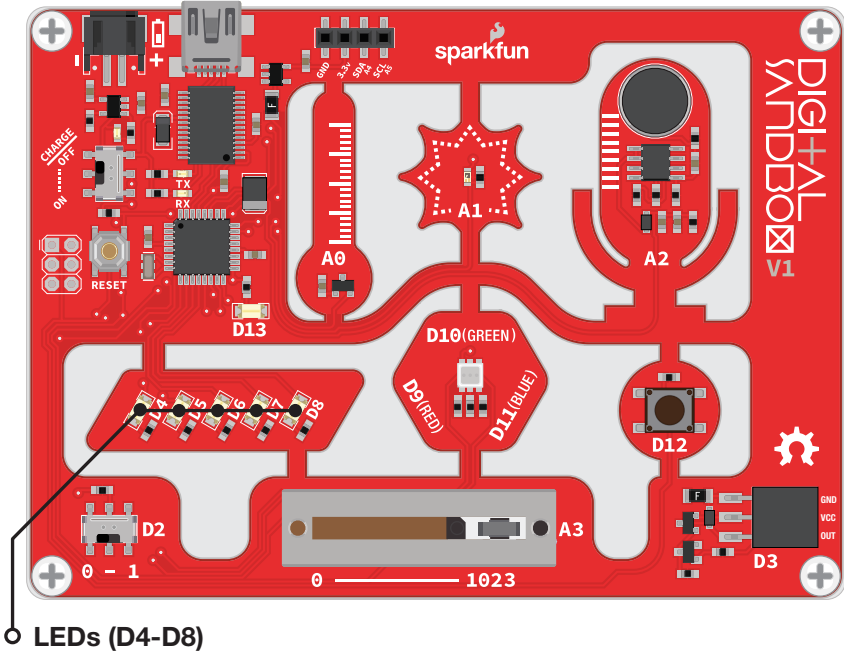

Background Information

Variables are like storage containers for numbers. We can put any number in a variable, and either recall it and put it to use, or manipulate it to change the value it stores. Anywhere you stick a literal number (like “0” or “255”) you can instead use a variable.

There are a few rules when it comes to creating a variable. They can be any word, but they must begin with a letter, and they can’t have spaces (use “_” instead). They are **case sensitive**, so a variable named “fade” isn’t the same variable as “Fade.” Try to keep variables short, but use descriptive words to keep your code legible.

Code Components

Thanks to variables, here are all the blocks we need to create a smooth fade:

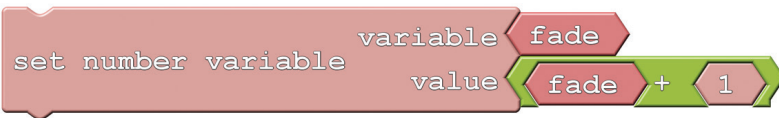
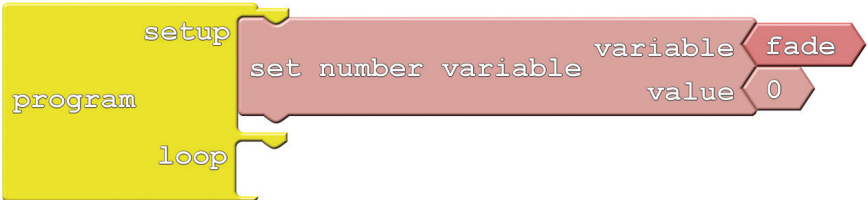

There are a few new blocks to familiarize yourself with this time:

- Number Variable Name:** These blocks are about the same size and shape as the literal number blocks we've been using. But, instead of writing a number in these blocks, you type in the **name** for your variable. Make sure it's spelled the same in every place you want to reference it! You can find this block under the **Variables/Constants** bin on the left.
- Set Number Variable:** This block, also found under the Variables/Constants bin, is used to **set a variable to a specific value**. Two blocks snap to this one – a **variable name** on top, and the **value** you want to set that variable to on the bottom. The value can be a literal number, another variable, or the result of a mathematical operator.
- Math operator block:** If you click on the **Math Operators** bin and look at the first four entries, you should see some very familiar symbols: +, -, ×, and ÷. These math operators can be used to do math on a pair of variables, numbers, or a combination of the two.

Do This

Add the first *Set Number Variable* block, which will include a blank variable and a value. Click into the *number variable name* and write “fade” into it. The “fade” variable will keep track of the the brightness of our LED. The *Set Number Variable* block in the *setup* area of the program should set the “fade” variable to 0.

You should be familiar with *Set Analog Pin* and *Delay Milliseconds*; grab those blocks and stick them in the *loop* in either order.

We'll need to **throw away** the value block that comes with *Set Analog Pin* (drag it over to the left side of the window) and replace it with a variable. To add a variable to your sketch, drag over the *Number Variable Name* block and type your variable's name into it. Alternatively, once you've made one variable, you can **right-click** on it and **clone** it to get more of the “fade” variables you'll need.

Finally, add another *Set Number Variable* block, and replace the 0 value it includes with a + **operator**. Modify it so it adds a 1 to “fade,” and plug it into the *value* part of the *Set Number Variable* block. Then stick that block group at the end of the *loop*.

Whew! Let's see what all that work was for by uploading the drawing. The LED on pin 5 should satisfyingly and smoothly flow from fully off to fully on.

Further Explorations

- Does it matter what order you have the *loop* blocks in?
- Can you make other LEDs fade? How about more than one fading at the same time?
- Can you make the LED fade from HIGH to LOW? Hint: You may need to change the setup value of “fade,” and change the + to a -.

7: IF THIS, THEN THAT

Fading from the last experiment was working just fine until we got to the maximum brightness level of 255. What happens then is a mystery known only to the compiler (and you, once you learn a little something about data types). What *if* we added “catch” to force that *fade* variable to reset when it hits a certain value?

Active Part

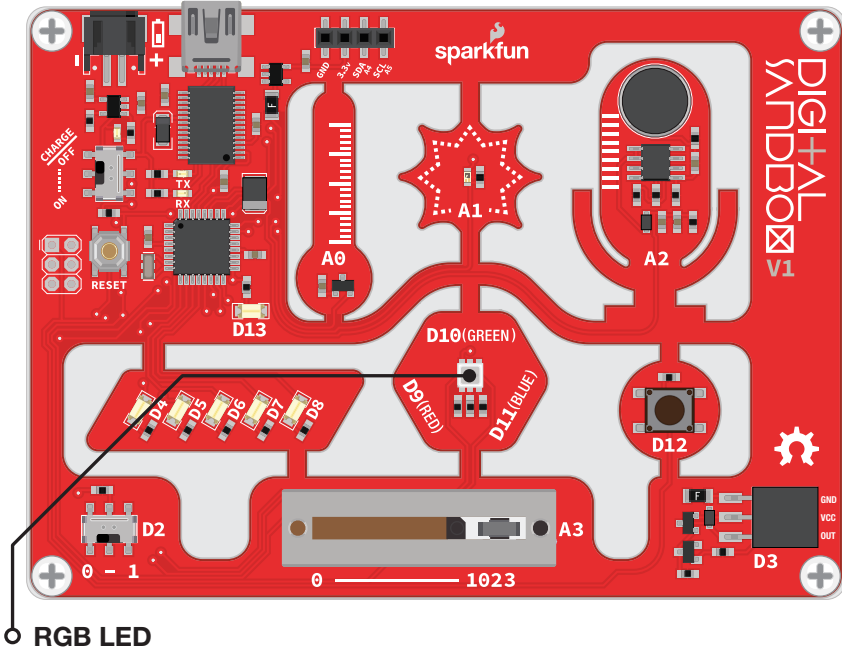

Background Information

This experiment introduces the **if statement**, one of the most fundamental programming structures. Not only are *if* statements important for computers, they also rule most of the decisions we make in our lives. *If* it's cloudy outside, *then* pack your umbrella. *If* you're hungry, *then* make a sandwich. Like us, computers use *if* statements to make choices.

An *if* statement requires two components to be complete: a **condition** and a **consequence**. A condition is a value or mathematical operation that evaluates to either **true** or **false**. *If* the condition evaluates to true, then the consequence is executed. The consequence can be a code block of any size – one block or hundreds of blocks.

If the condition in the *if* statement is false, then the consequence is skipped, and the program starts running the code following the *if* block.

Code Components

Here are the blocks required to limit the fade value of our LED:

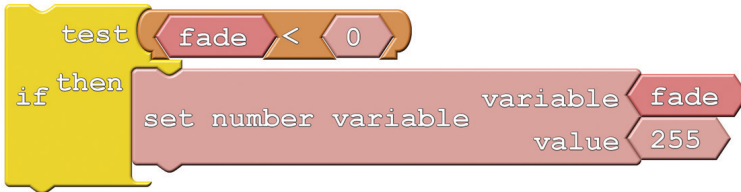
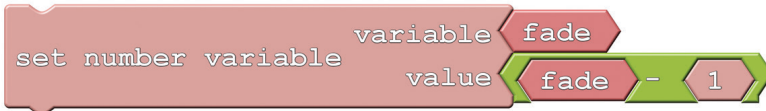
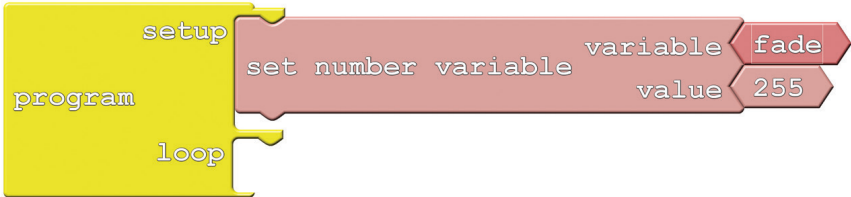

There are two new blocks to mention here:

- **If:** The star of this experiment can be found under the **Control** bin. The *If* block requires at least two blocks to be snapped into it: a **conditional** and the **consequence**. In this case, the consequence is just a single block – *Set Number Variable*. The conditional part of the *If* block is a logical operator block.
- **Logical Operator:** Logical operators are symbols which operate on one or two values and evaluate to **either true or false**, which makes them perfectly suited for the *if* statement conditional! In this case we'll be using the **less than** (<) operator. If the value to the left of the < symbol is less than the value on the right, then the operator is true. If the left is *not* less than (either greater than or equal to), then the condition will evaluate to false.

Do This

In this sketch, we want the green LED to progress from super-bright to off, and repeat that cycle endlessly. We'll use a variable called *fade* to keep track of the **analog output value**. At the very beginning of each loop, we'll subtract 1 from the *fade* variable.

Then, after subtracting from *fade*, we need to use an *if* statement to make sure it's not out of bounds. The *if* statement in this sketch states that **if *fade* is less than 0** (that would mean it's a *negative* number), **then set *fade* to 255**.

Once we've generated our *fade* value, we can set pin 10 (or pick another LED if you please) to that analog output value.

Snap together the *Set Number Variable*, *if* and *Set Analog Pin* block groups. Then put the group in the *loop* section of the *Program* block.

Now upload and enjoy a nice, controlled fade.

Further Explorations

- Can you make the fade work the **other way**? Start at 0, fade up to 255, and then go back to 0. Hint: you'll need to flip the logical operator around.
- Make it even smoother! Can you make it fade **smoothly up and smoothly down** in the same sketch? From 0 to 255, then 255 to 0, then 0 to 255, then back again.

8: THE REACTION TESTER

Computers are great at doing math and automating boring tasks, but everyone knows that their *true* purpose is to play games. Let's create a game on the Digital Sandbox! In order to control the game, we need to add **input**.

Active Parts

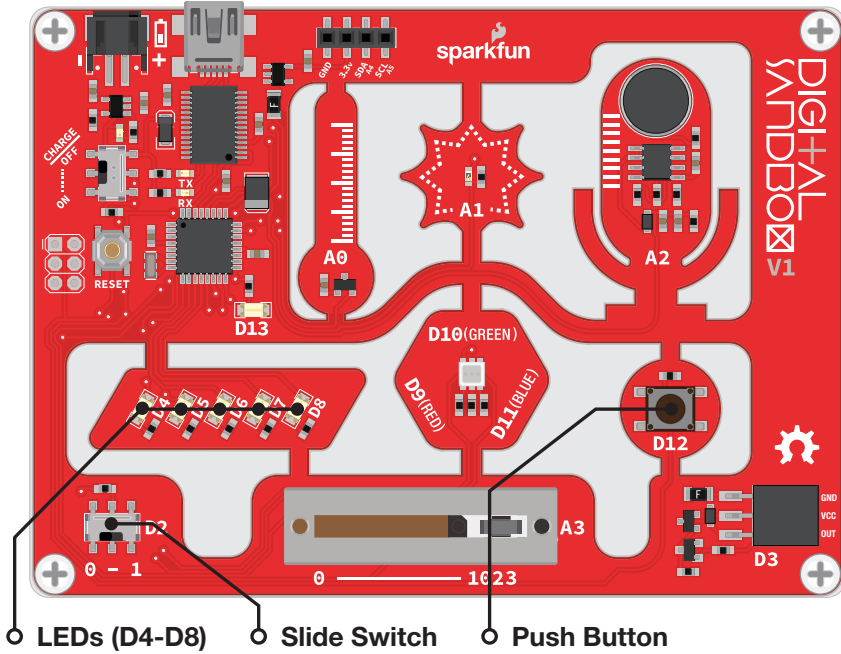

Background Information

Up to this point, our Digital Sandbox experience has been very one-sided: *output* to tiny yellow LEDs, *output* to larger white LEDs, *output* to RGB LEDs, change the fade value of the *output*. Output, output, output. Let's flip the tables on the Sandbox and send some **input** to the board!

Inputs are signals or values sent **into** a system. Some of the most common inputting components are buttons. Buttons on a keyboard are an **input** to your computer, because they send data into that system.

An *if* statement is critical to assessing the status of an input and taking an action based on it – if button A is pressed, then print an “a.” We can take the *if* statement a step further by adding an **else** condition, which allows us to control what happens if the *if* statement evaluates to **false**. So now we can say something like, “If the egg floats, throw it away; otherwise (else) fry it and eat!”

Please note: This experiment has a lot of blocks. Remember you can also open this experiment from the **Digital Sandbox Examples** folder, so you can get started faster or troubleshoot if needed.

Code Components

Our game will use both the switch (in the bottom left of the Sandbox) and the small button – components tied to pins D2 and D12, respectively. The sketch is pretty massive, so we'll snap it together for you. Here's what it looks like:

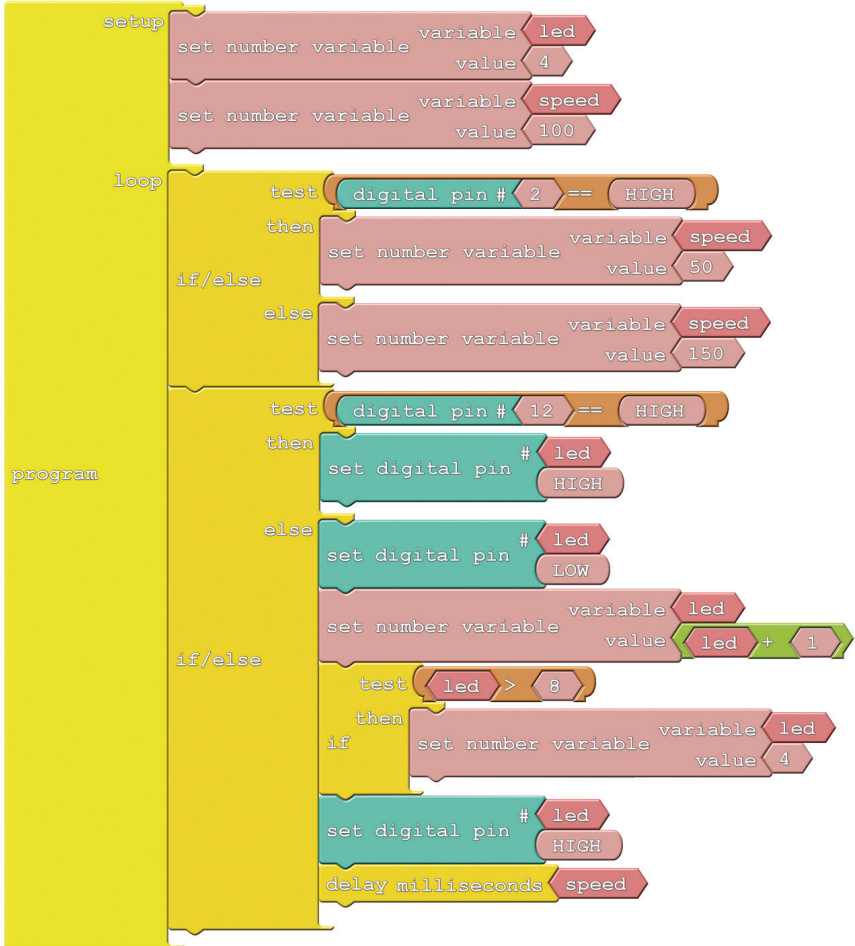

- If/Else:** This block works just like the *If* block, but it allows you to determine what happens if the conditional evaluates false in addition to true. Again, you need a conditional block (or set of blocks) that evaluate to either true or false in the *test* snap. You also need to add two separate blocks of code to fill both the *then* and *else* snaps.
- Equivalence test (==):** To test if two values are equivalent, we use the == statement. That's right, there are **two** equals signs. This is to differentiate from a single equals sign, which is used to set one value to another. The double equals is like asking, "Are these two values equal?"

Do This

Arrange your blocks so they match the image in the Code Component section. There are two important *if/else* statements in this program; each tests the status of an input. The top *If/Else* tests pin 2, which is connected to the switch. If the switch is set to 1 (e.g. HIGH), then we set a variable called *speed* to 50. If the switch is set to 0 (LOW), then *speed* becomes 150.

The second *If/Else* tests pin 12, which is tied to the small button. When the button is pressed, then the input is set to 1 (HIGH), and it's 0 when released. This means that when the button *is* being pressed, the code in the *then* will execute. When the button is *not* being pressed, the *else* blocks will run.

Can you guess what will happen in each of the pin 12 test cases? Upload the sketch to your board to find out!

This is a very simple game. Pick a number between 4 and 8, and try to make the LED stop on that number by pressing the button. To switch between easy and hard mode, move the switch from 0 to 1. Can you make it stop in the middle on hard mode?

Further Explorations

- Trick your friend and swap which direction of the switch sets it to easy mode – make 0 hard and 1 easy.
- Swap the function of the switch and the button. Make it so you have to press the button to set the difficulty, and flick the switch to stop the LEDs.

9: SERIAL CALCULATOR

While you probably can't have a very stimulating conversation with the Digital Sandbox, it can send you some very interesting information. It's great at math, so let's have the Sandbox do some calculating for us! Trouble is, how do we get it to print numbers (without Morse code)? Enter serial communication!

Active Part

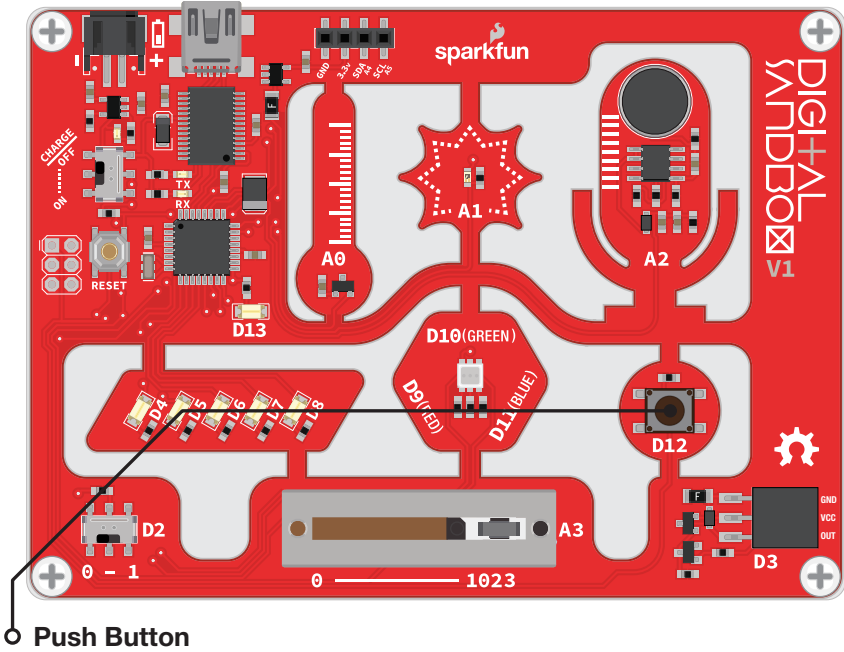

Background Information

Serial communication is a form of data transmission where we can send a string of 1's and 0's between two devices that actually forms a set of characters. So 01101000 01100101 01101100 01101100 01101111 00101100 00100000 01110111 01101111 01110010 01101100 01100100 becomes "Hello, world."

With serial, we can send actual text from the Sandbox and display it on our computer using the **Serial Monitor**.

Code Components

Here is the layout for this experiment:

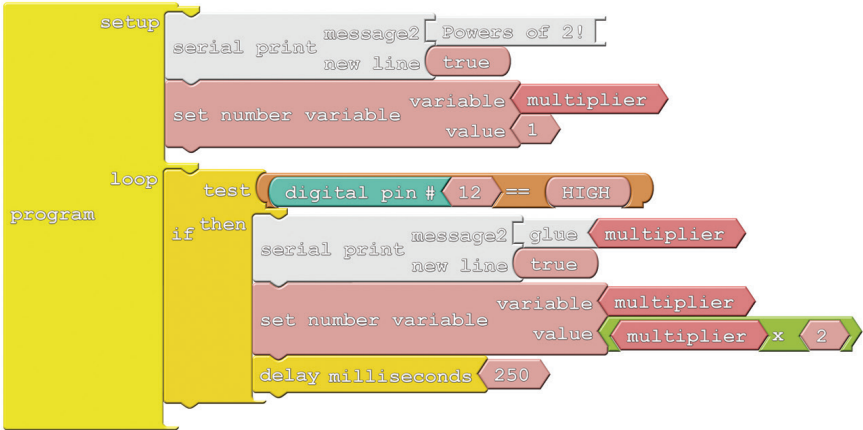

There are two new blocks this time, both of them shaded white and located under the communication bin:

- **Serial Print:** This block takes two parameters. At the top, place the **message** you want to print. You can put anything you want into the *message* block (even spaces!). If you want to add a variable or number, you'll need to add some glue. The bottom snap of *Serial Print* determines if a **new line** is printed after the message. Usually you'll want this to be set to *true*.
- **Glue:** *Glue* blocks allow you to **print values** like variables or numbers – anything that isn't a message you've written in. If you want to print a variable, you'll need to add a *Glue* block between the variable and the *Serial Print* block. There are **three different kinds** of *Glue* blocks, each with a different snap shape on the right. This time we'll use the block with a wedge (<) termination.

Do This

At the very beginning of our sketch, we want to print a friendly message. How about a short description of what our calculator is going to do: “Powers of 2!” Then set up a variable we can do some math on, starting at 1.

In the *loop*, we only want to do math and print when the button is pressed. So, begin by adding an *If* block to check whether pin 12 is HIGH (button is pressed). If the button is pressed, we’ll do our math and print out the result. To print a variable, we need to *glue* it to the *Serial Print* block with a wedge-shaped glue piece. Make your drawing match the one above.

With that, **upload** the sketch to your Sandbox. Then, to view the serial prints, click on the **Serial Monitor** button up top.



You’ll see your message printed. Now press the D2 button to start calculating.



Further Explorations

- Something funny happens when the power of 2 gets past 16834, and then turns to -32768, and then turns to 0. This is because our variable has reached its maximum value and has, in a sense, gotten confused. Can you add an if statement to catch an out of bounds *multiplier* variable and reset it?
- Try some of the other mathematical operators. You’re probably familiar with +, -, ×, and ÷, but what does the % operator do?

10: DO THE ANALOG SLIDE

Digital inputs, like the button, only allow for two input values: HIGH or LOW. But what about the in-betweens? When you turn the volume up on your stereo, you're not forced to pick between mute and "OW MY EARS." For volume control and other "finely-tuned" settings, we need **analog inputs**.

Active Part

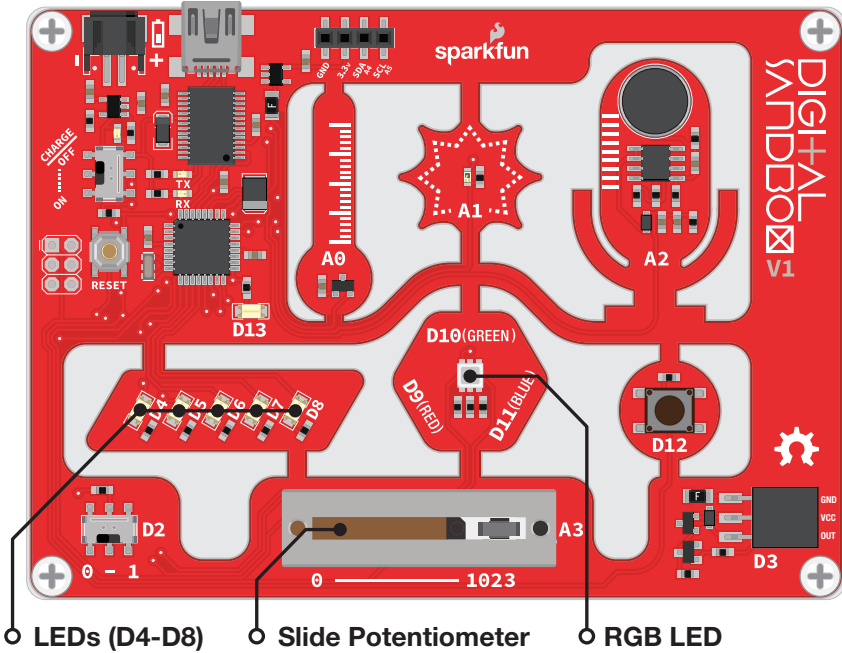

Background Information

Analog inputs are components that put data **into** a system with a range of more than two values. On the Digital Sandbox, analog inputs can produce a value anywhere between 0 and 1023 (1024 total values). The value produced by an analog input is proportional to the **voltage** it produces. If an analog component reads a value of 0, the voltage is 0V. If the output value is 1023, then the voltage is 5V. An analog reading of 512 is about 2.5V, and so on.

A special component inside the Sandbox's microcontroller called an **analog-to-digital converter (ADC)** is able to convert that range of input voltages to a discrete number. This is a special circuit that most pins on the Sandbox don't have. It's so special that the ADC pins are labeled with a **preceding "A."** The analog sensors on the board are labeled as "A0," "A1," "A2" and "A3."

Many electronic components produce analog output, the most common of which is a **potentiometer**. "Pots" come in a variety of shapes and sizes. Rotary pots are commonly used to adjust the volume on a stereo. **Slide potentiometers**, like that on the bottom of the Sandbox, are often seen adjusting sound levels on mixing boards.

Code Components

Whew, after that last experiment it's time for an easy drawing:

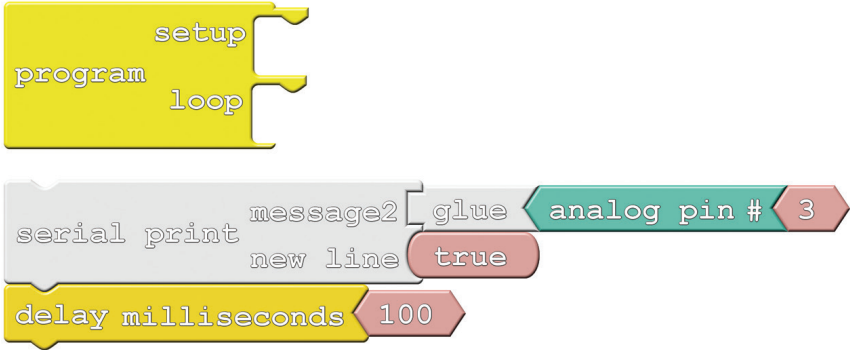

- **Analog Pin #:** Like the *Digital Pin* block, this block reads in the value of an input. But, instead of producing either true or false (1/0, HIGH/LOW), this block produces a number between 0 and 1024. The pink block snapped to the right of this one indicates which analog pin should be read.

Do This

Snap the block group that starts with *Serial Print* into the *loop* section of *Program*, then **upload** and open the **serial monitor**.

Every 100ms an analog input value should be printed. Move the analog slider to adjust the value. Can you make the output 0? 1023? 512? Take note of which slide pot position relates to which value.

Further Explorations

- Can you make the slider control the LEDs? You could slide the white LEDs back and forth, or try controlling the brightness of the RGB LEDs with the slider.
- Why are there only 1024 output values? Why not an even 1000? (Hint: 2^{10})

11: AUTOMATIC NIGHT LIGHT

We now have all the programming tools we need to make some totally awesome, interactive projects. Let's incorporate the light sensor – another analog input component – to create an automatic night light that turns on when it's dark.

Active Parts

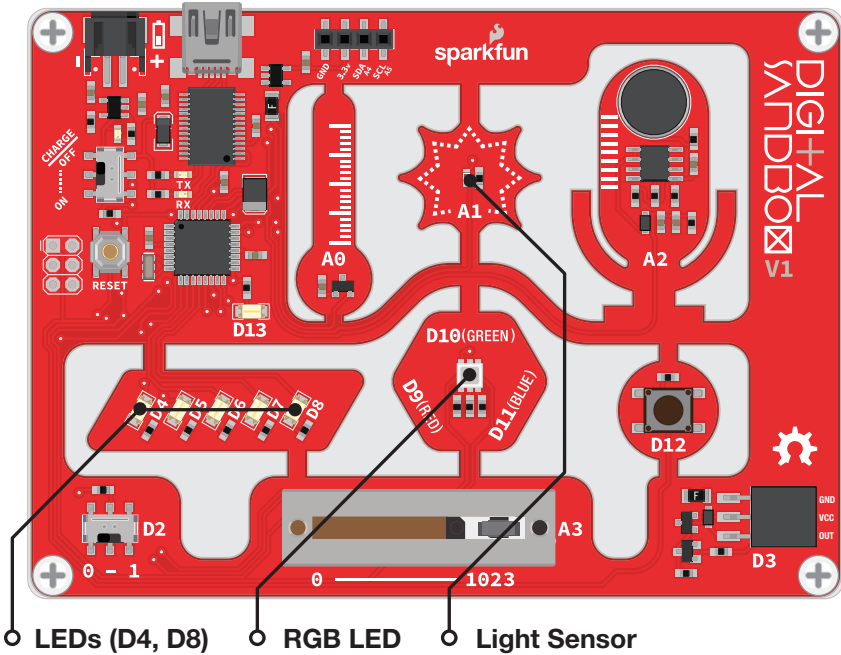

Background Information

You may not see them, but light sensors are incorporated into all sorts of modern electronic devices. There are light sensors in smartphones that measure how bright your environment is and adjust the screen brightness accordingly. There are light sensors in smoke detectors that detect particles in the air. Photogates use a light sensor to determine when an object passes a certain point – great for those photo finishes!

The light sensor on the Digital Sandbox is called a photo-transistor. It produces an analog voltage relative to the amount of light it sees. The lower the analog value, the darker the environment. If you cover the sensor completely, you might get the output all the way down to 0. Shine a flashlight on it and you might get a maximized reading of 1023.

Code Components

Here is the code block setup for this experiment:

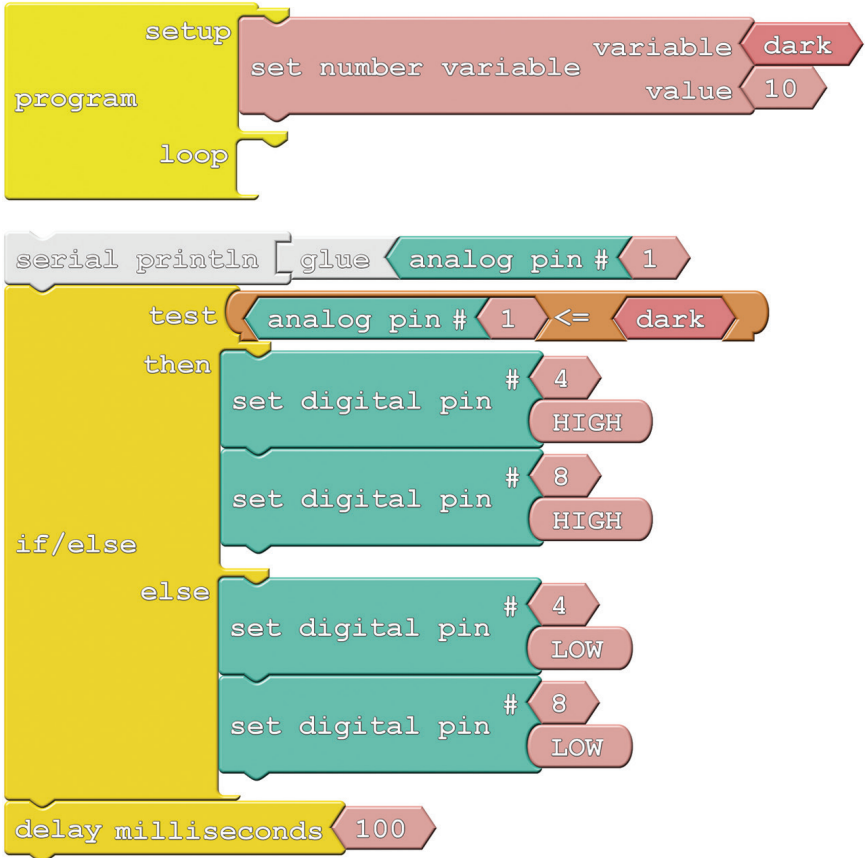

There aren't any new blocks, but we may have to adjust the value of the *dark* variable to make the night light work perfectly. That's where serial communication will come in handy!

Do This

Snap the block group that starts with *Serial PrintIn* into the *loop* section of *Program*. With that, **upload** the sketch to your Sandbox.

The trick to this experiment is finding the perfect setting for the *dark* variable. If your room is nice and bright, the white LEDs on pins 4 and 8 should be off. When the lights are off (or the sensor is covered), the LEDs should light up.

If the lights aren't behaving properly, that's OK! You just need to fine-tune the *dark* variable. Open up the serial monitor to view the output of the light sensor. Take note of the sensor's reading when the lights are on, then turn the lights off. What are the values now? Try setting the value of the *dark* variable just a bit higher than that.

Further Explorations

- If the brightness is right on the border of on/off, the LEDs can blink unpleasantly. Try adding another `if` statement to catch whether the light sensor is right in the middle range, then you can dim the LEDs based on what the sensor reads.
- Try incorporating the RGB LED into this project. If it's super-bright, make it light up yellow. Kind of dim? Green. Totally dark? Blue.

12: THERMAL ALERT!

“Is it hot in here, or is it just me?” Using a temperature sensor, which is able to precisely measure the room temperature, we can answer that question once and for all!

Active Parts

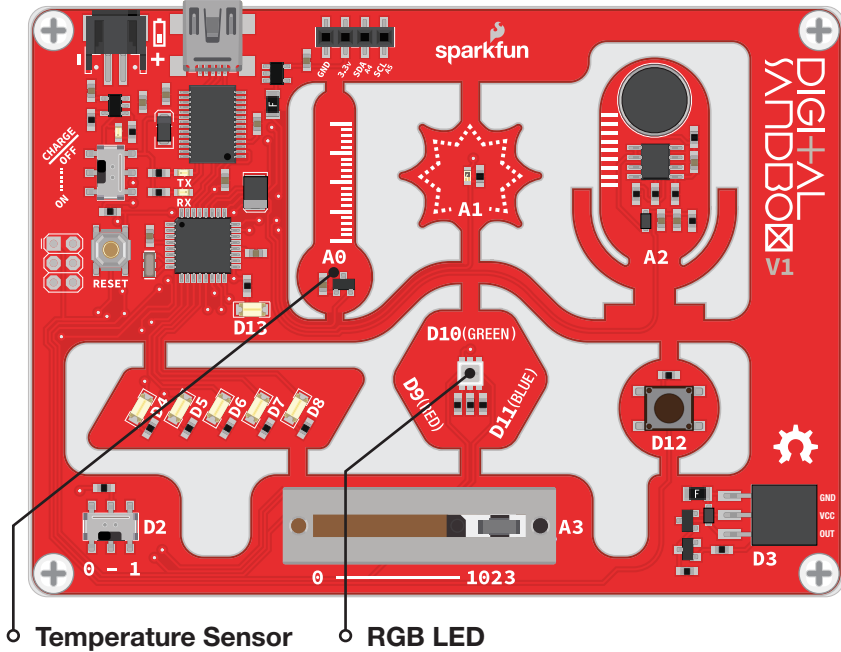

Temperature Sensor

RGB LED

Background Information

Temperature sensors are a critical component in many circuits, whether you're controlling an A/C system or creating a safety mechanism for gas-powered appliances. Electronic temperature sensors come in many form-factors, from big thermocouples that can measure up to 1000°C, to that little black rectangle on the Digital Sandbox.

The temperature sensor on the Sandbox produces an analog voltage that represents the temperature around it. The voltage is actually linearly proportional to the *Celsius* temperature. If you know the output voltage of the sensor, you can calculate the temperature with this equation:

$$\text{temp} = (\text{voltage} - 0.5) \times 100$$

We can have the microcontroller do all of that math for us as long as we find the right **algorithm** – an equation or set of instructions that accomplish a specified task.

Please note: This experiment has a lot of blocks. Remember you can also open this experiment from the **Digital Sandbox Examples** folder, so you can get started faster or troubleshoot if needed.

Code Components

We warned you that there'd be a lot of math on this one; here's the setup:

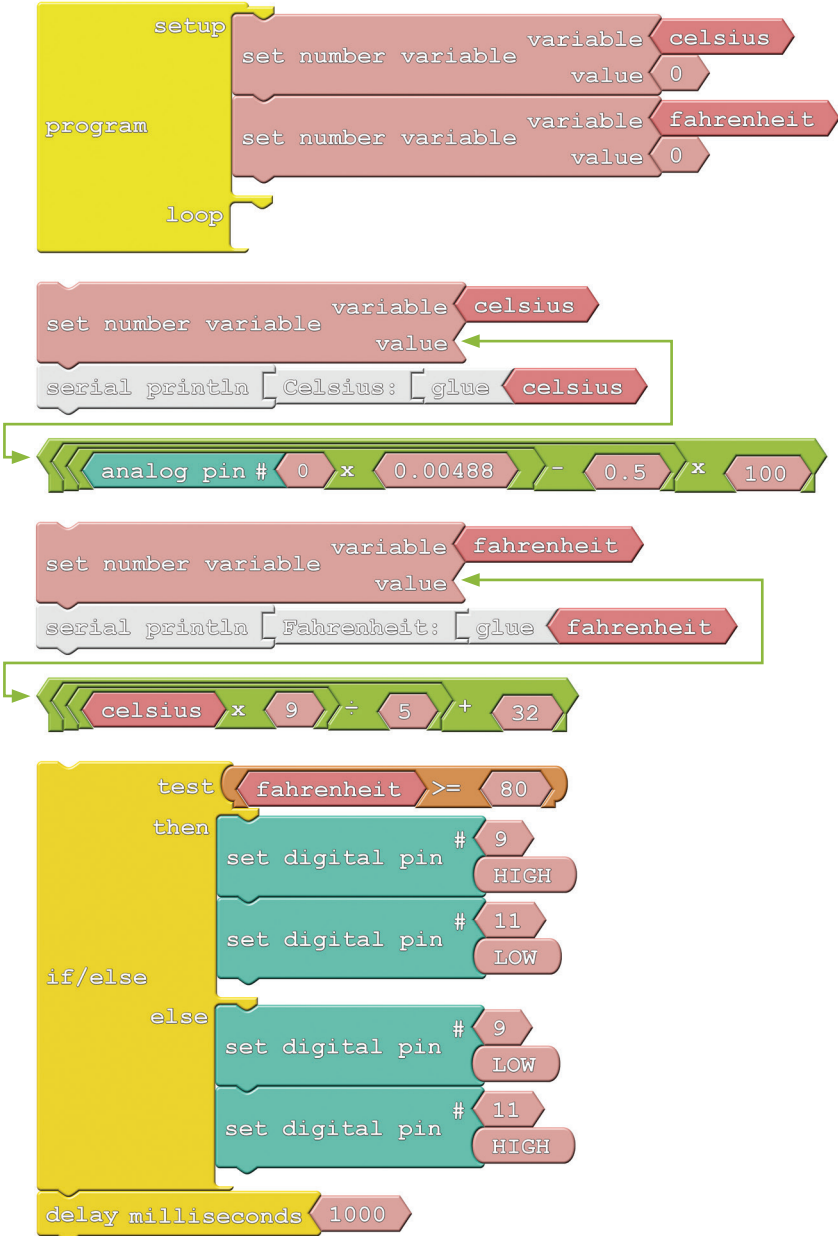

Experiment 12: Thermal Alert!

There aren't any new blocks here, but as you can see, we do get to use a wide variety of mathematical operators. Pay close attention to the **order of operations**. When you have a series of nested mathematical operators, the innermost operation is calculated first.

Do This

Construct the drawing as shown in the Code Component section. Make sure the mathematical operations are in the right order! Also important is the **decimal point** (e.g. “.0048,” and “.5”) on most of the numbers in these equations. Those tell the microprocessor that you want it to use extra precision when calculating.

There will be two different groups of **mathematical operator** blocks. Snap the right mathematical operator group block to the corresponding *Set Number Variable* block's *value*. Then, snap the two *Set Number Variable* block groups above the *If/Else* block group. You should have one big set of blocks that will go in the *Program* block's *loop*.

After you've completed the drawing, upload the sketch and check out the RGB LED. Is it red or blue? If it's red, you're probably plenty toasty, as your room temperature is above 78°F. If it's blue, try warming up the sensor by blowing on it. Can you get it to turn red?

To find the exact temperature reading, open up the **serial monitor**. After viewing the values here, you may want to alter the value of the *80* in the *if/else* test.

Further Explorations

- Can you add a third check to alert when it's too cold by turning on the blue LED? The real trick here is cooling the Sandbox off. One option is to power the board with a battery and stick it in the fridge.
- Celsius and Fahrenheit are two of the most common temperature scales, but they're not the only ones. Can you print the temperature in units of Kelvin or Rankine? You'll need to find an algorithm to convert to them from Celsius.

13: SOUND DETECTING

Introducing the amazing, groundbreaking SOUND (Sandbox's Over/Under Nominal Decibels) System! With the SOUND you'll always have an adjustable sound level detector handy.

Active Parts

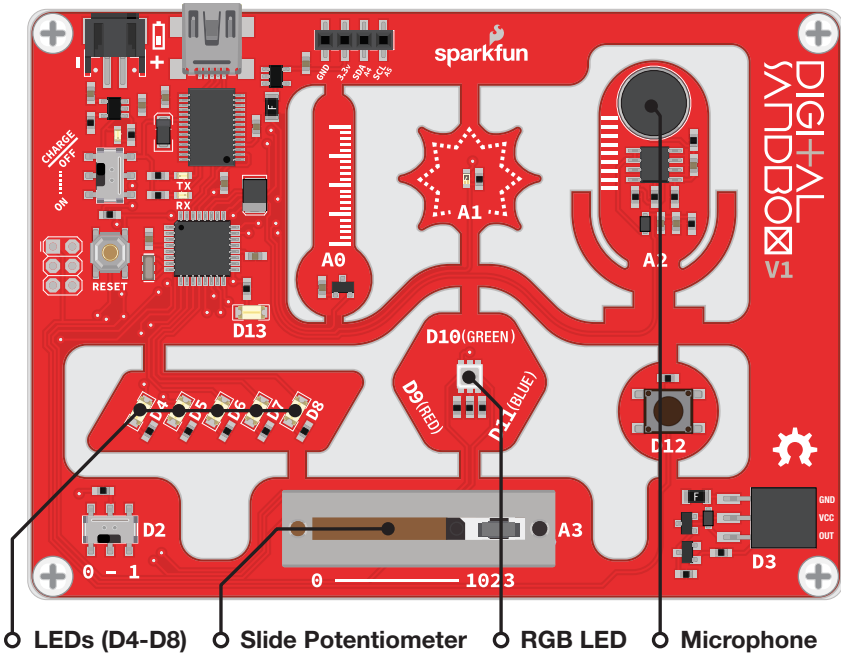

Background Information

In this experiment we'll use the Sandbox's on-board **microphone** to measure volume levels and display them on the LEDs. The microphone produces a sound wave which is just another analog voltage we can measure. The louder the sound, the higher the amplitude of the wave and the larger the voltage.

Without a lot of complicated math and filters, sound can be a difficult thing to measure and react to. Using the Sandbox for voice recognition isn't quite possible, but it can be programmed to pick out high volumes as long as it can sample the microphone input fast enough. We can use the slide potentiometer to set the sensitivity of the display.

Code Components

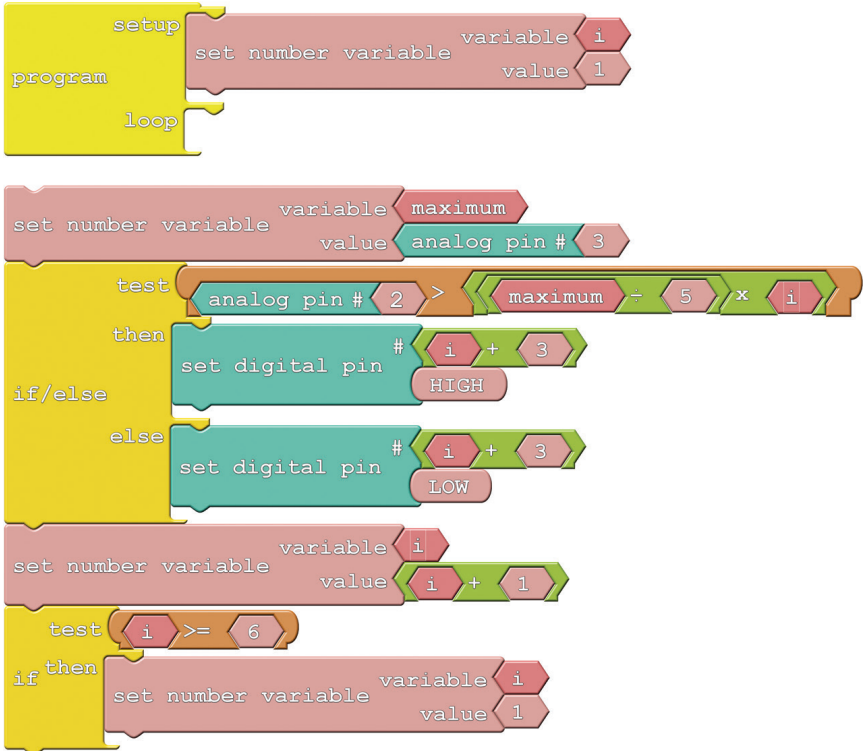

Do This

Snap the large block group starting with *Set Number Variable* block into the *loop* section of the *Program* block. After arranging the blocks, upload the sketch and have a look at the LEDs. Are they bouncing to your voice? If not, try **tapping on the mic**.

To adjust the **sensitivity** of the volume meter, move the slide pot up or down. With the slider set to the far right, it'll take a really loud sound to make every LED turn on. But if you set the slider too low even the slightest noise will set the meter off.

Further Explorations

- Can you rewrite the sketch to use the RGB LED instead of the white LEDs? Can you make it turn red when the volume is *really* loud and turn blue and/or green otherwise? Bonus points for using analog outputs!

14: OPTO-THEREMIN (ADD-ON)

In this experiment we'll attach a buzzer to the Sandbox and turn it into a musical instrument! By using the light sensor to control our buzzer's pitch, we can create a light-controlled **theremin** – a non-contact, electronic instrument.

This experiment is bonus material to be used with the **Digital Sandbox Add-on Kit**, which is sold separately.

Active Parts

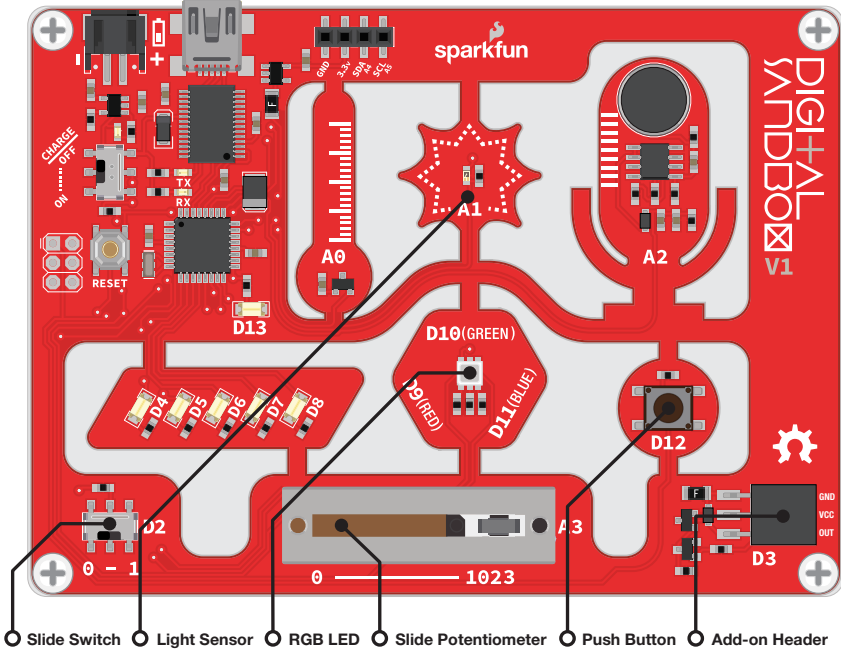

Background Information

By precisely modulating a pin, the Digital Sandbox can create electronic waves which, when routed through a **buzzer**, can produce a musical tone. We can program the Sandbox to control two characteristics of musical tone: pitch and duration.

A tone's **pitch** is what we perceive when we think of a note as being very high (screams, forks scratching plates, etc.) versus very low (like earth-rumbling bass). The pitch of a tone is very closely related to the **frequency** played through a buzzer. If we toggle a pin from HIGH to LOW then LOW to HIGH 440 times per second, for example, it produces a 440 Hz (hertz) frequency – a “middle A” pitch. Humans can hear frequencies ranging from 20 (low-pitch, bass) to 20,000 Hz (high-pitch, “ow, my ears”).

We can also program the **duration** of a tone – the length of time a pitch is played. In our program we'll use the delay function to set the duration. Playing a tone with the Sandbox is very easy. Just give it a pitch and it'll start toggling the output pin for you. Much like analog output, you can set it and forget it; the tone won't stop playing until you tell it to.

Code Components

This program introduces the **Tone** and **No Tone** block. Here's the full layout:

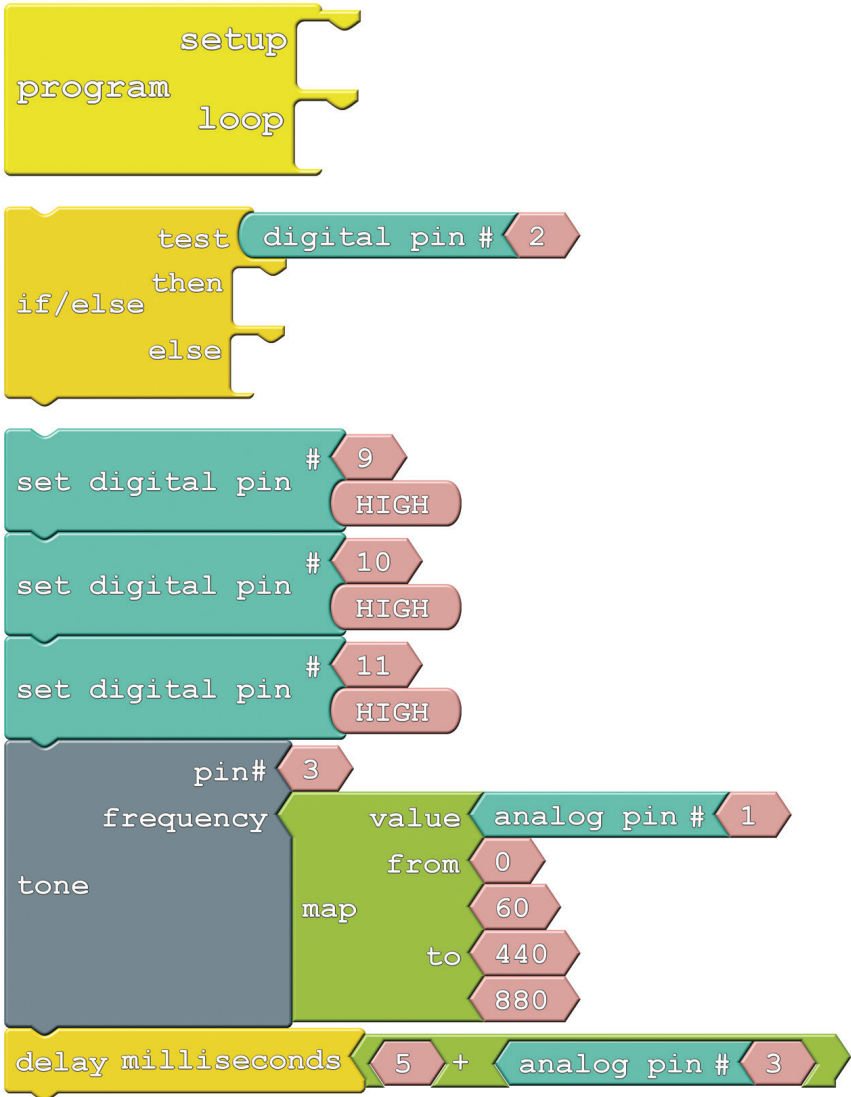

Experiment 14: Opto-Theremin (Add-on)

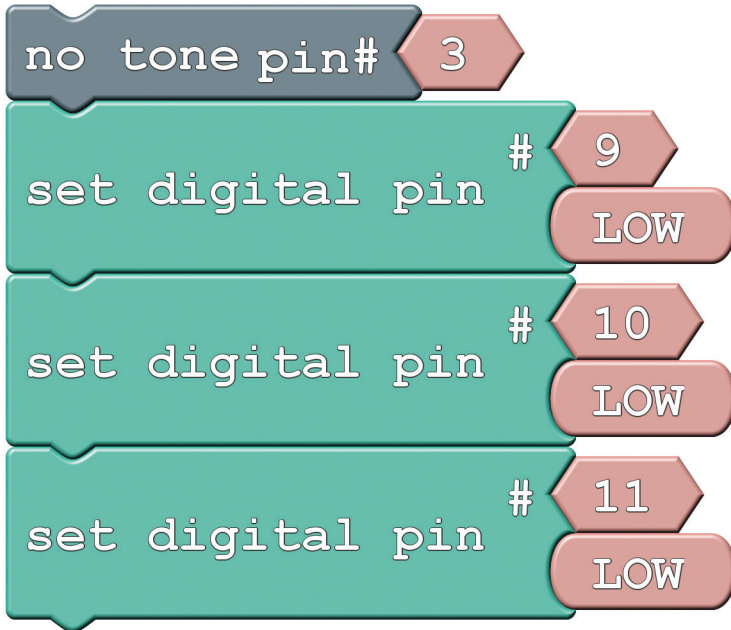

- **Tone:** This block takes two inputs: a pin number and a **frequency**. The pin number can be any digital pin, but in this case we'll use the expansion connector on pin 3. Frequency can be anything from 31 Hz to the extent of your audible range.

A tone initiated by the *Tone* block will go on and on until you call a *No Tone* block. *No Tone* simply halts a pin from playing a tone. Both of these blocks can be found under the **Utilities** bin.

- **Map:** This handy function maps a value from one range to another. In this experiment, we're taking a value (the output from A3) between 0 and 60, and mapping that to a range from 440 to 880. So an analog reading of 0 becomes 440, and a reading of 60 becomes 880; anything in between is relative to those two ranges. The map function can be especially useful in mapping an analog input (0-1023) to an output (0-255).

Do This

There are a lot of blocks in this experiment to snap together! First, snap the *If/Else* block in the *loop* of the *Program* block. Snap the *Set Digital Pin* **block group** in the **then** of the *If/Else* block. Snap the **block group** that starts with the *No Tone* block in the **else** of the *If/Else* block.

Experiment 14: Opto-Theremin (Add-on)

Whew, now upload to the Sandbox! You'll also need to connect the speaker to the expansion connector. Before you can do that, you will need to break off *one group* of **three pins** from the male breakaway headers. Now, you can connector the buzzer, with the **top side facing down**, to the expansion connector as shown in this image:

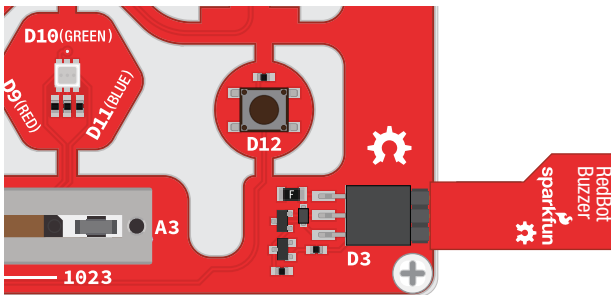
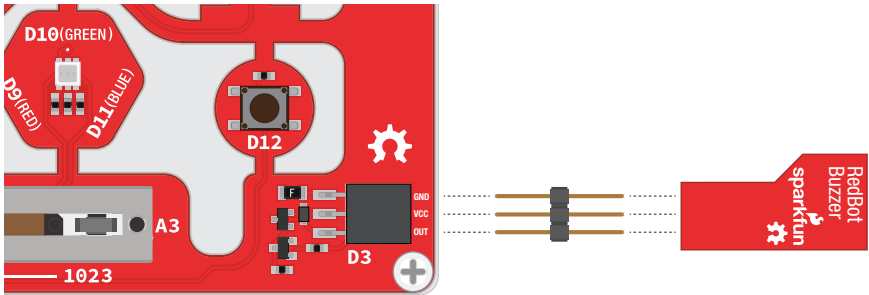

As fun as the opto-theremin may be, the sound is considered grating by some, so the code implements a simple ON/OFF function. Slide the **switch** over to the “1” position to turn the opto-theremin on.

Once the theremin is on, the speaker should start making noises. Try **covering the light sensor**; does the pitch change? We've turned the RGB LED white, so you can try to corral the light from that to control the light sensor.

You can adjust the duration of the tone by **sliding the potentiometer**. Slide the pot all the way to 0 to get a really fast, “zapper” sound, or slide to the right to create a soothing, slow song.

Further Explorations

- Try adding a “rest” function to your opto-theremin. Use the push button to intermittently cut off the sound output.
- Instead of using the Sandbox as a musical instrument, can you program it to play a written piece of music? Using a series of tones and delays, try reproducing the chorus of your favorite song!
- Give yourself a hearing test! What’s the highest frequency you can hear? Can you hear tones others can’t? Can your pet hear pitches that you can’t?

15: SERIAL MOTORING (ADD-ON)

Motors make the world go round. Well, not literally, but they make a lot things we use every day spin and actuate. There are tiny vibration motors in cell phones, speedy motors that spin CD and Blu-Ray discs, and of course, massive engine motors that help propel our cars. In this experiment we'll explore one of the most fundamental motor types out there: **DC motors**. And we'll tell the Sandbox precisely how fast we want the motor to spin.

This experiment is bonus material to be used with the **Digital Sandbox Add-on Kit**, which is sold separately.

Active Parts

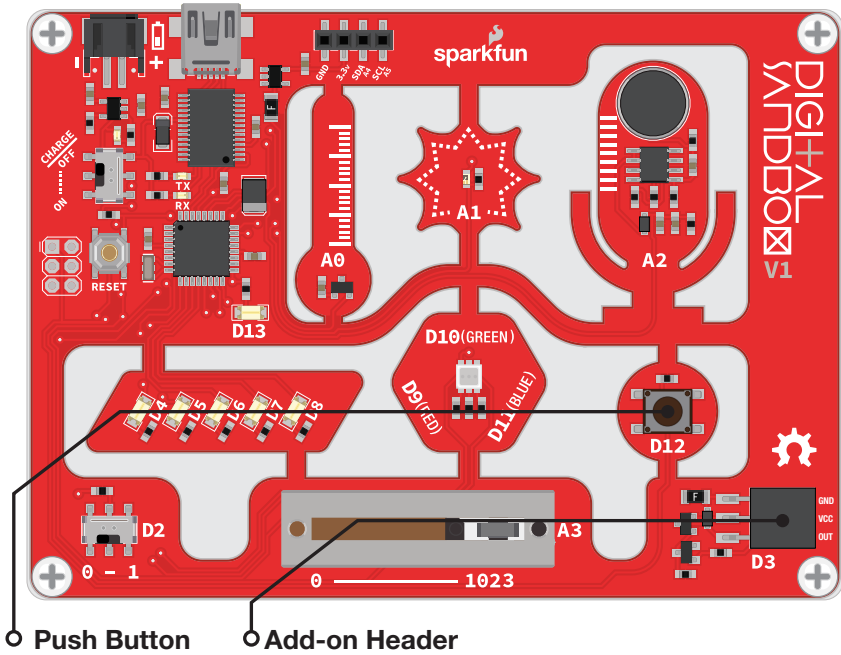

Background Information

A DC motor turns electrical energy into rotational, mechanical energy. DC motors are popular because they're very simple to control – give them some voltage and they spin. You can control the **speed** of a motor much as you might control the intensity of an LED – with PWM – so in this experiment, we'll be using the **analog output** block to control the motor's speed.

This experiment also introduces **serial input**. Up to this point our conversations with the Sandbox have been very one-sided – the Sandbox has been outputting data to the serial monitor. Serial input allows us to send data *to* the Sandbox via the serial monitor.

Please note: This experiment has a lot of blocks. Remember you can also open this experiment from the **Digital Sandbox Examples** folder, so you can get started faster or troubleshoot if needed.

Code Components

Here is the diagram for this program. The *Set Analog Pin* blocks are used to control the motor, and a *speed* variable is used to keep track of the motor speed. A few new blocks related to serial communication are introduced.

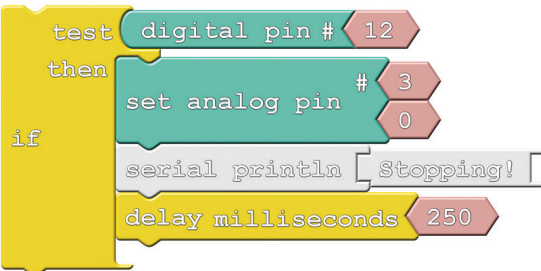
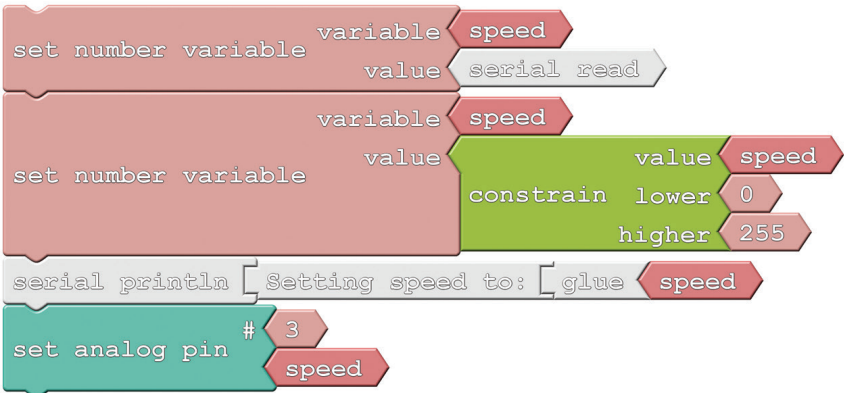
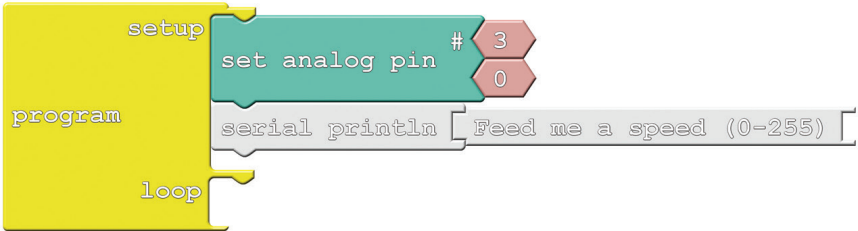

Experiment 15: Serial Motoring (Add-on)

- **Serial Read:** We'll use this block to put serial data *into* the Sandbox. The *Serial Read* block is like a number variable, but instead of using a *Set Number Variable* block to set it, we use the Serial Monitor. This block will store the integer most recently sent to the Sandbox from the Serial Monitor.
- **Data Available:** This block keeps track of whether or not any serial data is available. If no serial data has been sent to the Sandbox, this block stores a 0. If data is sent to the Sandbox this block will return a 1. The value of this block will go back to 0 once the serial data has been read (using the *Serial Read* block).

Do This

Snap the *Set Number Variable* block group into *then* in the **first If block group**. Next, snap the other *If* block group **below** the first *If block group*. You should now have a **block group** with two *If* blocks groups snapped together. Take that big **block group** and snap into the *loop* of the *Program* block. Now, you can upload the code!

After uploading, **connect the motor's black wire (GND)** to the **GND** pin on the Sandbox's add-on header. Then, connect the **motor's red wire** to the **OUT** pin on the Sandbox's add-on header. Your motor should now be connected to the Sandbox as shown in this picture:

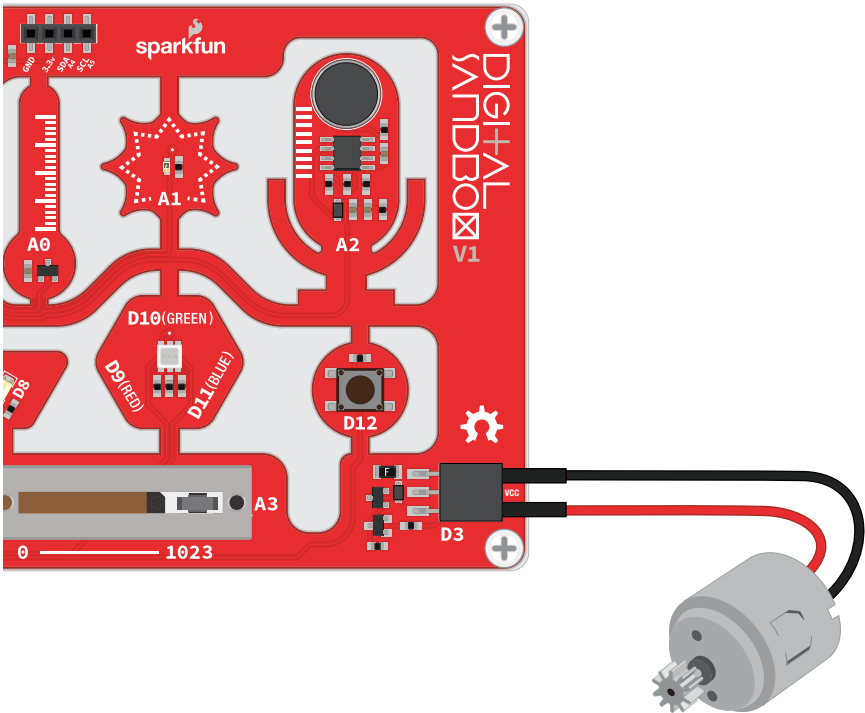

Experiment 15: Serial Motoring (Add-on)

Now open the **Serial Monitor**, type a number between 0 and 255 into the box next to “Send,” and then click that button. The Sandbox should respond with a message and the motor should start spinning.

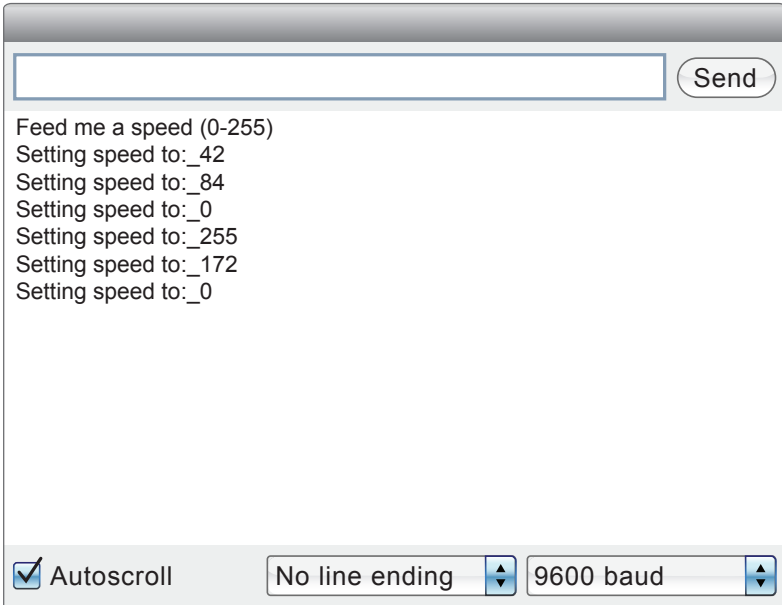

What happens when you send 255? How about 0? What happens when you send a number greater than 255 or less than 0 (a negative)? Can you spot a block in the code that is restricting those values?

As a “safety mechanism,” if you ever need to stop the motor from spinning, press the button to bring it to a halt.

Further Explorations

- Try connecting something mechanical to the motor. Perhaps tape a narrow piece of paper to create a spinner and play Twister. Or add a few pieces of paper to create a fan. What else can you connect to the axle to take advantage of the rotational motion?
- As a programming challenge, can you make the motor smoothly speed up or down when a new serial value is received?

16: SERVO SWEEPER (ADD-ON)

DC motors are great for spinning an object at high speed with no regard for where it starts or stops. For many applications, though, it's important to precisely control the **position** of a motor. Wing flaps in a plane, steering mechanisms in RC cars, and robotic arm platforms are applications that benefit from motorized position control. For those applications we ditch the DC motor and whip out the servo!

This experiment is bonus material to be used with the **Digital Sandbox Add-on Kit**, which is sold separately.

Active Parts

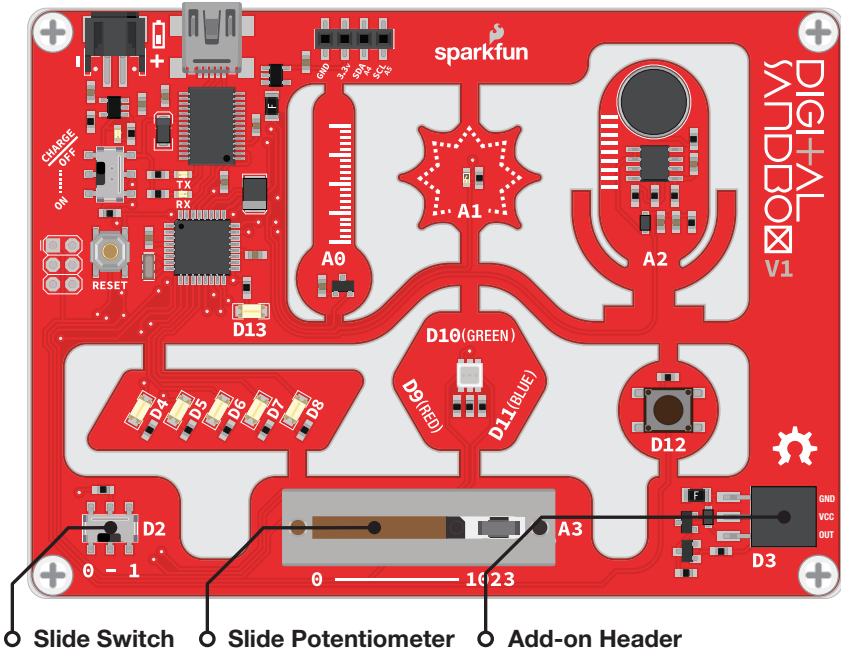

Background Information

A servo motor is like a DC motor with an internal controller and built-in sensors that help keep track of its shaft position. A servo motor knows, for example, if it's pointing at 15° or 115°.

Servos all have three wires that need connecting to: supply voltage, ground, and a signal. The voltage and ground connections supply the motor with power, and the control signal – a **PWM** output (surprise, surprise) – sets the position of the motor. Once the motor reaches the desired position, it stops until it is commanded to move to a new position.

Servo motors vary in their **range of motion** – the minimum and maximum angles they can point to. Only specialized, continuous rotation servos can rotate a full 360°; most have a stated range of motion between 90° and 180°. The servo we'll be using in this experiment has a 180° range of motion.

Code Components

This experiment introduces the *Servo* block. Here is the layout:

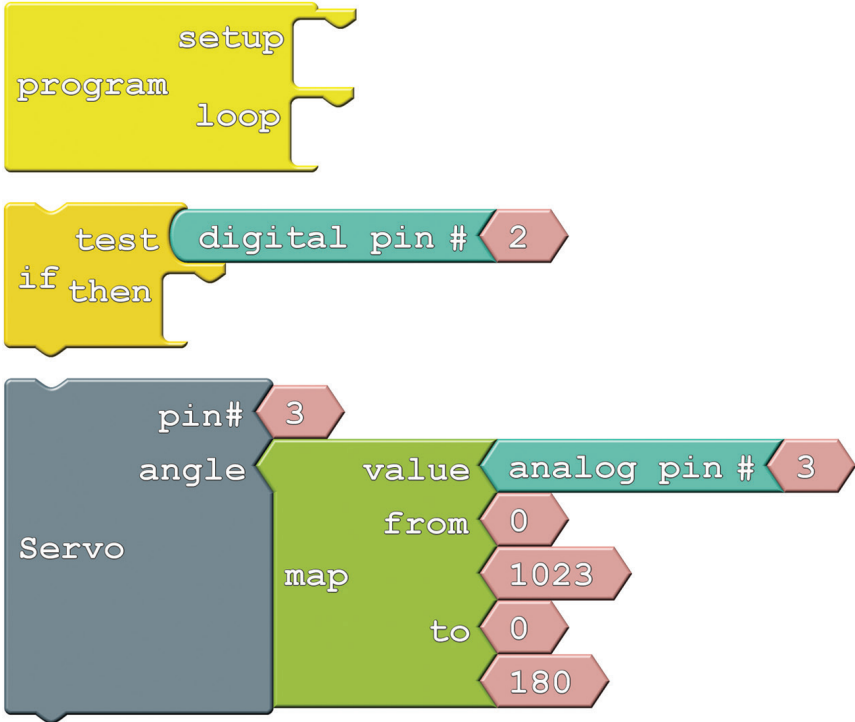

- Servo**: This block, found under the **Utilities** bin, allows you to move a servo to a set position. There are two inputs to supply to the Servo block: pin number and angle. Servos can be connected to any pin; we'll use the multi-purpose pin 3 in this example. The **angle** should be a number between 0 and the maximum range of your servo. In this case we'll constrain the range between 0 and 180 using the *Map* block.

Experiment 16: Servo Sweeper (Add-on)

Do This

Snap the **Servo block group** into the *then* of the *If* block. Next, snap the *If* block group into the *loop* of *Program* block. Upload it to the Sandbox.

After the code has been uploaded, connect the servo with the three pin male breakaway header to the Sandbox. Make sure the **servo's black wire** (GND) is lined up to the **GND** pin on the Sandbox, as shown here:

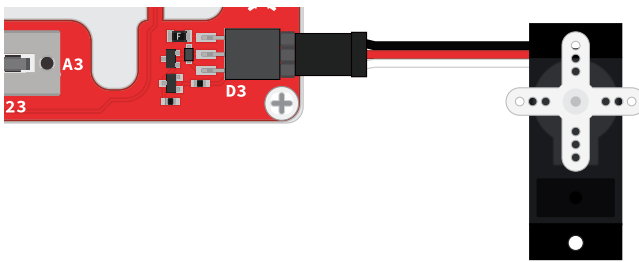
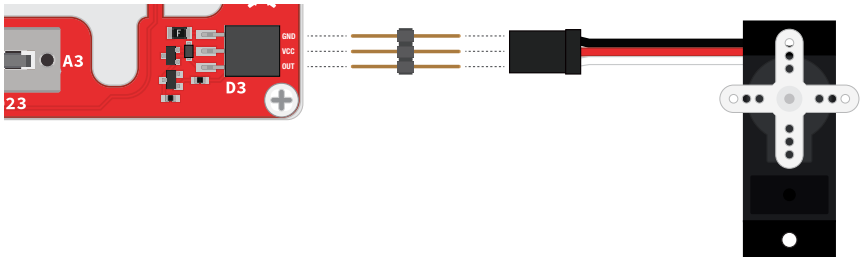

This program allows you to control the position of the servo motor with the sliding potentiometer. Slide all the way to the right to set the servo to 180°, and all the way to the left to set it to 0°.

The servo will only move if the switch (connected to pin 2) is set to ON. If you leave the switch in the ON position, you can see how fast the motor responds to the servo block. If you move the switch to OFF, set the position of the slide pot, and set the switch to ON, you can see the speed and control mechanisms of the motor.

Further Explorations

- What happens if you try to rotate the servo beyond 180° (change the last value in the map function)?
- Think of something to attach to the servo! You could add a clock hand to make a weird, half-circle clock. Or add a papercraft hand, and have your Sandbox give you a high-five!

Play and Learn!

Digital Sandbox helps to introduce the fundamental concepts of programming and electronics. Using ArduBlock – a simple, graphical version of the popular Arduino programming language – you will program 13 experiments that progressively explore subjects like digital inputs, analog outputs, serial communication and more.



The Digital Sandbox teaches programming; you will need a computer and an internet connection.



No soldering is required.

No previous experience necessary!

DIGITAL SANDBOX

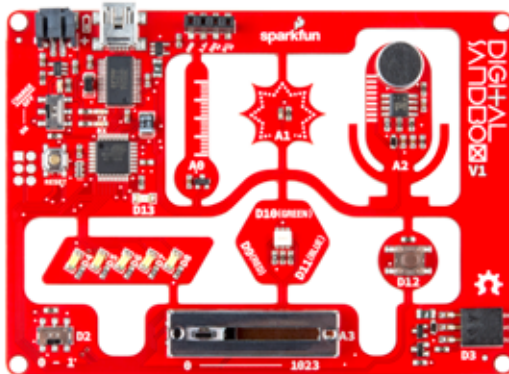

WHAT IS ON THE DIGITAL SANDBOX:

RGB LED	Temperature sensor	Microphone	USB connector
LEDs	Light sensor	Headers	ATmega328
Slide potentiometer	Push buttons	Slide switch	

WHAT IS INCLUDED IN KIT:

Digital Sandbox board	Baseplate	Standoffs
Instruction manual	Screws	USB cable

THE DIGITAL SANDBOX GUIDE HAS THREE BONUS ADD-ON EXPERIMENTS (ADD-ON PARTS NOT INCLUDED)

© SparkFun Electronics, inc. All rights reserved. The Digital Sandbox Kit features, specifications, system requirements and availability are subject to change without notice. All other trademarks contained herein are the property of their respective owners.

The Digital Sandbox Guide is licensed under the Creative Commons Attribution Share-Alike 3.0 Unported License.

To view a copy of this license visit: <http://creativecommons.org/by-sa/3.0/>

Or write: Creative Commons, 171 Second Street, Suite 300, San Francisco, CA 94105, USA.