

## AGF700-48S30

700 Watts

Full-brick Converter

**Total Power:** 700 Watts  
**Input Voltage:** 36 to 75 Vdc  
**# of Outputs:** Single

### Special Features

- Delivering up to 23.4A output
- Ultra-high efficiency 94.0% typ. at full load
- Wide input range: 36V ~ 75V
- Excellent thermal performance
- No minimum load requirement
- Fixed frequency operation
- RoHS 6 compliant
- Remote control function
- Remote output sense
- Trim function: 50% ~ 110%
- Input under voltage protection
- Output over current protection
- Output over voltage protection
- Over temperature protection
- Industry standard full-brick pin-out outline
- With aluminum baseplate
- Pin length optional

### Safety

IEC/EN/UL 60950  
CE Mark  
UL/TUV  
GB4943  
EN55022 Class B



### Product Descriptions

The AGF700-48S30 series is a single output DC-DC converter with standard full-brick outline and pin configuration. It delivers up to 23.4A output current with 30V output voltage. Above 94.0% ultra-high efficiency and excellent thermal performance make it an ideal choice to supply power to power amplifier in telecom RF application. Aluminum baseplate structure makes it possible for the module to work under -40 °C ~ +85 °C without air cooling.

### Applications

Telecom/ Datacom

## Model Numbers

Standard	Output Voltage	Structure	Pin length	RoHS Status
AGF700-48S30LT	30Vdc	Baseplate	5.8mm	R6

## Ordering information

AGF700	-	48	S	30	-	6	L	T
①		②	③	④		⑤	⑥	⑦

①	Model series	AGF: high efficiency full-brick series; 700: output power 700W
②	Input voltage	48: 36V ~ 75V input range, rated input voltage 48V
③	Output channel	S: single output
④	Rated output voltage	30: 30V output
⑤	Pin length	6: 3.8mm; Default:5.8mm
⑥	RoHS status	L: RoHS, R6
⑦	Mounting Hole	T: through hole

## Options

None

## Electrical Specifications

### Absolute Maximum Ratings

Stress in excess of those listed in the “Absolute Maximum Ratings” may cause permanent damage to the power supply. These are stress ratings only and functional operation of the unit is not implied at these or any other conditions above those given in the operational sections of this TRN. Exposure to any absolute maximum rated condition for extended periods may adversely affect the power supply’s reliability.

Table 1. Absolute Maximum Ratings:

Parameter	Model	Symbol	Min	Typ	Max	Unit
Input Voltage	Operating -Continuous	$V_{IN,DC}$	-	-	80	Vdc
	Non-operating -100mS		-	-	100	Vdc
Maximum Output Power	All	$P_{O,max}$	-	-	700	W
Isolation Voltage <sup>1</sup>	Input to outputs	Open frame module	-	-	1500	Vdc
	Input to baseplate	Baseplate module	-	-	1500	Vdc
	Outputs to baseplate	Baseplate module	-	-	500	Vdc
Ambient Operating Temperature	All	$T_A$	-40	-	+85	°C
Storage Temperature	All	$T_{STG}$	-55	-	+125	°C
Humidity (non-condensing)	Operating	All	-	-	95	%
	Non-operating	All	-	-	95	%

Note 1 - 1mA for 5s, Pollution degree 2

## Input Specifications

Table 2. Input Specifications:

Parameter	Conditions <sup>1</sup>	Symbol	Min	Typ	Max	Unit
Operating Input Voltage, DC	All	$V_{IN,DC}$	36	48	75	Vdc
Turn-on Voltage Threshold	$I_O = I_{O,max}$	$V_{IN,ON}$	31	35	36	Vdc
Turn-off Voltage Threshold	$I_O = I_{O,max}$	$V_{IN,OFF}$	30	33	35	Vdc
Lockout Voltage Hysteresis	$I_O = I_{O,max}$		1	1.5	3	V
Maximum Input Current ( $I_O = I_{O,max}$ )	$V_{IN,DC} = 36V_{DC}$	$I_{IN,max}$	-	-	23	A
No-load input current	$V_{IN,DC} = 48V_{DC}$		-	0.2	0.3	A
Standby input current	Remote OFF		-	0.02	0.1	A
Recommended Input Fuse	Fast blow external fuse recommended		-	30	-	A
Recommended External Input Capacitance	Low ESR capacitor recommended	$C_{IN}$	470	-	-	uF
Input filter component values(C\L)	Internal value			15\0.55		uF\uH
Input Reflected Ripple Current	Through 12uH inductor		-	50	160	mA
Operating Efficiency	$T_A=25\text{ }^\circ\text{C}$ $I_O = I_{O,max}$ $I_O = 50\%I_{O,max}$	$\eta$	-	94.0 94.5	-	% %

Note 1 -  $T_a = 25\text{ }^\circ\text{C}$ , airflow rate = 400 LFM,  $V_{in} = 48\text{Vdc}$ , nominal  $V_{out}$  unless otherwise noted.

## Output Specifications

Table 3. Output Specifications:

Parameter	Conditions <sup>1</sup>	Symbol	Min	Typ	Max	Unit	
Factory Set Voltage	$V_{IN,DC} = 48V_{DC}$ $I_O = I_{O,max}$	$V_O$	29.4	30	30.6	Vdc	
Output Voltage Line Regulation	All	$V_O$	-	0.05 15	0.2 60	% mV	
Output Voltage Load Regulation	All	$V_O$	-	0.2 60	0.5 150	% mV	
Output Voltage Temperature Regulation	All	$\%V_O$	-	-	0.02	$\%/^{\circ}C$	
Output voltage trim range	All	$V_O$	15	-	33	V	
Total Output Voltage Range	Over sample, line, load, temperature & life	$V_O$	29.1	30	30.9	V	
Output Ripple, pk-pk	Measure with a 1uF ceramic capacitor in parallel with a 10uF tantalum capacitor, 0 to 20MHz bandwidth	$V_O$	-	100	250	mV <sub>PK-PK</sub>	
Operating output current range	All	$I_O$	0	-	23.4	A	
Output DC current-limit inception <sup>2</sup>	All	$I_O$	25.2	-	33	A	
$V_O$ Load Capacitance <sup>3</sup>	All	$C_O$	470	1000	6800	uF	
$V_O$ Dynamic Response	Peak Deviation Settling Time <sup>4</sup>	25% load change 25% ~ 50% ~ 25% slew rate = 0.1A/us	$\pm V_O$	-	300	600	mV
		25% load change 50% ~ 75% ~ 50% slew rate = 0.1A/us	$T_s$	-	60	500	uSec
Turn-on transient	Rise time	$I_O = I_{max}$	$T_{rise}$	-	200	500	mS
	Turn-on delay time	$I_O = I_{max}$	$T_{turn-on}$	-	140	300	mS
	Output voltage overshoot	$I_O = 0$	$\%V_O$	-	-	5	%
Switching frequency	All	$f_{sw}$	260	290	320	KHz	
Remote ON/OFF control	All		1.5	-	5	mA	

Note 1 -  $T_a = 25^{\circ}C$ , airflow rate = 400 LFM,  $V_{in} = 48V_{dc}$ , nominal  $V_{out}$  unless otherwise noted.

Note 2 - Foldback first, then Hiccup. See Figure 10.

Note 3 - Out voltage can be start up when out external electrolytic Capacitor is 100uF/50V.

Note 4 - Recovery to within 1%  $V_{O,nom}$

## Output Specifications

Table 3. Output Specifications, con't:

Parameter	Conditions <sup>1</sup>	Symbol	Min	Typ	Max	Unit
Output over-voltage protection <sup>5</sup>	Over full temp range	V <sub>O</sub>	36	-	40	V
Output over-temperature protection <sup>6</sup> With baseplate	All	T	105	110	125	°C
Over-temperature hysteresis	All	T	5	-	-	°C
Output voltage remote sense range	Connecting S+ to the terminal of the load		-	-	0.3	V
MTBF	Telcordia SR-332-2006; 80% load, 300LFM, 40 °C T <sub>A</sub>		-	1.5	-	10 <sup>6</sup> h

Note 5 - Hiccup: auto-restart when over-voltage condition is removed.

Note 6 - Auto recovery.

## AGF700-48S30 Performance Curves

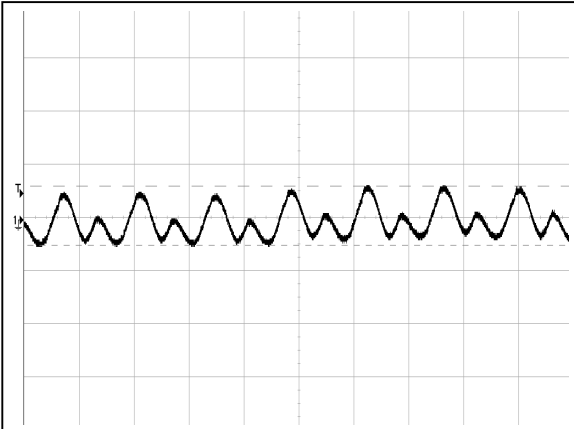

Figure 1: AGF700-48S30-6L Input Reflected Ripple Current Waveform  
Ch 1: I<sub>i</sub> (5 $\mu$ S/div, 20mA/div)

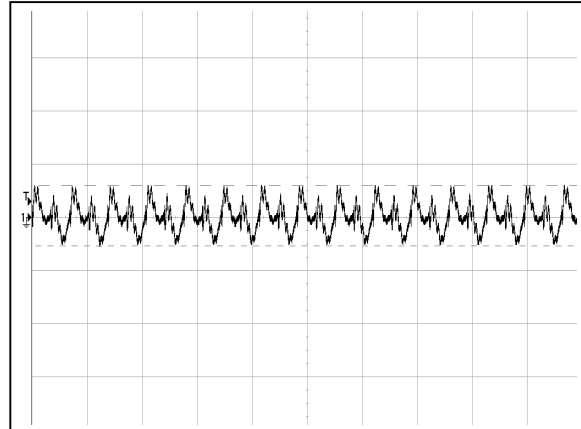

Figure 2: AGF700-48S30-6L Ripple and Noise Measurement  
Ch 1: V<sub>o</sub> (10 $\mu$ s/div, 100mV/div)

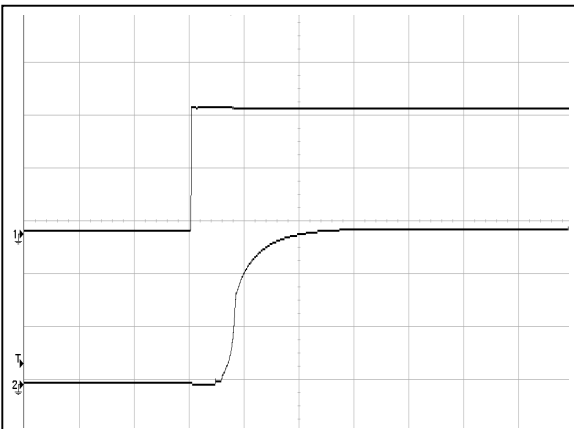

Figure 3: AGF700-48S30-6L Output Voltage Startup Characteristic (200mS/div)  
Ch 1: V<sub>in</sub> (20V/div) Ch 2: V<sub>o</sub> (10V/div)

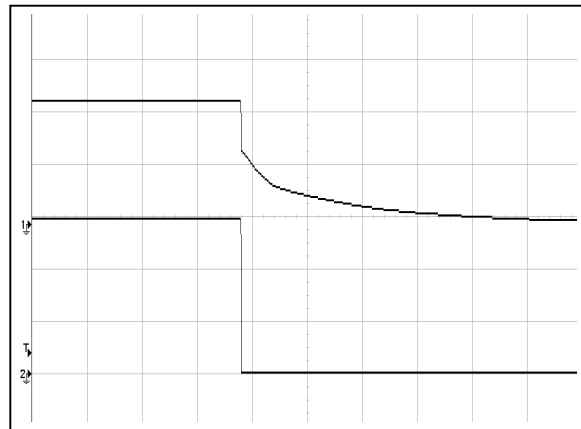

Figure 4: AGF700-48S30-6L Turn Off Characteristic (500mS/div)  
Ch 1: V<sub>in</sub> (20V/div) Ch 2: V<sub>o</sub> (10V/div)

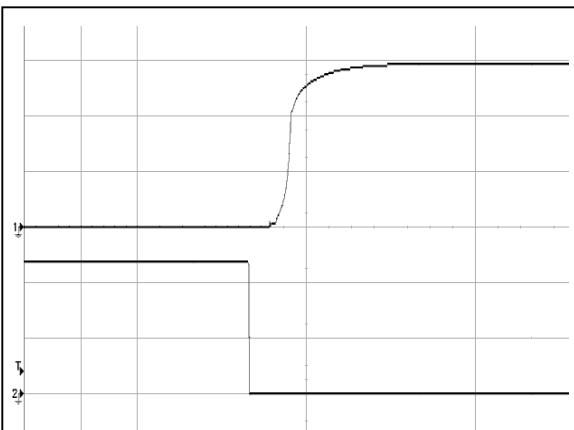

Figure 5: AGF700-48S30-6L Remote ON Waveform (200mS/div)  
Ch 1: V<sub>o</sub> (10V/div) Ch 2: Remote ON (20V/div)

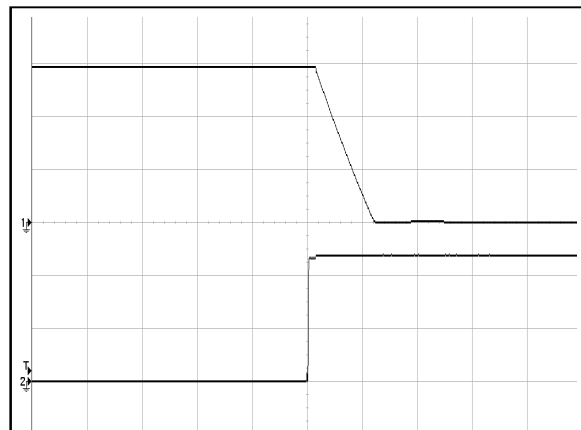
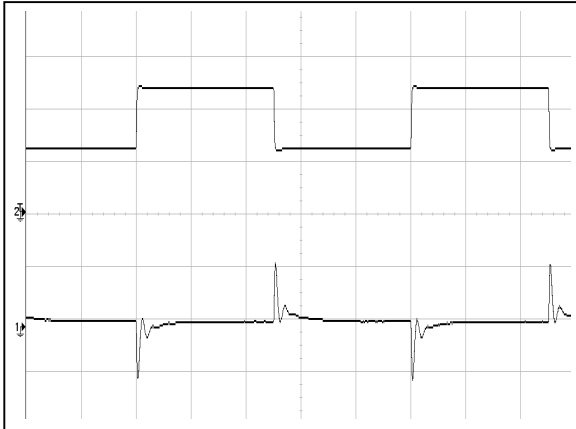
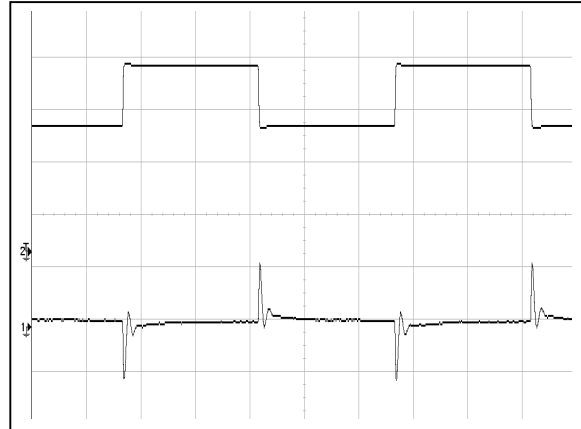

Figure 6: AGF700-48S30-6L Remote OFF Waveform (1mS/div)  
Ch1: V<sub>o</sub> (10V/div) Ch 2: Remote OFF (20V/div)

## AGF700-48S30 Performance Curves



**Figure 7: AGF700-48S30-6L Transient Response**  
 25%-50%-25% load change, 0.1A/uS slew rate,  
 Ch 1: Vo (200mV/div) Ch 2: Io (5A/div)



**Figure 8: AGF700-48S30-6L Transient Response**  
 50%-75%-50% load change, 0.1A/uS slew rate,  
 Ch 1: Vo (200mV/div) Ch 2: Io (5A/div)

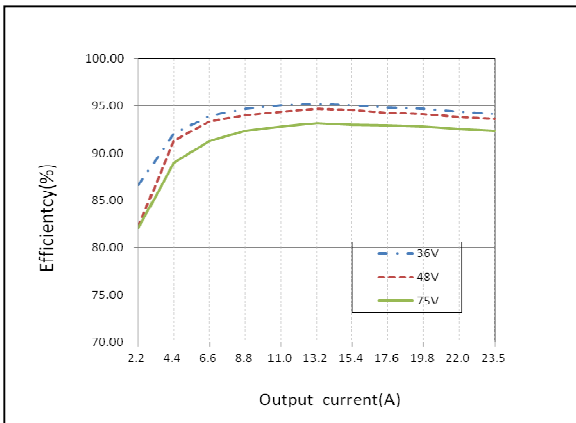

**Figure 9: AGF700-48S30-6L Efficiency Curves @ 25 °C**  
 Ta=25 °C, Tc=40 °C, Vo=30V

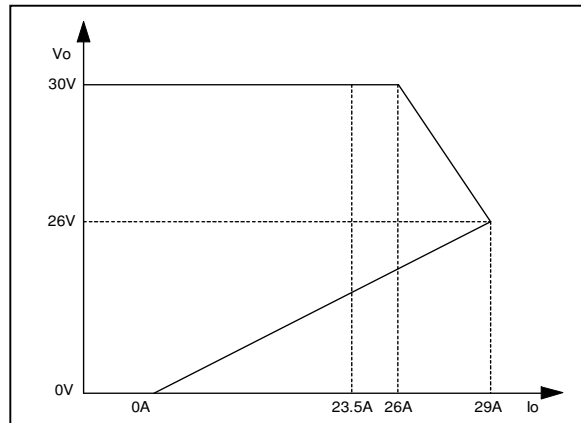

**Figure 10: Over-current protection characteristics<sup>1</sup>**

Note 1: It's only a sketch map of OCP action. Little alterations of the current value vs. voltage value are allowed.



# Mechanical Specifications

## Mechanical Outlines

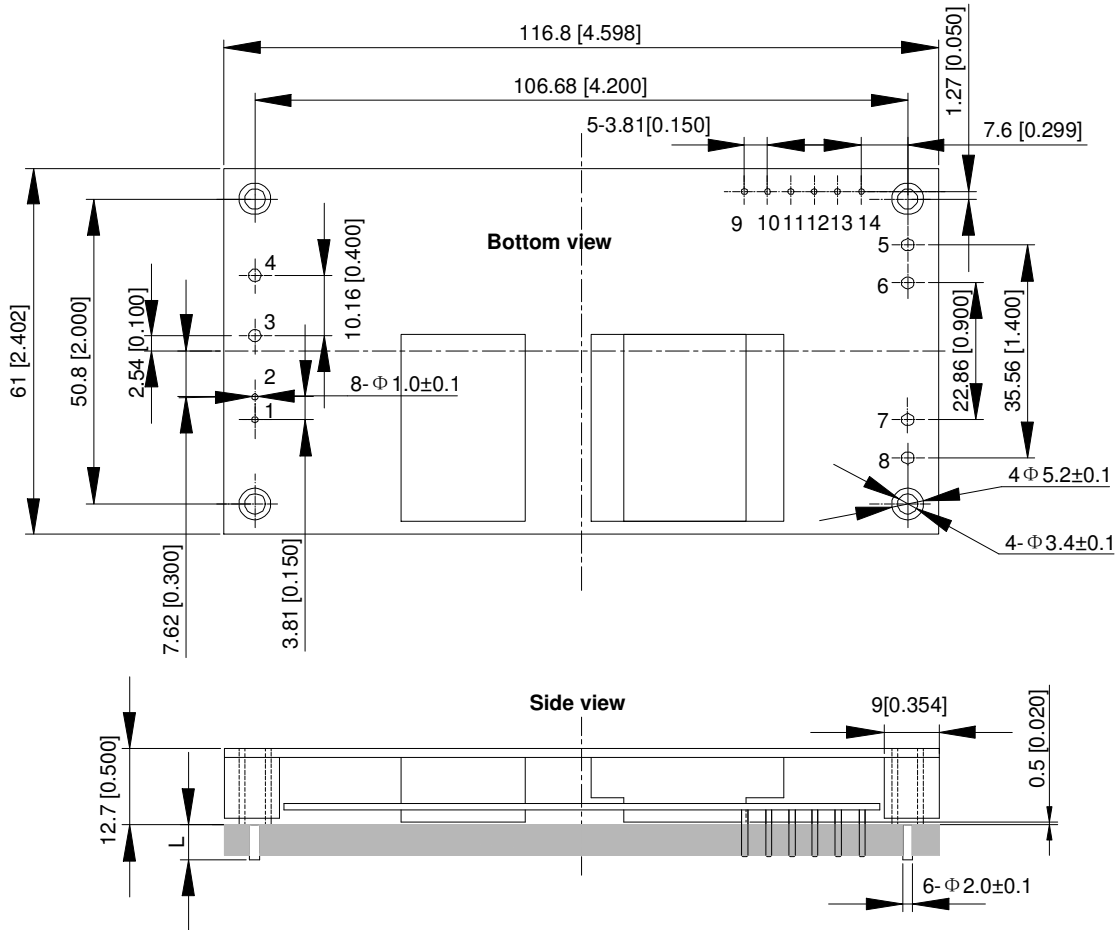

Unit: mm[inch]

Bottom view: pin on upside

Tolerance: X.Xmm±0.5mm[X.X in.±0.02in.]

X.XXmm±0.25mm[X.XX in.±0.01in.]

## Pin length option

Device code suffix	L
-4	4.8mm ± 0.5 mm
-6	3.8mm ± 0.5 mm
-8	2.8mm ± 0.5 mm
None	5.8mm ± 0.5 mm

## Pin Designations

Pin NO.	Name	Function
1	+On/Off	Remote control
2	-On/Off	Remote control return
3	V <sub>in+</sub>	Positive input voltage
4	V <sub>in-</sub>	Negative input voltage
5, 6	V <sub>o-</sub>	Negative output voltage
7, 8	V <sub>o+</sub>	Positive output voltage
9	AUX	Auxiliary voltage
10	IOG	Inverter operation good
11	NC	Not Connected
12	Trim	Trim terminal
13	+S	Positive Remote sensing
14	-S	Negative Remote sensing

## Environmental Specifications

### EMC Immunity

AGF700-48S30 series power supply is designed to meet the following EMC immunity specifications:

Table 4. Environmental Specifications:

Document	Description
EN55022, Class B Limits	Conducted and Radiated EMI Limits

### EMC Filter Configuration

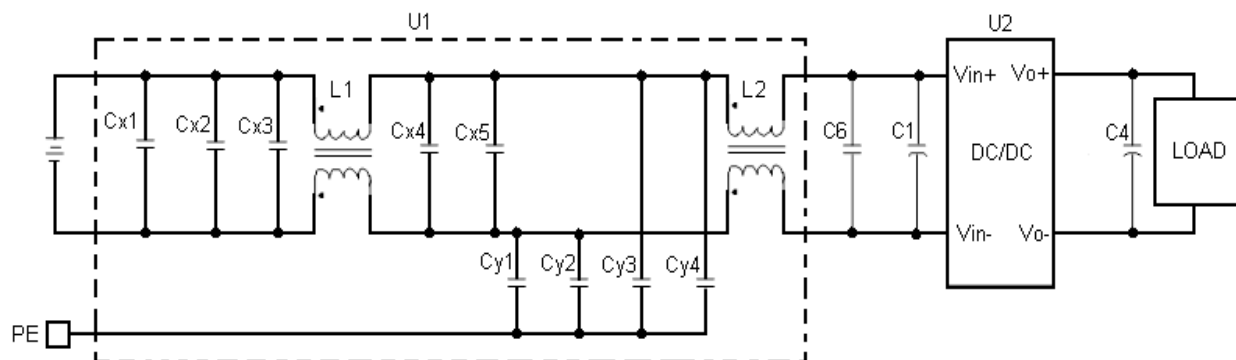

Figure 11 EMC test configuration

$C_{X1}, C_{X2}, C_{X3}, C_{X4}, C_{X5}$ : 1000nF/100V/X7R capacitor

$C_{Y1}, C_{Y2}, C_{Y3}, C_{Y4}$ : 0.1 $\mu$ F/1000V/X7R, Y capacitor

L1, L2: 473 $\mu$ H, common mode inductor

C6: 100nF/100V/X7R capacitor

C1, C4: See Figure 15

U1: 40A input EMC filter module

U2: Converter under test, AGF700-48S30

## **Safety Certifications**

The AGF700-48S30 series power supply is intended for inclusion in other equipment and the installer must ensure that it is in compliance with all the requirements of the end application. This product is only for inclusion by professional installers within other equipment and must not be operated as a stand alone product.

Table 6. Safety Certifications for AGF700-48S30 series power supply system

<b>Document</b>	<b>File #</b>	<b>Description</b>
UL 60950		US Requirements
EN60950		European Requirements
IEC60950		International Requirements
GB4943		China
CE		CE Marking

**Operating Temperature**

The AGF700-48S30 series power supplies will start and operate within stated specifications at an ambient temperature from -40 °C to 85 °C under all load conditions. The storage temperature is -55 °C to 125 °C.

**Thermal Considerations**

The converter can operate in an enclosed environment without forced air convection. Cooling of the converter is achieved mainly by conduction from the baseplate to a heatsink. The converter can deliver full output power at 85 °C ambient temperature provided the baseplate temperature is kept below the max values 100 °C .

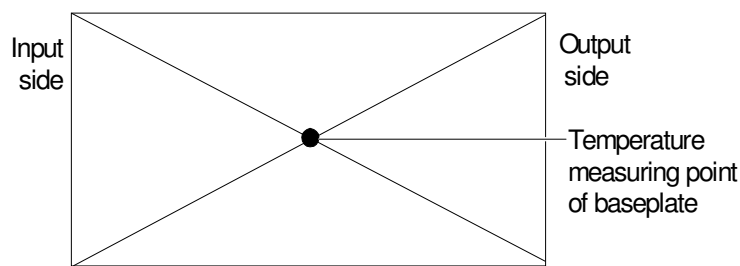

Figure 12 Temperature test point on baseplate

Table 7. Temperature limit of the test point

Test Point	Temperature Limit
Test point on baseplate	100 °C

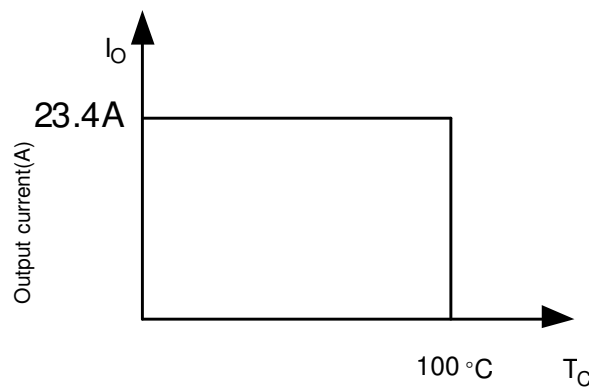

Figure 13 Output power derating curve, T<sub>c</sub>: temperature test point on baseplate, see Figure 12

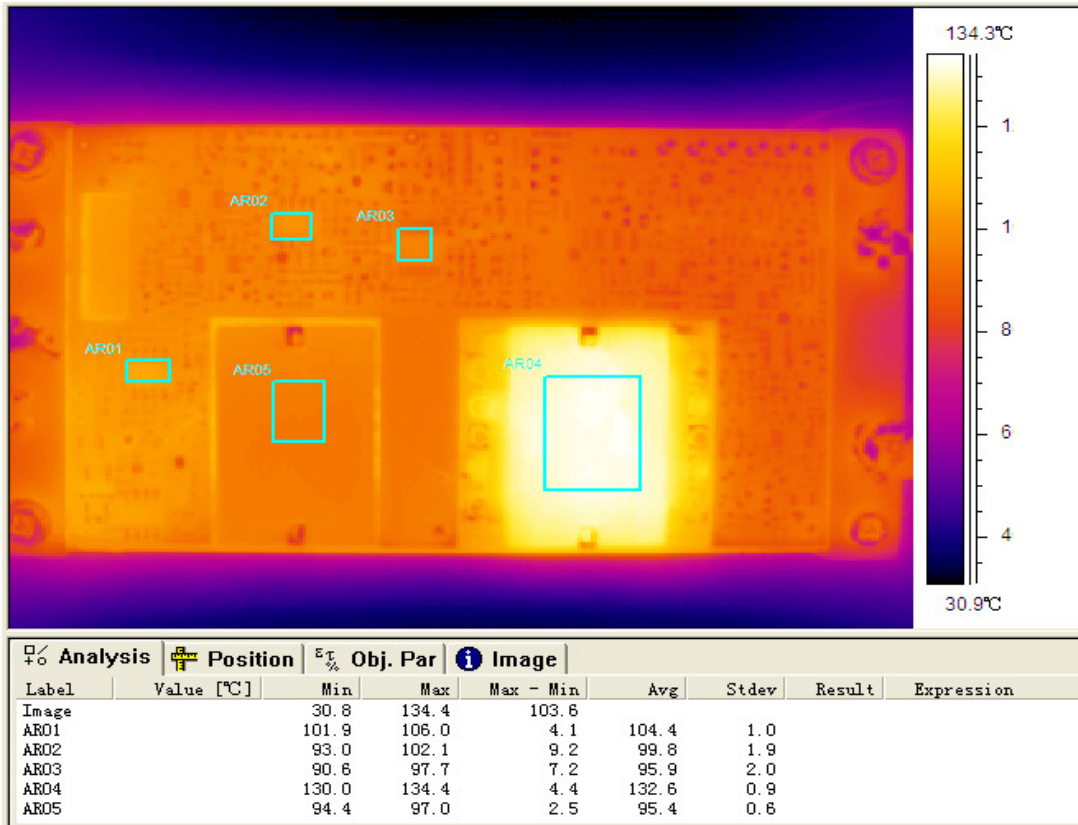

Figure 14 Thermal image, 48V<sub>in</sub>, 30V<sub>o</sub>, full load, room temperature

## Qualification Testing

Parameter	Unit (pcs)	Test condition
Halt test	4-5	$T_{a,min} - 10\text{ }^{\circ}\text{C}$ to $T_{a,max} + 10\text{ }^{\circ}\text{C}$ , $5\text{ }^{\circ}\text{C}$ step, $V_{in} = \text{min to max}$ , $0 \sim 105\%$ load
Vibration	3	Frequency range: $5\text{Hz} \sim 20\text{Hz}$ , $20\text{Hz} \sim 200\text{Hz}$ , A.S.D: $1.0\text{m}^2/\text{s}^3$ , $-3\text{db/oct}$ , axes of vibration: X/Y/Z. Time: 30min/axes
Mechanical Shock	3	30g, 6ms, 3axes, 6directions, 3time/direction
Thermal Shock	3	$-40\text{ }^{\circ}\text{C}$ to $100\text{ }^{\circ}\text{C}$ , unit temperature 20cycles
Thermal Cycling	3	$-40\text{ }^{\circ}\text{C}$ to $85\text{ }^{\circ}\text{C}$ , temperature change rate: $1\text{ }^{\circ}\text{C}/\text{min}$ , cycles: 2cycles
Humidity	3	$40\text{ }^{\circ}\text{C}$ , 95%RH, 48h
Solder Ability	15	IPC J-STD-002C-2007

## Application Notes

### Typical Application

Below is the typical application of the AGF700 series power supply.

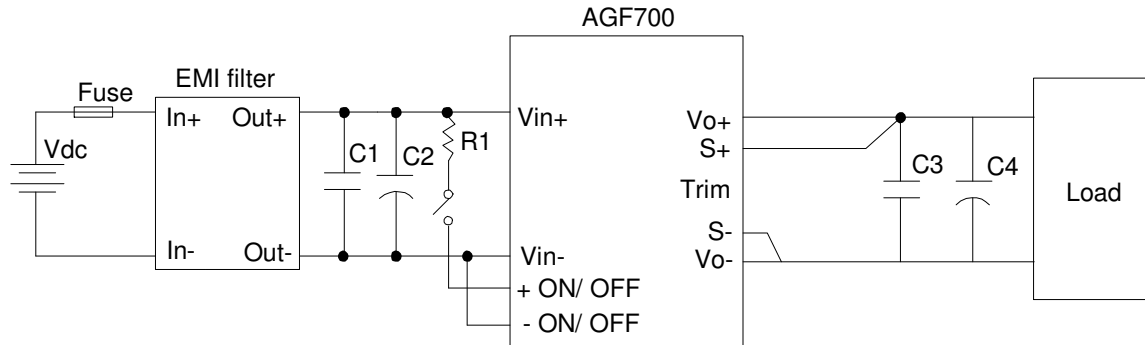

Figure 15 Typical application

R1: 20k $\Omega$  (1/2W), current limiting resistor

C1: 470 $\mu$ F/100V electrolytic capacitor, P/N: UPM2A471MHD (Nichicon) or equivalent caps.

C2, C3: 1 $\mu$ F/100V X7R ceramic capacitor, P/N: C3225X7R2A105KT0L0U(TDK) or equivalent caps

C4: 1000 $\mu$ F/50V electrolytic capacitor, P/N: UPM1H102MHD (Nichicon) or equivalent caps

External fast-acting fuse with a rating of 30A should be used in the application. The recommended fuse model is 0324030 or 314030 from LITTELFUSE.

### Sense Characteristics

If the load is far from the unit, connect +S to the terminal of the load to compensate the voltage drop on the transmission line. And -S should be always connected to Vo-. See Figure 15. If the sense compensation function is not necessary, short +S to Vo+ and -S to Vo- respectively.



## Remote ON/OFF

A remote ON/OFF control circuit is provided which is isolated from the input side, as well as, the output side. (Isolation withstand voltage: 1.5kVdc).

Connection of remote ON/OFF terminal is as follows. As shown in the figure below, output voltage turns remote ON when current is made to flow through remote ON/OFF terminal. Remote ON/OFF terminal can be controlled by opening or closing connections (with switch or relay).

Maximum source current for remote ON/OFF terminal is 5mA. Therefore, set current limiting resistor value such that this maximum source current value is not exceeded. Also, the allowable maximum reverse current flow is 5mA.

### Controlling the remote ON/OFF terminal from the input side

Connect current limiting resistor R1 is shown in the following figure .

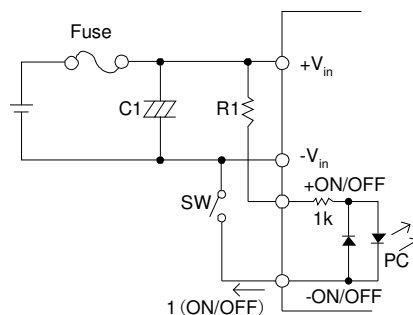

Figure 16 Connection of remote ON/OFF control (A)

R1: Recommended resistor value: 20kΩ (1/2W)

### Controlling the remote ON/OFF terminal from the output side

Connect the current limiting resistor R1 is shown in the following figure .

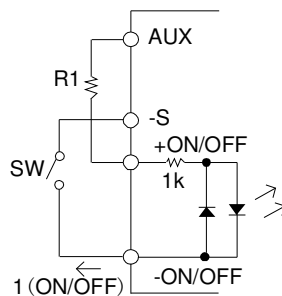

Figure 17 Connection of remote ON/OFF control (B)

R1: Recommended resistor value: 2kΩ (1/4W)

Note:

1. When wiring becomes long, connect a capacitor of about 0.1μF value between the +remote ON/OFF terminal and –remote ON/OFF terminal at a nearest distance.
2. Current limiting resistor can also be connected to the –remote ON/OFF terminal side.
3. The remote ON/OFF control mode is shown in the following table.

Remote ON/OFF level	Output status
Open (<100uA)	Remote OFF
1.5mA ≤ I (ON/OFF) ≤ 5mA	Remote ON

## Trim Characteristics

The output voltage of the converter can be trimmed using the trim pin provided. Applying a resistor between the trim pin and -S will cause the output to decrease. Applying a resistor between the +V<sub>o</sub> and +S will cause the output to increase. Trimming down more than 50% and trimming up more than 10% can cause the module to regulate improperly. If the trim pin is not needed, it should be left open.

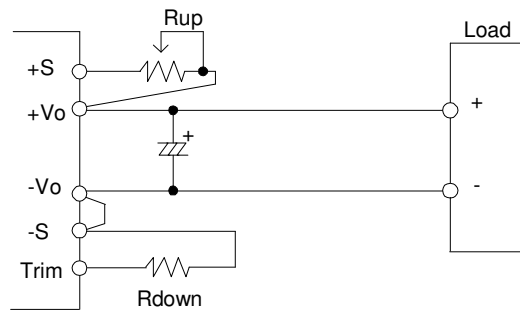

Figure 18 Trim circuit

$$R_{up} = 30 \left( \frac{V_o - V_e}{V_e} \right) k\Omega$$

$$R_{down} = -5.97 \left( \frac{V_o}{V_o - V_e} \right) k\Omega$$

V<sub>e</sub> is the rated output voltage and V<sub>o</sub> is the goal voltage.  
For example, to get 33V output, the resistor is:

$$R_{up} = 30 \left( \frac{33 - 30}{30} \right) k\Omega = 3k\Omega$$

For another example, to get 15V output, the resistor is:

$$R_{down} = -5.97 \left( \frac{15}{15 - 30} \right) k\Omega = 5.97k\Omega$$

Take note that when output voltage is increased, input voltage should be limited as shown in the following figure 19.

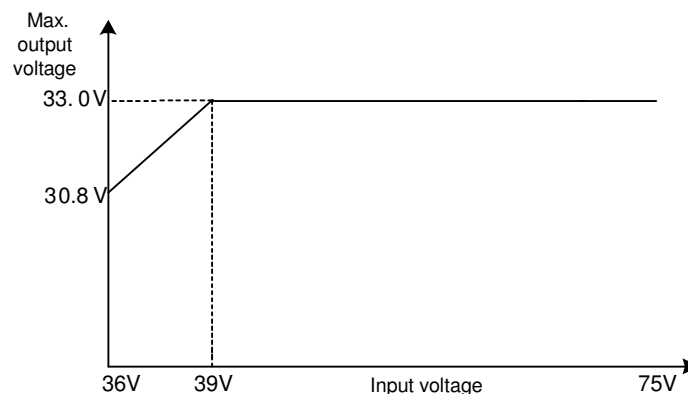

Figure 19 Trim-up-able voltage vs. input voltage

## Trim Characteristics

The output voltage can also be trimmed by potential applied at the Trim pin. An external resistor is needed between Trim pin and  $V_{trim}$ .

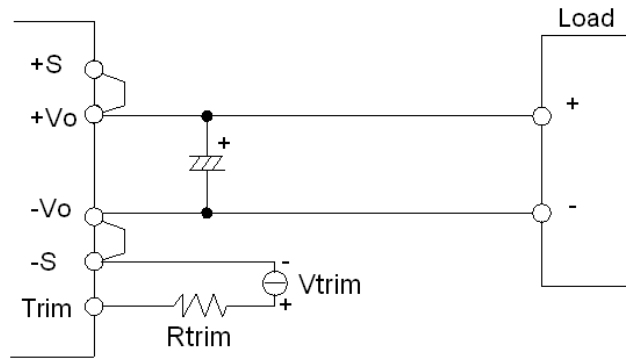

Figure 20 Trimmed by  $V_{trim}$  circuit

The equation of the trim voltage and output voltage is described as below,

$$V_{trim} = 1 + k\Delta\%$$

$$k = (R_{trim} + 5.97) / 5.97$$

$$\Delta\% = (V_o - V_e) / V_e \times 100\%$$

Where  $V_{trim}$  is the potential applied at the Trim pin, and  $V_o$  is the desired output voltage, and  $V_e$  is 30V,  $\Delta\%$  have a range of -50%~110%. The unit for  $R_{trim}$  is  $k\Omega$ .

When  $R_{trim} = 5.97k\Omega$

$$V_{trim} = V_o / 15 - 1$$

The corresponding relationship between  $V_{trim}$  and  $V_o$  is shown in Figure 21.

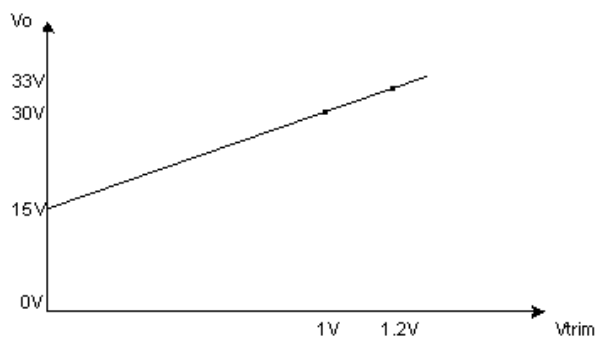

Figure 21  $V_{trim}$  voltage vs. output voltage ( $R_{trim} = 5.97k$ )

Considering the real resistor value,  $R_{trim} = 5.1k$  is recommended, the equation is shown as below.

$$V_{trim} = 0.062V_o - 0.854$$

The corresponding relationship between  $V_{trim}$  and  $V_o$  is shown in Figure 22.

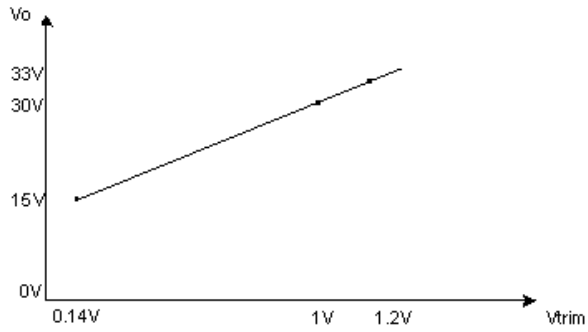

Figure 22  $V_{trim}$  voltage vs. output voltage ( $R_{trim}=5.1k\Omega$ )

## AUX

AUX is built in to operate the output side RC. If AUX is not used for RC, AUX can also be used for IOG signal output by opto-coupler. Output voltage value is within 7~10Vdc range, maximum output current is 20mA. Ground for the AUX terminal is -S terminal. AUX can be used for IOG signal output by opto-coupler.

\*Note: Avoid short circuit of AUX terminal with other terminals as this would lead to power module damage.

## IOG

IOG signal turns 'H' from 'L' within 1s when the output of the module is shut down. The specification of IOG is shown in the following table.

Item	IOG
Function	Normal operation 'L'
	Malfunction 'H'
Base pin	-Sense
Level voltage 'L'	0.5V max at 5mA
Level voltage 'H'	5V typ
Maximum sink current	5mA max
Maximum applicable voltage	35V max

There are two methods to use the IOG. The level from IOG can be used directly to monitor the operation of the module, as shown in Figure 23(A). An external power supply, which is no more than 35V, can also be used for IOG, and a current limiting resistor (R1) must be added to ensure the sink current less than 5mA, as shown in Figure 23(B).

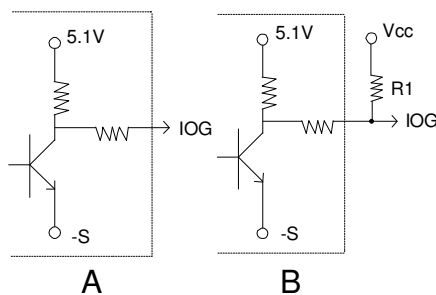

Figure 23 The application of IOG

**Input Ripple & Output Ripple & Noise Test Configuration**

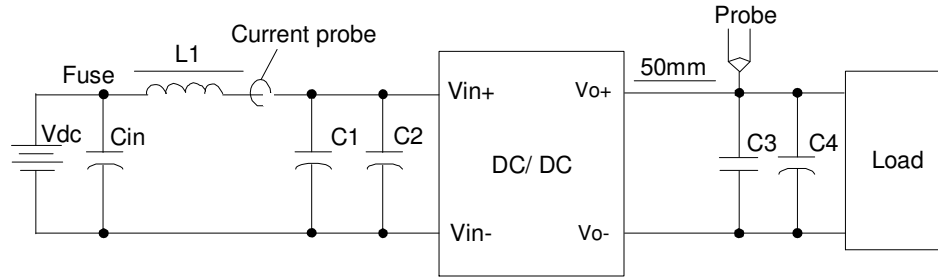

Figure 24 Input ripple & output ripple & noise test configuration

Vdc: DC power supply

L1: 12uH

Cin: 220uF/100V typical

C1 ~ C4: See Figure 15

Note - Using a coaxial cable with series 50ohm resistor and 0.68uF ceramic capacitor or a ground ring of probe to test output ripple & noise is recommended.

### **Weight**

The AGF700-48S30 series weight is 158g.maximum.

## Soldering

### √(R6 Wave Soldering)

The product is intended for standard manual or wave soldering.

When wave soldering is used, the temperature on pins is specified to maximum 255 °C for maximum 7s.

When soldering by hand, the iron temperature should be maintained at 300 °C ~ 380 °C and applied to the converter pins for less than 10s. Longer exposure can cause internal damage to the converter.

Cleaning of solder joint can be performed with cleaning solvent IPA or similitive.

	Product requirement	Remark	Product Name
R6	Wave soldering	30V	AGF700-48S30-6L
R6	Wave soldering	30V	AGF700-48S30LT



## Hazardous Substances Announcement (RoHS of China)

Parts	Hazardous Substances					
	Pb	Hg	Cd	Cr <sup>6+</sup>	PBB	PBDE
AGF700-48S30-6L	x	x	x	x	x	x
AGF700-48S30LT	x	x	x	x	x	x

x: Means the content of the hazardous substances in all the average quality materials of the part is within the limits specified in SJ/T-11363-2006

√: Means the content of the hazardous substances in at least one of the average quality materials of the part is outside the limits specified in SJ/T11363-2006

Artesyn Embedded Technologies has been committed to the design and manufacturing of environment-friendly products. It will reduce and eventually eliminate the hazardous substances in the products through unremitting efforts in research. However, limited by the current technical level, the following parts still contain hazardous substances due to the lack of reliable substitute or mature solution:

1. Solders (including high-temperature solder in parts) contain plumbum.
2. Glass of electric parts contains plumbum.
3. Copper alloy of pins contains plumbum

### WORLDWIDE OFFICES

#### Americas

2900 S.Diablo Way  
Tempe, AZ 85282  
USA  
+1 888 412 7832

#### Europe (UK)

Waterfront Business Park  
Merry Hill, Dudley  
West Midlands, DY5 1LX  
United Kingdom  
+44 (0) 1384 842 211

#### Asia (HK)

14/F, Lu Plaza  
2 Wing Yip Street  
Kwun Tong, Kowloon  
Hong Kong  
+852 2176 3333



[www.artesyn.com](http://www.artesyn.com)

While every precaution has been taken to ensure accuracy and completeness in this literature, Artesyn Embedded Technologies assumes no responsibility, and disclaims all liability for damages resulting from use of this information or for any errors or omissions. Artesyn Embedded Technologies, Artesyn and the Artesyn Embedded Technologies logo are trademarks and service marks of Artesyn Technologies, Inc. All other names and logos referred to are trade names, trademarks, or registered trademarks of their respective owners.  
© 2014 All rights reserved.

For more information: [www.artesyn.com/power](http://www.artesyn.com/power)  
For support: [productsupport.ep@artesyn.com](mailto:productsupport.ep@artesyn.com)