

NOT RECOMMENDED FOR NEW DESIGNS
PLEASE SEE [AN1775](#)

ISL59605-SPI-EVALZ Evaluation Board (with Serial Interface) Operation (Rev 1.0 to 4.0)

Description

The ISL59605-SPI-EVALZ board is designed to allow evaluation of the ISL5960x (MegaQ[™]) family of parts, as well as provide the reference schematic and PCB layout of a MegaQ[™] implementation on a 4-layer PCB. In addition to the MegaQ[™] equalization path, the board features a USB interface that allows access to and control of MegaQ[™] internal configuration registers, enabling a few more features than are available when using the stand-alone configuration (see the [ISL59605](#) datasheet for more details). *This Application Note is for revisions 1.0 to 4.0 of the ISL59605-SPI-EVALZ board. For revision 5.0 of the evaluation board, see [AN1775](#). The board revision number is found in the top right corner on the top side of the board.*

Initial Set-Up

This application note first describes how to set-up and use this evaluation board in a stand-alone configuration, then explains how to install the software and use the Windows GUI to read and write MegaQ[™] internal registers.

Power Connections

The power pins are located on the lower left of the evaluation board (see Figure 1). The board requires a 5V power supply capable of supplying at least 150mA. Because of the high amount of high-frequency gain required to equalize long cables, excessive noise on the power supply may introduce noise on the output signal or cause difficulty locking at longer distances.

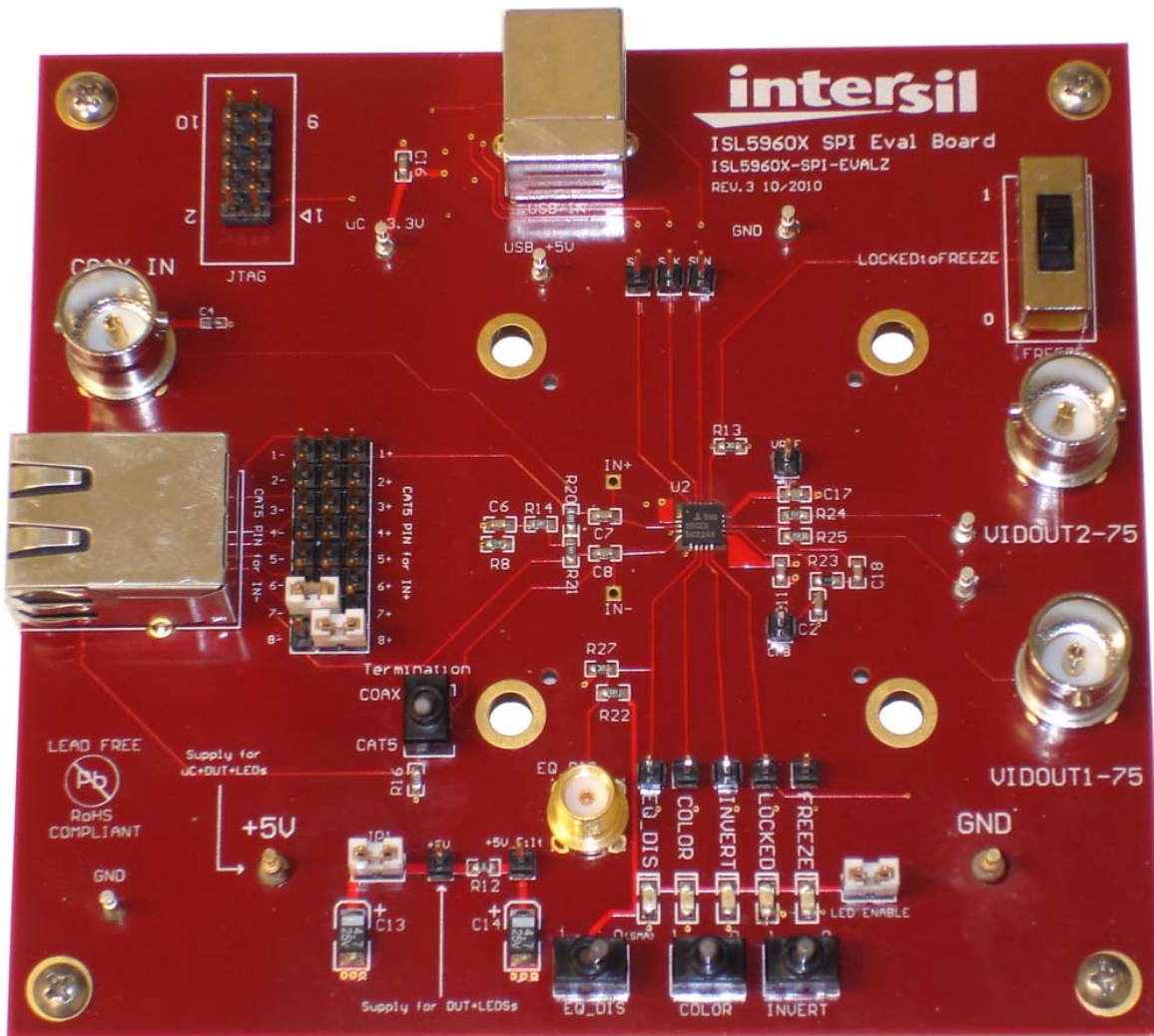

Application Note 1588

Power supplies with linear regulators are preferable to switching regulators, however, switching supplies may work acceptably well if they are adequately filtered.

Jumpers

There are several jumpers that need to be configured for proper operation of the evaluation board. JP1 is located just to the right of the +5V power connection. It needs to be in place for power to get to MegaQ™ and the LEDs. The jumper may be removed and replaced with an ammeter to measure the current consumed by MegaQ™ and (optionally) the LEDs. **JP1 must be shorted (either with a jumper or an ammeter) for the evaluation board to function!**

The LED Enable jumper selects whether the LEDs are grounded (i.e. will light-up when a MegaQ™ output goes high) or floating (will not light-up or consume current). To measure MegaQ™ current without the LEDs, remove the LED Enable jumper.

The large 3x8 header block is described in the next section.

The JTAG header on the upper left is used to program the microcontroller during production and is not used when operating the evaluation board. Do not connect anything to the JTAG header.

Input Connections

Unshielded twisted pair (UTP) signals arrive via the RJ-45 connector on the left. The input signal can arrive on any arbitrary combination of pins, though it should usually be one of the standard Cat x pairs of 1 and 2, 3 and 6, 4 and 5, or 7 and 8. The 3x8 header block to the right of the RJ-45 jack is used to assign which Cat x pin goes to the positive MegaQ™ input (in Figure 1, pin 8), and which goes to the negative input (pin 7). The “Termination” switch to the lower right of the jumper block should be switched to “CAT5” (as shown in Figure 1). Do not attach a coax cable while trying to receive a signal over Cat x.

Coax signals are connected through the “COAX IN” BNC connector on the upper left. When using coax signals, set the “Termination” switch to “COAX” and ensure that no Cat x cables are attached to the RJ45 connector.

The IN+ and IN- test points near U1 can be used to view the input signals at the input to the MegaQ™ chip.

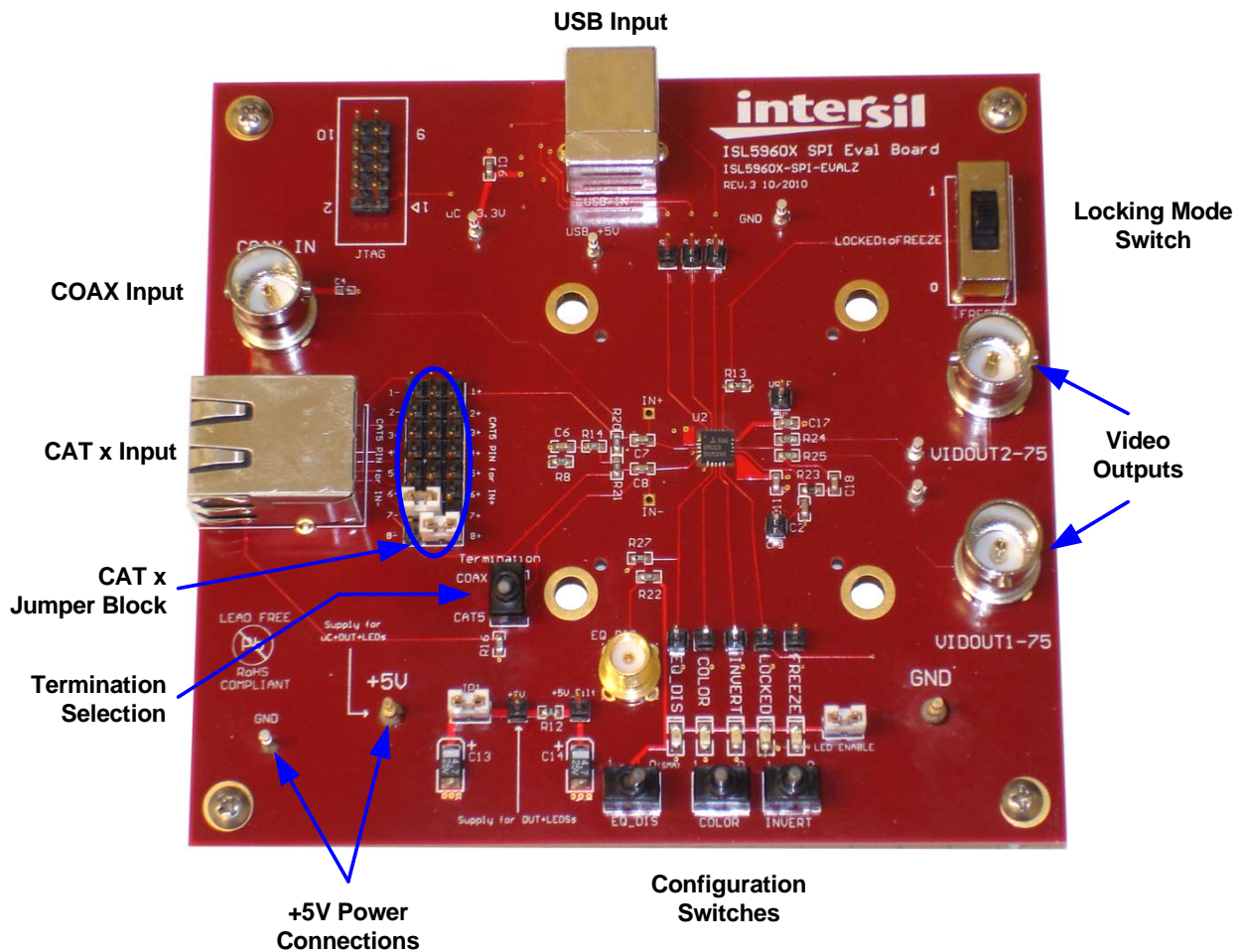

FIGURE 1. EXTERNAL CONNECTIONS AND SWITCHES

Output Connections

Standard 75Ω composite video is available at the “VIDOUT1-75” and “VIDOUT2-75” BNC connectors on the right, as well as the 2 test pins between R24/R25 and the BNC outputs.

Switch Settings

There are several switches on the evaluation board that can be used to put MegaQ™ in its different operational modes. Figure 1 shows all the switches in their recommended positions for stand-alone operation:

- **“EQ_DIS” (EQ Disable):** This can be used to disable the EQ so an external source can drive a signal over the cable. This switch should be set to the “0” position for normal operation. To drive EQ Disable with a high frequency logic signal, put the “EQ_DIS” switch into the “0” position (terminating the signal into 50Ω) and apply the signal to the SMB connector above the “EQ_DIS” switch. Note: The switch used may have a middle “open” position, but it should always be set low or high.
- **COLOR:** The Color signal can be an input or an output (see datasheet for more information). The default position for automatic color detection is the middle position (“F” for floating, i.e. not 0 or 1).
- **INVERT:** The Invert signal can be an input or an output (see datasheet for more info). The default position for automatic inversion detection and correction is the middle position (“F” for floating, i.e. not 0 or 1).
- **FREEZE:** The “FREEZE” switch determines the operational mode. The recommended mode for stand-alone operation is “Lock Until Reset”, which is the middle (“LOCKEDtoFREEZE”) position. To put MegaQ™ in the Continuous Update mode, slide the switch down to the “0” position. The “0” position should also be used when you are controlling MegaQ™ through the serial interface. The “1” position freezes the equalizer in its current state. See the datasheet for more detailed information on the locking modes.

LEDs

There are 5 LEDs at the bottom of the board that indicate the current state of the EQ_DIS, COLOR, INVERT, LOCKED, and FREEZE signals, as well as test pins for that signal directly above. The LEDs are only enabled when the LED ENABLE jumper is in place. When the LEDs are illuminated, they will draw additional supply current from the 5V supply. To accurately measure the supply current of the ISL5960x without including any LED current, remove the LED ENABLE jumper to disable the LEDs and place an ammeter in place of the JP1 jumper to measure the supply current to MegaQ™ only.

Software Installation

The next section explains how to install the GUI (Graphical User Interface) software, configure the hardware for software control, attach the board to the PC via USB, and use the GUI to control MegaQ™.

Notes

This software was developed on and will work 32-bit Windows XP. It *may* also work on some 32-bit Windows 7 platforms. **The USB driver used is not compatible with any 64-bit version of Windows.**

The software is called “ISL59605 Evaluation Software”, but it is designed to work with the entire MegaQ™ family: from the ISL59601 through the ISL59605. Some features supported by the software, such as longer equalization lengths and the noise filtering option in register 0x05, are only available on some versions of MegaQ™.

This documentation contains screen captures of the software at the time this manual was written. Subsequent software versions may appear different.

Software Installation

The ISL59605-SPI-EVALZ software may be installed from a CD-ROM accompanying the hardware or from an installer file downloaded from the Intersil web site.

Launch the "ISL59605_Installer.exe" file and follow the instructions. The default installation will add an "Intersil" directory to the "Start Menu/Programs" tree. That directory will contain a shortcut to the ISL59605 executable and an uninstaller.

The default install option installs the main program files in the C:\Program Files\Intersil\ISL59605 directory, however the location can be customized if desired. The USB driver file “windrvr6.sys” will be placed into the C:\WINDOWS\system32\drivers directory, and “usb_interface.inf” will be installed in C:\WINDOWS\INF.

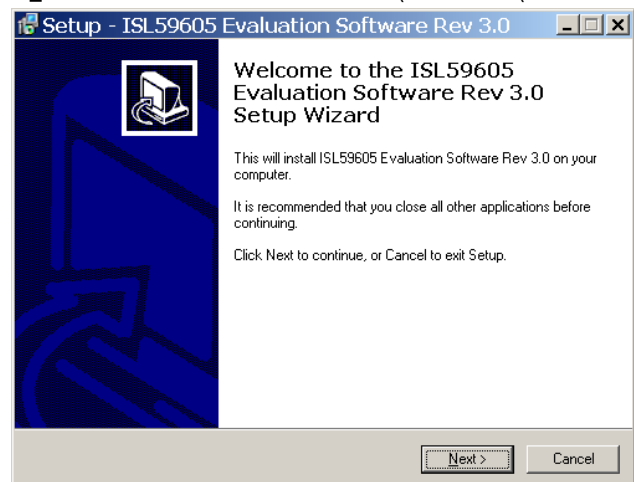

FIGURE 2. INSTALLER WINDOW

Application Note 1588

Press **Next** to continue to the license agreement.

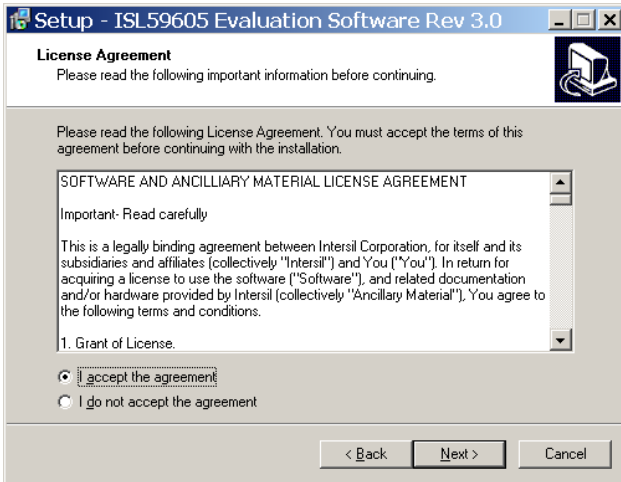

FIGURE 3. LICENSE AGREEMENT

Read the license agreement, choose to accept (or not accept) the license agreement, then click **Next**.

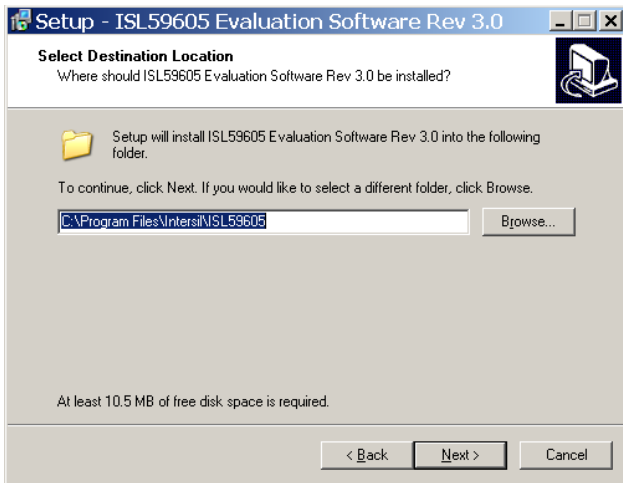

FIGURE 4. INSTALLATION DIRECTORY

By default, the installer will put the evaluation software under **C:\Program Files\Intersil\ISL59605** directory. To use a different directory, select the **Browse** button. Press **Next** to continue to the Start Menu Folder screen.

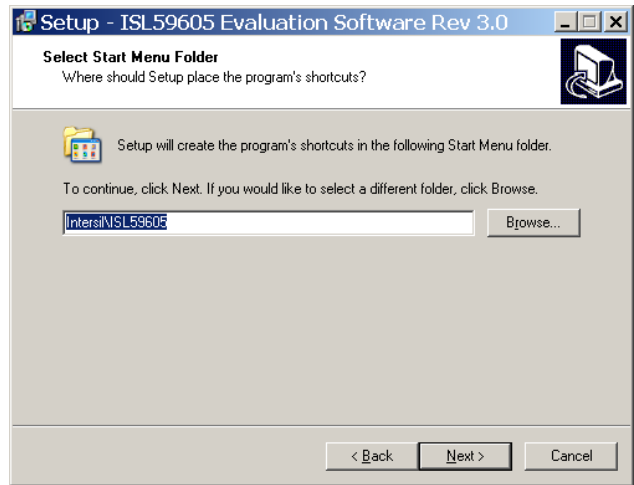

FIGURE 5. START MENU FOLDER

Press **Next** to create the Intersil folder in the Start Menu. Press

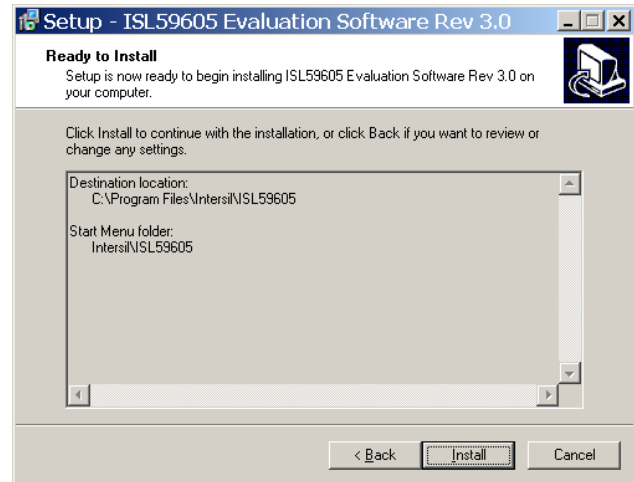

FIGURE 6. BEGIN INSTALLATION

Install to copy all the necessary files onto the PC.

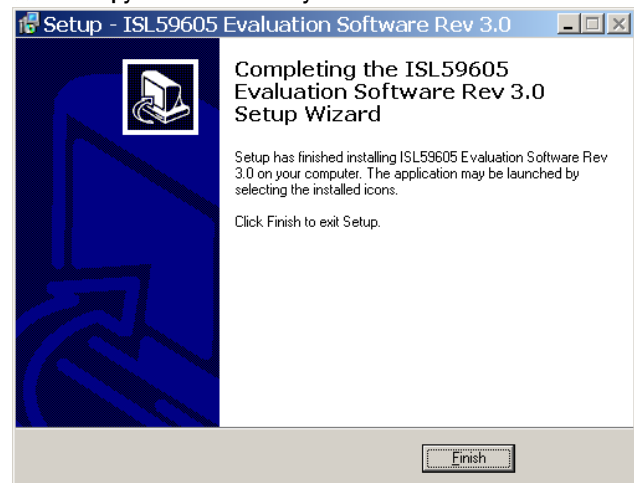

FIGURE 7. COMPLETION SCREEN

Click **Finish** to complete installation. Re-boot the PC if requested.

Hardware Setup

After the software and USB drivers have been installed, the evaluation board must be configured and powered for its initial connection to the PC.

1. Verify that all the switches are in the correct position as described in "Switch Settings" on page 3, except for the FREEZE switch. Set the FREEZE switch to the "0" position to enable software control of the ISL5960x.
2. Verify that JP1 is shorted (either with a jumper or an ammeter) so power will be applied to the IC.
3. Apply power to the +5V and GND posts.
4. Connect the evaluation board to the PC with a USB cable.

USB Driver Installation

When the evaluation board is initially connected to the PC, Windows XP may display this window:



FIGURE 8. FOUND NEW HARDWARE

If this box appears, select "No, not this time", then click **Next**, causing this screen to appear:



FIGURE 9. SOFTWARE SOURCE SELECTION

Verify that "Install the software automatically" is selected and press **Next**.

The Hardware Wizard will automatically locate and install the driver for the ISL59605:

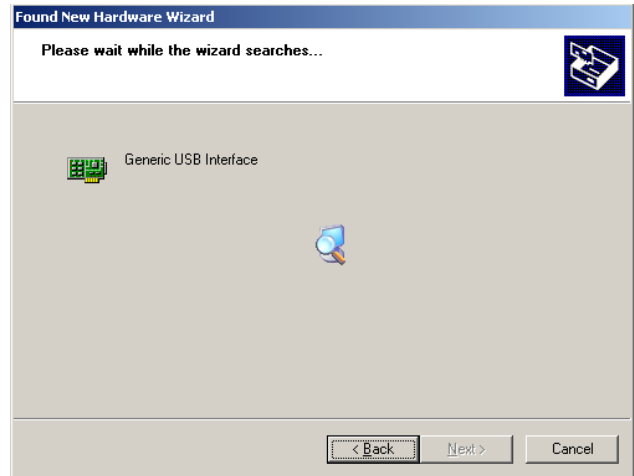

FIGURE 10. FINDING DRIVER



FIGURE 11. DRIVER IS INSTALLED

Click **Finish** to complete the installation.

On XP systems, a pop-up message may appear displaying the status of the ISL59605 hardware:

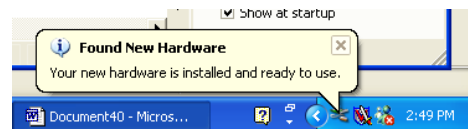

FIGURE 12. HARDWARE INSTALLED NOTIFICATION

Using the Software

Launch the software (the default location is Start Menu/Programs/Intersil/ISL59605).

After the program has launched, you should see the following screen:

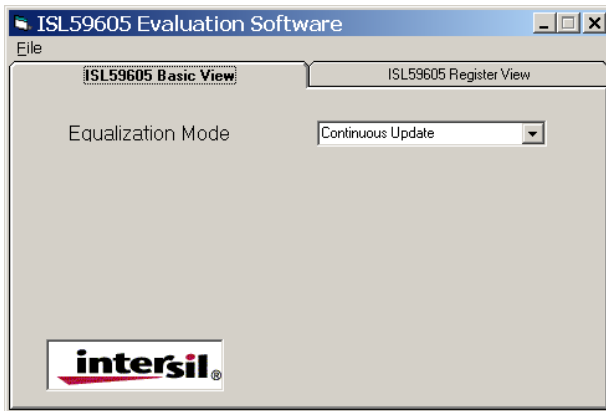

FIGURE 13. BASIC VIEW

ISL59605 Basic View

Basic View is a simple interface for controlling the Equalization Mode.

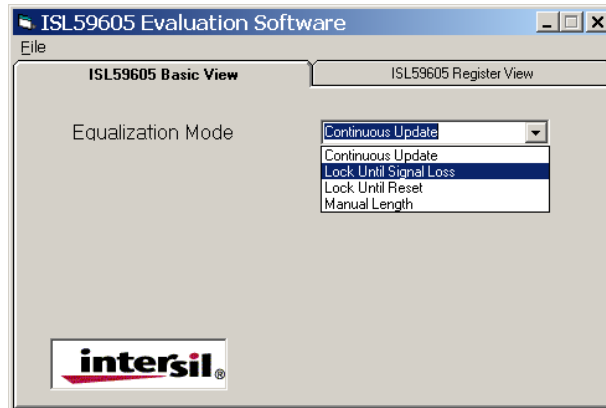

FIGURE 14. EQUALIZATION MODE SELECTION

Using this tab, the user can select between the four equalization modes. The first three modes are various forms of automatic equalization, the last is manual length control (not a particularly useful feature, since the auto EQ almost always equalizes as well as or better than manual, but it may be of some experimental interest):

1. Continuous Update (also available in stand-alone)
2. Lock until Signal Loss
3. Lock until Reset (also available in stand-alone)
4. Manual Length

When the "Manual Length" mode is selected, the slider becomes active and the equalization may be manually adjusted to match the length of cable. In manual mode, the Cable Type also needs to be set. The length control is calibrated for Cat 5/6 cable, not coax. Length settings longer than the part is capable of (e.g. 4000 feet with an ISL59601) will have no effect - a part can not equalize farther than the distance it is designed to go.

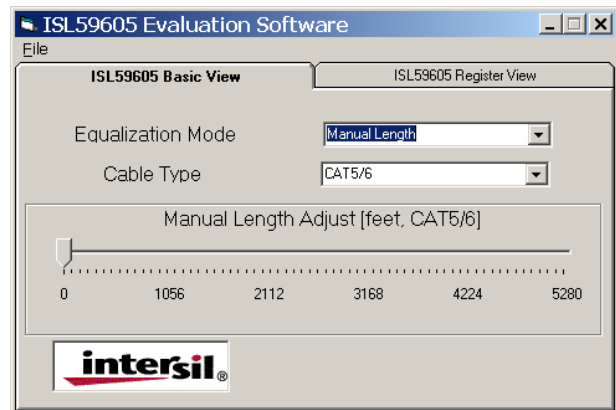

FIGURE 15. BASIC VIEW OPTIONS FOR MANUAL MODE

ISL59605 Register View

This tab allows user to directly see and modify the contents of the MegaQ™ registers. To update the register contents, click **Read All Registers**.

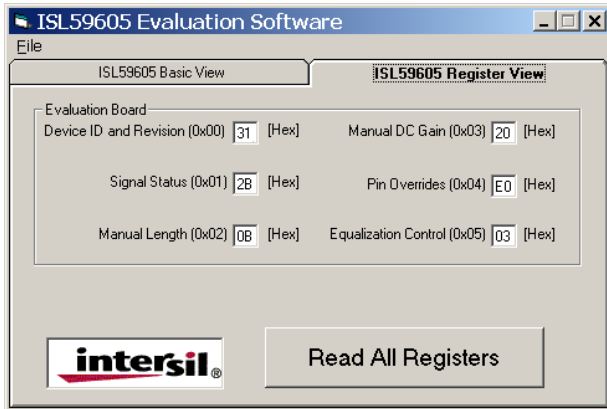

FIGURE 16. REGISTER VIEW

To change a register value, simply type the desired hexadecimal number into the appropriate box. To change both digits of the 2-digit hex number, select both digits with the mouse or by double-clicking inside the text box (03), then quickly type both digits of the desired value. If you type too slowly (more than ~1 second between the first and second digit), the first digit typed will become the lower nibble, and the higher nibble will be 0. To change one nibble using the keyboard, select the high nibble (03) or the low nibble (03) and type the new hexadecimal value. It is not necessary to press the Enter button; the software will automatically send the new value to the ISL59605-SPI-EVALZ Evaluation board.

You can also increment and decrement the register values using the keyboard:

- Up Arrow Key: Increment by 1
- Down Arrow Key: Decrement by 1
- Page Up Key: Increment by 16 (increment high nibble by 1)
- Page Down Key: Decrement by 16 (decrement high nibble by 1)

ISL59605 Detailed Register View

Right-clicking on any register label brings up a detailed bit-level description of each register. If the register has individual bit functions, they will come up as check boxes that can be checked or unchecked.

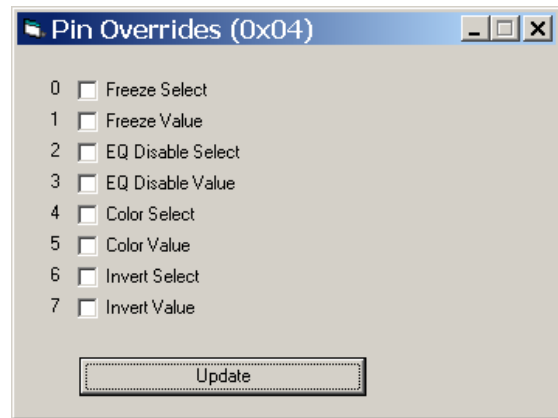

FIGURE 17. PIN OVERRIDE

If the register has grouped bits, they come up as text boxes that can be written to with the desired hex values:

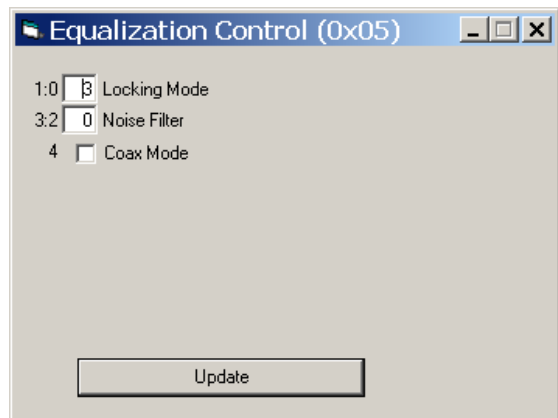

FIGURE 18. EQUALIZATION CONTROL

After the desired data has been entered, click "Update" to send the data to the device. The register view will be automatically updated.

Saving and Loading Registers

To save all the registers values to a text delimited file, select the "Save Registers" option from the File menu.

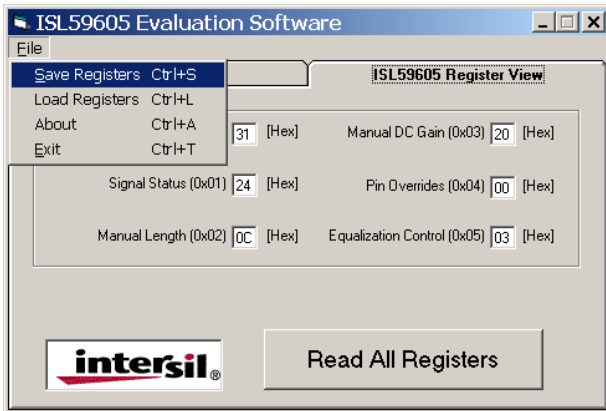

FIGURE 19. SAVING A REGISTER SET

Enter a filename and extension when prompted, and the program will save the file with that extension.

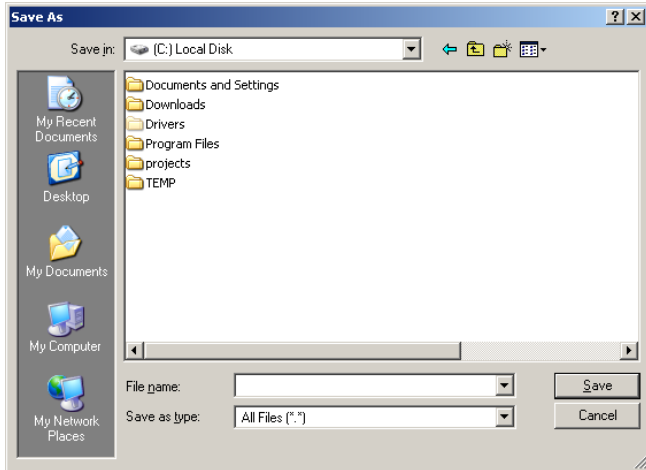

FIGURE 20. REGISTER SAVE DIALOG

Once saved, register files can be loaded using the "Load Registers" function.

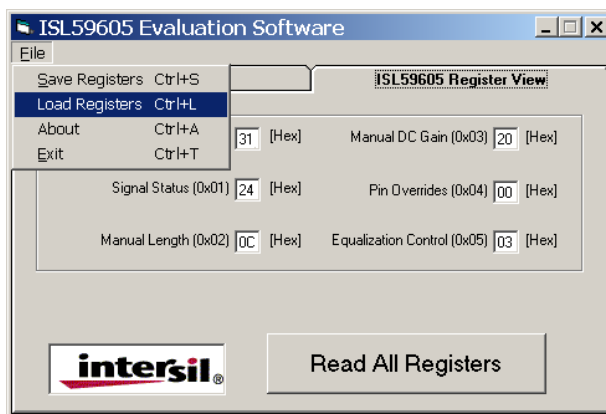

FIGURE 21. LOADING A REGISTER SET

Please refer to the ISL59605 datasheet for a more detailed description of the registers.

Related Documents

- ISL5960x Datasheet ([FN6739](#))
- ISL59605-SPI-EVALZ Evaluation Board (with Serial Interface) Operation (Rev 5.0) ([AN1775](#))
- ISL59605-Catx-EVZ Evaluation Board ([AN1780](#))
- ISL59603-Coax-EVZ Evaluation Board ([AN1776](#))

Troubleshooting

Analog (ISL5960x) Troubleshooting

1. Verify that all the switches are in the correct position as described in "Switch Settings" on page 3.
2. Verify that JP1 is shorted (either with a jumper or an ammeter) so power will be applied to the IC.
3. Verify that there is 5V across the power supply pins, and that the board is drawing ~80mA of current. If you are seeing less current, JP1 may be open or the EQ_DIS switch may be set to the wrong position.
4. Probe the IN+ and IN- pins for a video signal. For Cat x inputs, you should see a signal on both inputs (with IN- being the inverse of the signal on IN+). For coax inputs, you should see a signal on IN+ and a DC voltage on IN-. If you do not see the expected signals, inspect your cables, video sources, etc. For Cat x signals, verify that the jumpers in the jumper block are set correctly. If you are not certain which pair of Cat x wires is carrying the signal, you can probe the middle row of 8 pins in the jumper block, where you should see the signal on 2 of them.
5. If you see the correct input signal on IN+ and IN- but are still not seeing a valid output signal, toggle the INVERT switch high and low and then back to the center position to reset the chip.
6. Probe the VIDOUT2-75 test pin with a scope to see if there is a video signal. If you see a composite video signal, inspect your cables, video receiver, etc.
7. Verify that the FREEZE switch is in the correct position: "0" or "LOCKEDtoFREEZE" for stand-alone operation; "0" for software control.

USB Driver Troubleshooting

The software should be able to communicate with the evaluation board as soon as it is launched. If there is a communication problem, the following dialog box may be displayed:



FIGURE 22. DEVICE NOT CONNECTED

Application Note 1588

After rebooting the PC, please verify that the following files are in the following locations:

- windrvr6.sys in C:\WINDOWS\system32\Driver
- usb_interface.inf in C:\WINDOWS\INF
- ISL59605.exe in C:\Program Files\Intersil\ISL59605

If you do see this dialog, open the Windows Control Panel. Double-click on the "System" icon, select the "Hardware" tab, then click on Device Manager:

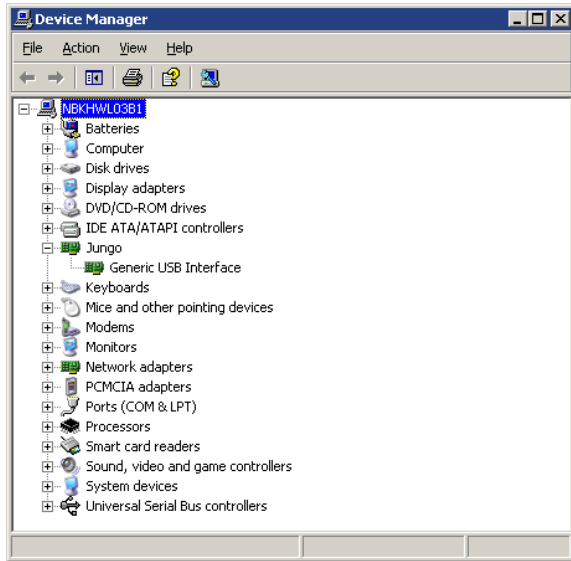
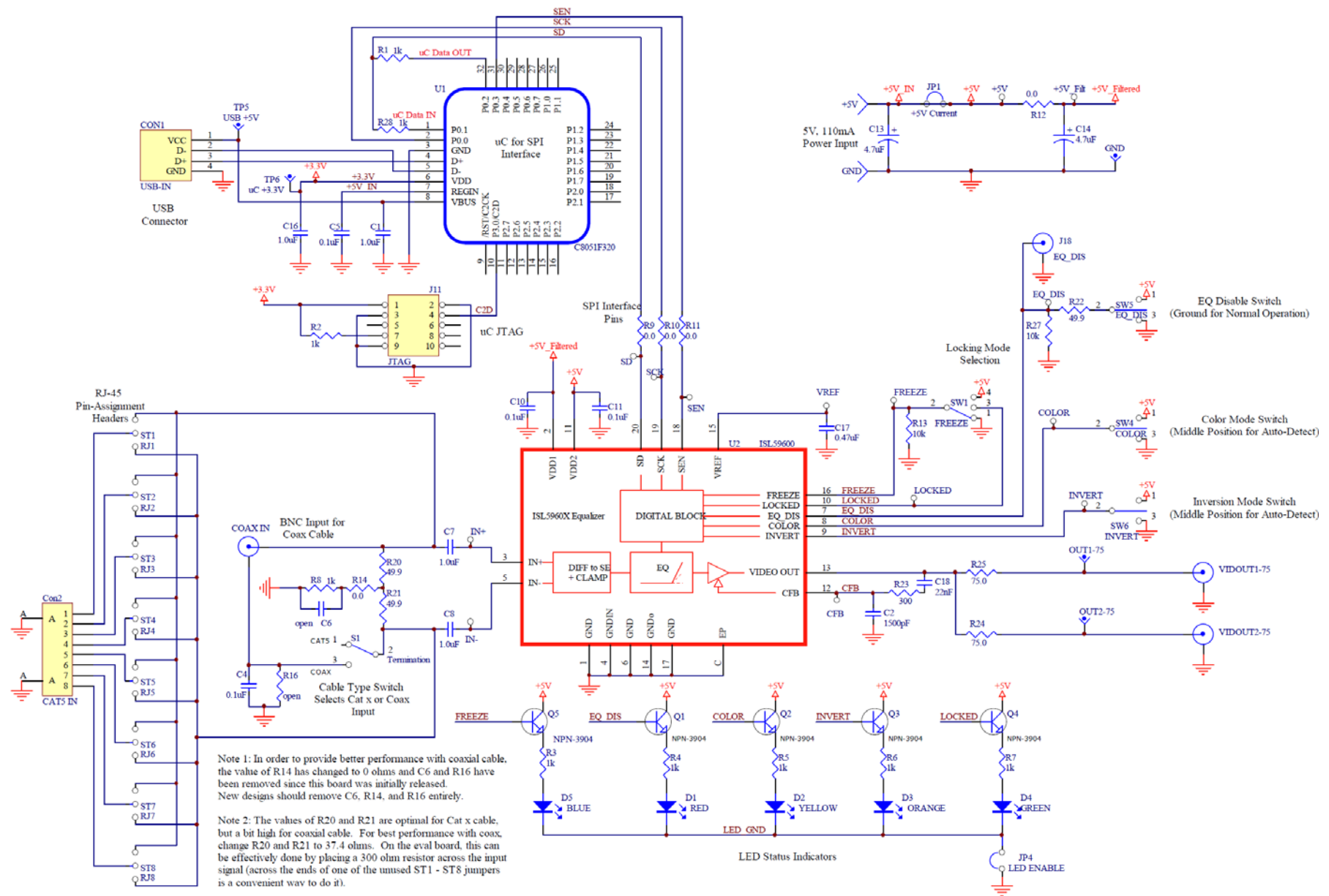

FIGURE 23. DEVICE MANAGER

There should be a "Jungo" entry, with an "Generic USB Interface" sub category. This indicates the driver is properly installed and is communicating with the evaluation board. If this is not visible, or there are any error messages, try the following actions:

- Verify that the evaluation board has power and the USB cable is connecting the evaluation board and the PC.
- Disconnect then reconnect the USB cable. You should hear 2 tones from the PC's speakers when the USB device is enumerated.
- Cycle power to the board.
- Close all instances of the ISL59605 application and restart the software. Restart the PC if necessary.
- If none of this works, try installing the software on a different PC isolate the cause to the PC vs. the evaluation board.
- Note: The ISL59605-SPI-EVALZ Evaluation Board has a USB Vendor ID (VID) of 0x09AA and Product ID (PID) of 0x200D.

ISL59605-SPI-EVALZ Evaluation Board Schematic



ISL59605-SPI-EVALZ Board Layout

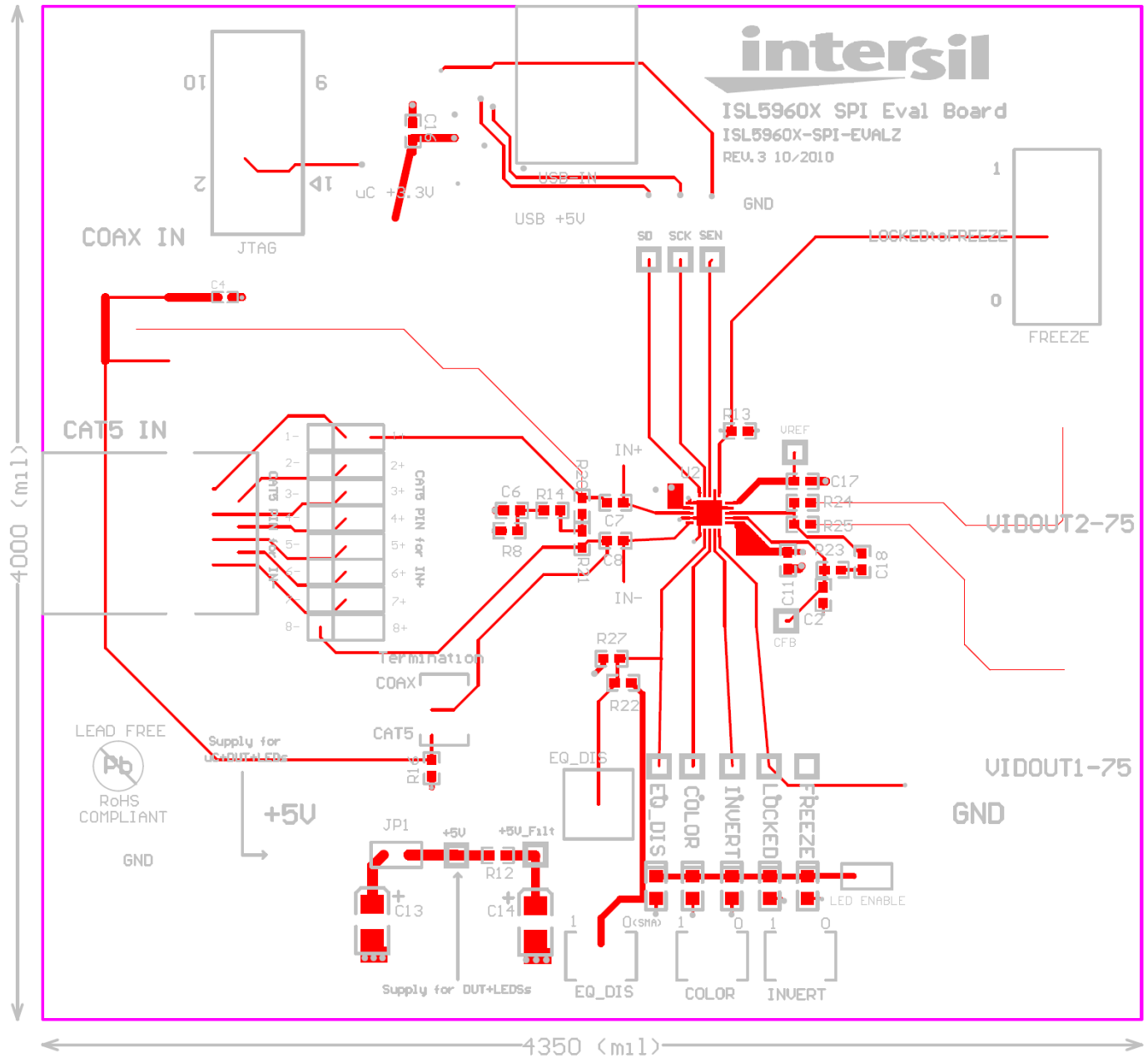

FIGURE 24. PCB TOP LAYER WITH SILKSCREEN

ISL59605-SPI-EVALZ Board Layout (Continued)

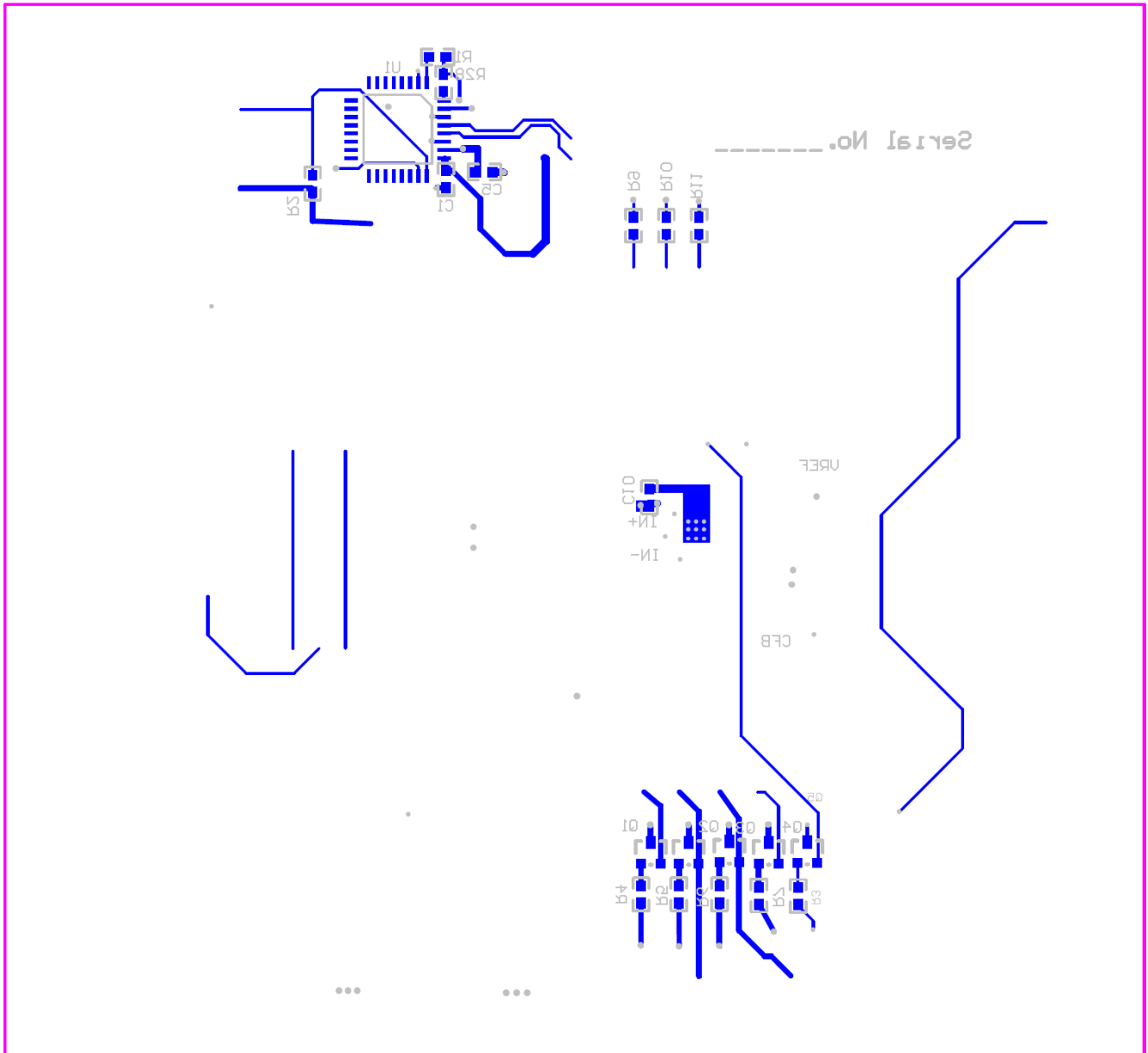

FIGURE 25. PCB BOTTOM LAYER WITH SILKSCREEN

ISL59605-SPI-EVALZ Board Layout (Continued)

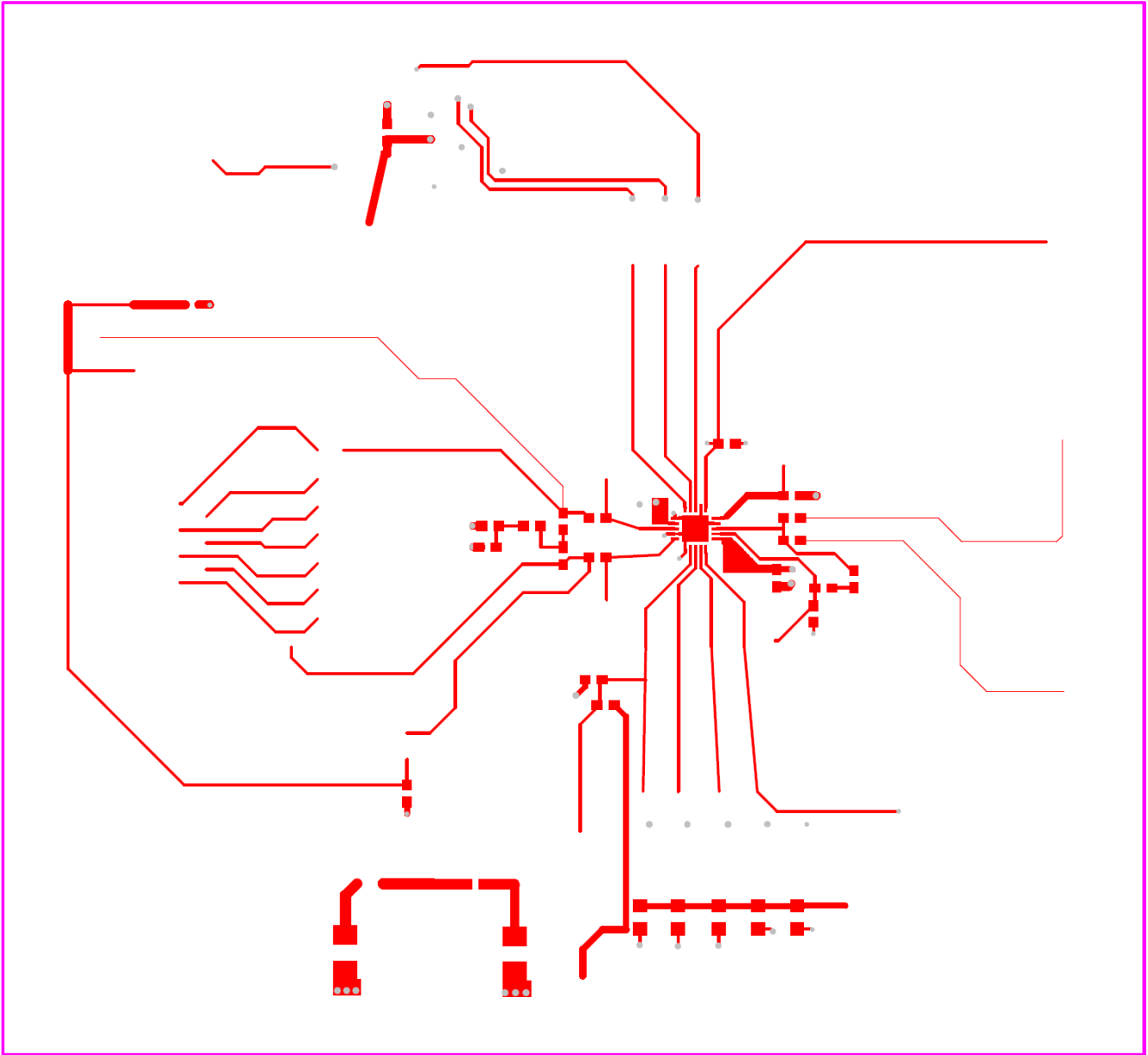

FIGURE 26. PCB TOP LAYER

ISL59605-SPI-EVALZ Board Layout (Continued)

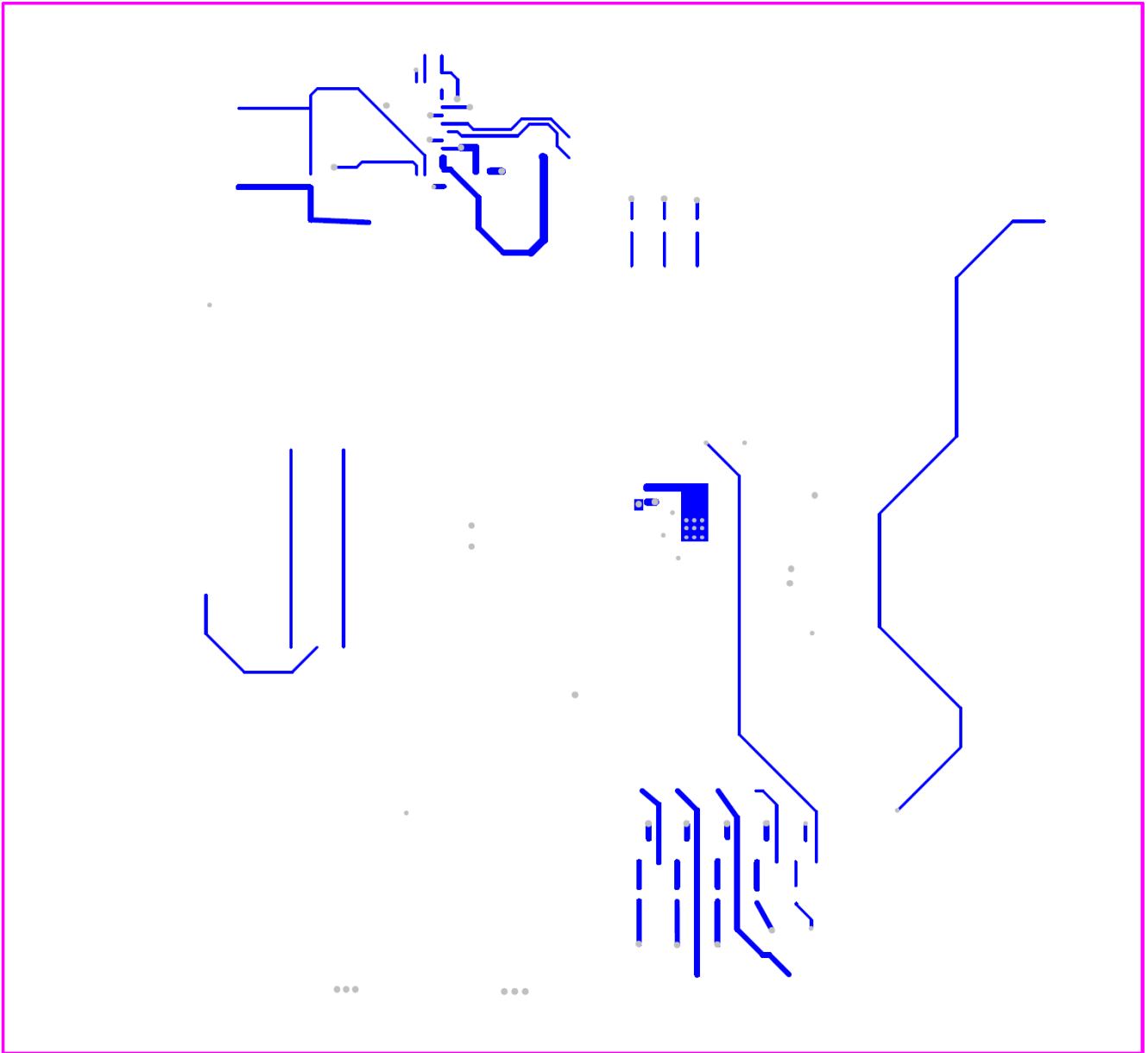

FIGURE 27. PCB BOTTOM LAYER

ISL59605-SPI-EVALZ Board Layout (Continued)

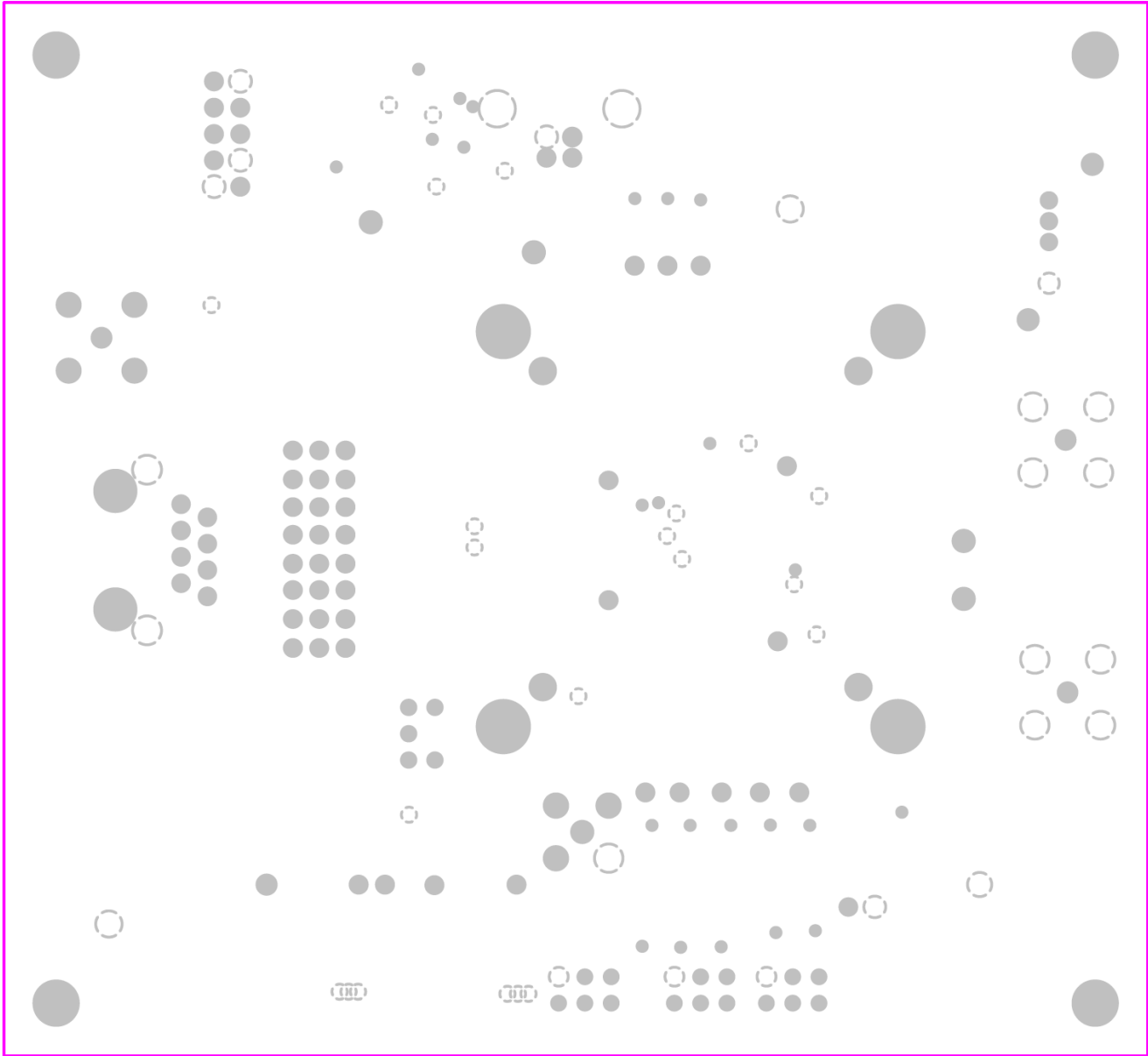

FIGURE 28. PCB INTERNAL PLANE 1 (GROUND)

ISL59605-SPI-EVALZ Board Layout (Continued)

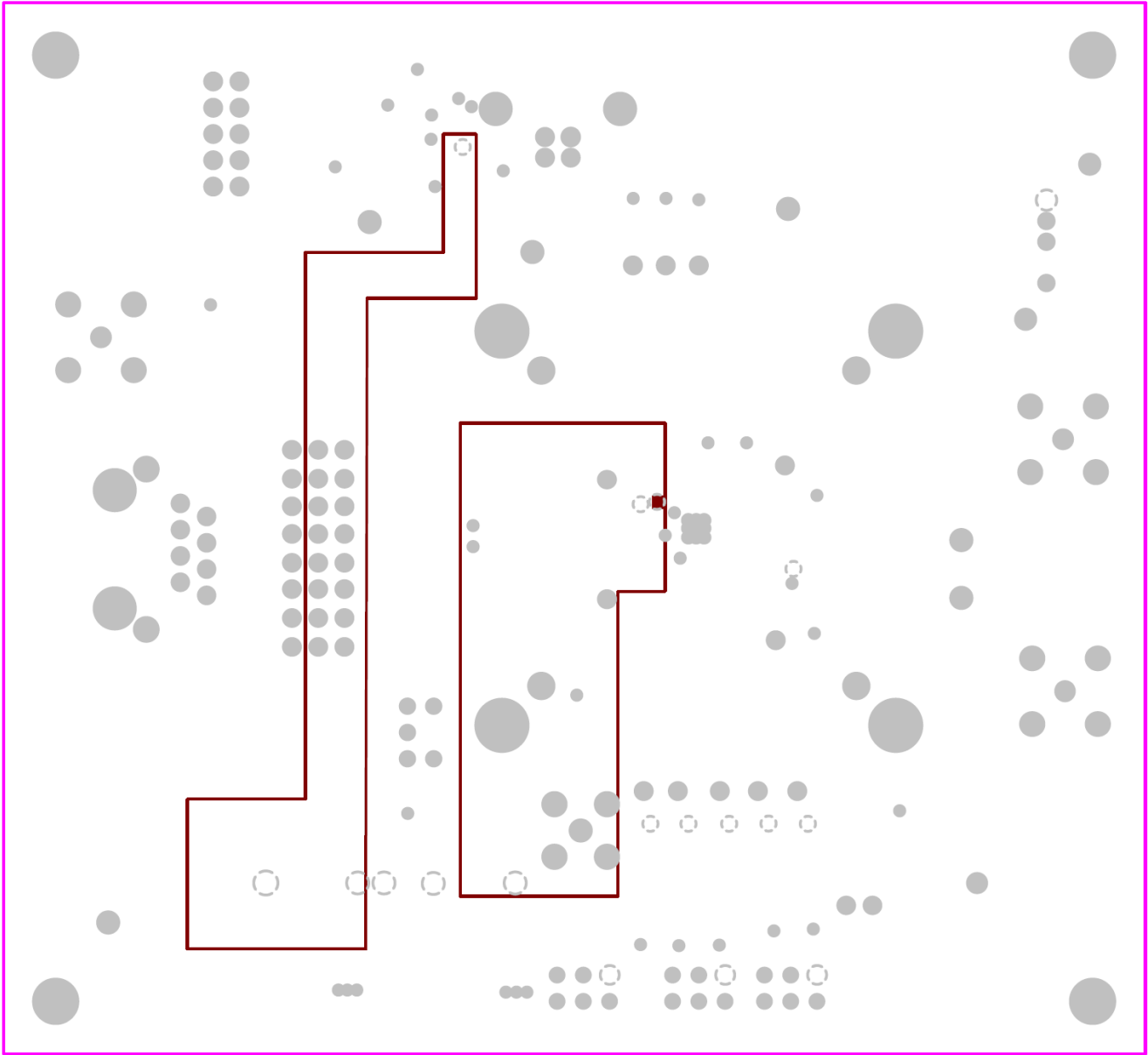

FIGURE 29. PCB INTERNAL PLANE 2 (POWER)

Application Note 1588

Bill of Materials

QUANTITY	COMPONENT NAME	VALUE	FOOTPRINT
1	U2	ISL59605	QFN20 4MM
4	C1, C7, C8, C16	1.0 μ F	603
1	C2	1500pF	603
1	C4	0.1 μ F	402
4	C5, C6, C10, C11	0.1 μ F	603
2	C13, C14	4.7 μ F	3528
1	C17	0.47 μ F	603
1	C18	22nF	603
1	CON1	USB TYPE B FEMALE	USB TYPE-B(926)
1	CON2	CAT5 IN	Modular-8S
1	D1	RED	LED-0805
1	D2	YELLOW	LED-0805
1	D3	ORANGE	LED-0805
1	D4	GREEN	LED-0805
1	D5	BLUE	LED-0805
14	J1, J4, J5, J6, J7, J8, J12, J13, J15, J16, J17, J19, J20, J21	TEST POINTS	HEADER-1 PIN
2	J2, J3	POWER SUPPLY POSTS	POWERPOST
1	J11	JTAG	HEADER-10P SHROUDED
1	J18	SMB CONNECTOR	SMC/SMB
2	JP1, JP4	2-PIN JUMPER	JUMPER-2PIN
3	P1, P2, P3	BNC	BNC
5	Q1, Q2, Q3, Q4, Q5	NPN-3904	SOT-23
9	R1, R2, R3, R4, R5, R6, R7, R8, R28	1k	603
4	R9, R10, R11, R12	0	603
2	R13, R27	10k	603
1	R14	50	603
1	R16	10	603
3	R20, R21, R22	49.9	603
1	R23	300	603
2	R24, R25	75	603
1	S1	SP2T SWITCH	SWITCH-TOGGLE-GT11MCKE
1	SW1	FREEZE	SWITCH SP3T SLIDE-TH
3	SW4, SW5, SW6	SP2T SWITCH WITH NC	SWITCH-G13AP-ON-OFF-ON
8	ST1, ST2, ST3, ST4, ST5, ST6, ST7, ST8	3 PIN JUMPER	JUMPER-3PIN
6	TP1, TP2, TP5, TP6, TP14, TP15	GND	TESTPOINT
1	U1	C8051F320	LQFP32

Intersil Corporation reserves the right to make changes in circuit design, software and/or specifications at any time without notice. Accordingly, the reader is cautioned to verify that the Application Note or Technical Brief is current before proceeding.

For information regarding Intersil Corporation and its products, see www.intersil.com