



KT5W-2P1126D

KT5

CONTRAST SENSORS

SICK
Sensor Intelligence.



Ordering information

Type	Part no.
KT5W-2P1126D	1026579

Other models and accessories → www.sick.com/KT5



Detailed technical data

Features

Dimensions (W x H x D)	30.4 mm x 53 mm x 80 mm
Sensing distance	10 mm ¹⁾
Sensing distance tolerance	± 3 mm
Housing design (light emission)	Rectangular
Light source	LED, RGB ²⁾
Wave length	470 nm, 525 nm, 640 nm
Light emission	Long and short side of housing, exchangeable
Light spot size	1.2 mm x 4.2 mm
Light spot direction	Vertical ³⁾
Adjustment	Teach-in button
Teach-in mode	Static 2-point teach-in with manual fine adjustment

¹⁾ From front edge of lens.

²⁾ Average service life: 100,000 h at T_J = +25 °C.

³⁾ In relation to long side of housing.

Mechanics/electronics

Supply voltage	10 V DC ... 30 V DC ¹⁾
Ripple	≤ 5 V _{pp} ²⁾
Power consumption	< 130 mA ³⁾
Switching frequency	10 kHz ⁴⁾

¹⁾ Limit values when operated in short-circuit protected network: max. 8 A.

²⁾ May not exceed or fall below U_v tolerances.

³⁾ Without load.

⁴⁾ With light/dark ratio 1:1.

⁵⁾ Signal transit time with resistive load.

⁶⁾ Short-circuit protected.

⁷⁾ Reference voltage DC 50 V.

Response time	50 μ s ⁵⁾
Switching output	PNP
Switching output (voltage)	PNP: HIGH = $V_S - \leq 2$ V / LOW approx. 0 V
Output current I_{max}.	100 mA ⁶⁾
Input, teach-in (ET)	PNP Teach: U = 10 V ... < U_V Run: U < 2 V
Retention time (ET)	25 ms, non-volatile memory
Time delay	20 ms
Connection type	Male connector M12, 5-pin
Protection class	II ⁷⁾
Circuit protection	U_V connections, reverse polarity protected Output Q short-circuit protected Interference pulse suppression
Enclosure rating	IP67
Weight	400 g
Housing material	Zinc diecast

1) Limit values when operated in short-circuit protected network: max. 8 A.

2) May not exceed or fall below U_V tolerances.

3) Without load.

4) With light/dark ratio 1:1.

5) Signal transit time with resistive load.

6) Short-circuit protected.

7) Reference voltage DC 50 V.

Ambient data

Ambient operating temperature	-10 °C ... +55 °C
Ambient storage temperature	-25 °C ... +75 °C
Shock load	According to IEC 60068

Classifications

ECl@ss 5.0	27270906
ECl@ss 5.1.4	27270906
ECl@ss 6.0	27270906
ECl@ss 6.2	27270906
ECl@ss 7.0	27270906
ECl@ss 8.0	27270906
ECl@ss 8.1	27270906
ECl@ss 9.0	27270906
ETIM 5.0	EC001820
ETIM 6.0	EC001820
UNSPSC 16.0901	39121528

Dimensional drawing (Dimensions in mm (inch))

KT5-2 Teach-in, KT5-2 Display

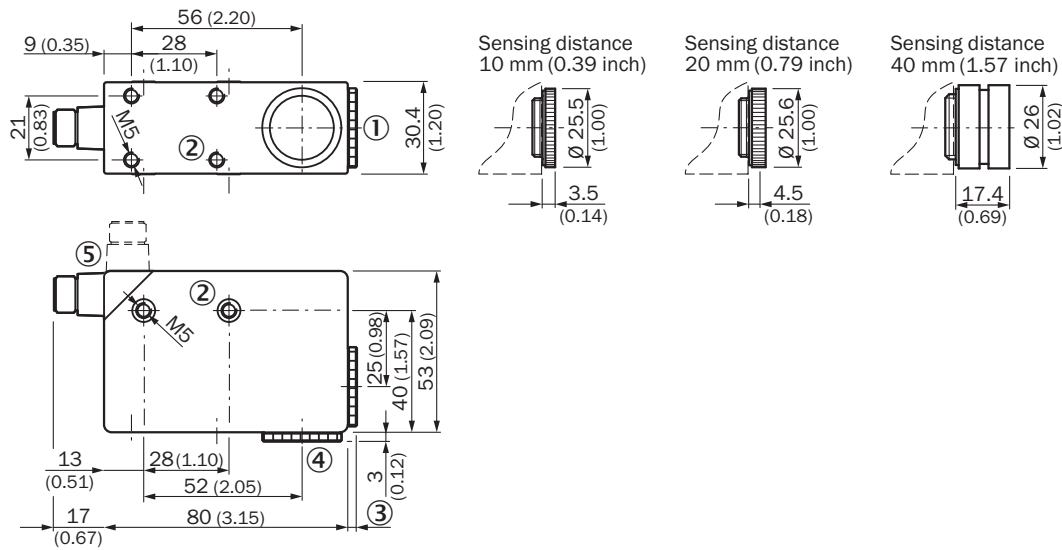

- ① Lens (light transmission), can be exchanged for pos. 4
- ② M5 threaded mounting hole, 5.5 mm deep
- ③ See dimensional drawings of lenses
- ④ Blind screw can be replaced by pos. 1
- ⑤ Connector M12 (rotatable up to 90°)

Adjustments

KT5-2 Display

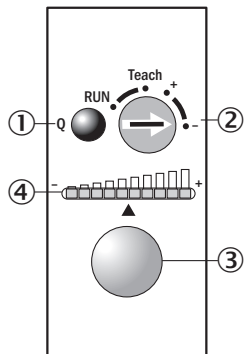

- ① Function signal indicator (yellow)
- ② Pre-selection switch
- ③ Teach-in button
- ④ Bar graph (green)

Connection diagram

cd-323



Concept of operation

KT5-2 Display, Teach-in static

1. Position mark

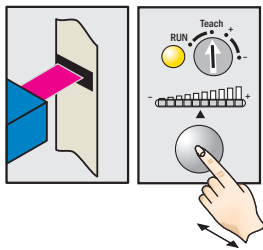

Turn rotary switch to "Teach" position. Press and hold teach-in button > 1 s. Red emitted light and yellow LED flash.

2. Position background

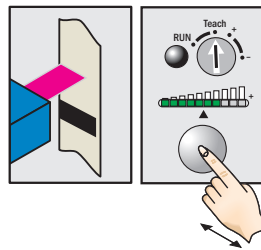

Press and hold teach-in button > 1 s. Yellow LED goes out. Optimum emitted light is selected.

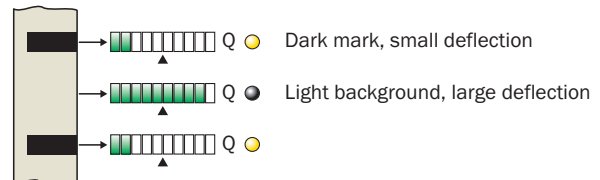

Fine adjustment possible using the "+" / "-" buttons.

Note

The bar display visualizes the detection reliability during teach-in. The more LEDs that illuminate, the better the teach-in:

- 1 LED illuminates = operation not reliable – contrast difference too low
- ≤ 4 LEDs illuminate = operation OK – sufficient contrast difference
- > 4 LEDs illuminate = reliable operation – high contrast difference

Example

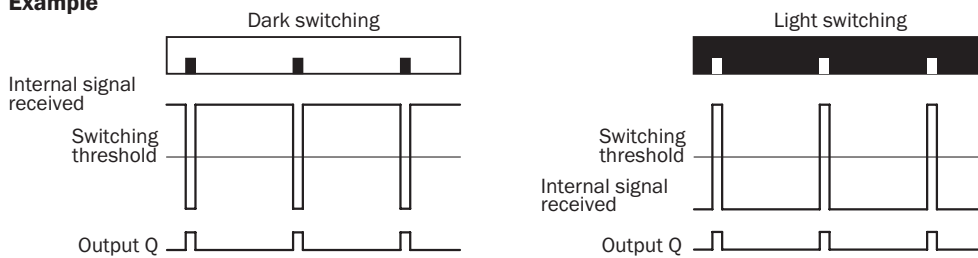

Switching characteristics

The optimum emitted light is selected automatically. Light/dark setting is defined using teach-in sequence. The switching threshold is set in the center between the background and the mark. Teach-in can also be performed using an external control signal.

Characteristic curve





KT5-2 Teach-in, KT5G, KT5W, KT5-2 Display



- ① Sensing distance 10 mm
- ② Sensing distance 20 mm
- ③ Sensing distance 40 mm

Recommended accessories

Other models and accessories → www.sick.com/KT5

	Brief description	Type	Part no.
Universal bar clamp systems			
	Plate G for universal clamp bracket, steel, zinc coated, Universal clamp (2022726), mounting hardware	BEF-KHS-G01	2022464
	Plate K for universal clamp bracket, steel, zinc coated, Universal clamp (2022726), mounting hardware	BEF-KHS-K01	2022718
	Universal clamp bracket for rod mounting, steel, zinc coated, without mounting hardware	BEF-KHS-KH1	2022726
	Mounting bar, straight, 200 mm, steel, steel, zinc coated, without mounting hardware	BEF-MS12G-A	4056054
	Mounting bar, straight, 300 mm, steel, steel, zinc coated, without mounting hardware	BEF-MS12G-B	4056055
	Mounting bar, L-shaped, 150 mm x 150 mm, steel, steel, zinc coated, without mounting hardware	BEF-MS12L-A	4056052
	Mounting bar, L-shaped, 250 x 250 mm, steel, steel, zinc coated, without mounting hardware	BEF-MS12L-B	4056053

	Brief description	Type	Part no.
Plug connectors and cables			
	Head A: female connector, M12, 5-pin, straight, A-coded Head B: Flying leads Cable: Sensor/actuator cable, PVC, unshielded, 2 m	YF2A15-020VB5XLEAX	2096239
	Head A: female connector, M12, 5-pin, straight, A-coded Head B: Flying leads Cable: Sensor/actuator cable, PVC, unshielded, 5 m	YF2A15-050VB5XLEAX	2096240
	Head A: female connector, M12, 5-pin, straight, A-coded Head B: Flying leads Cable: Sensor/actuator cable, PVC, unshielded, 10 m	YF2A15-100VB5XLEAX	2096241
	Head A: female connector, M12, 5-pin, angled, A-coded Head B: Flying leads Cable: Sensor/actuator cable, PVC, unshielded, 2 m	YG2A15-020VB5XLEAX	2096215
	Head A: female connector, M12, 5-pin, angled, A-coded Head B: Flying leads Cable: Sensor/actuator cable, PVC, unshielded, 5 m	YG2A15-050VB5XLEAX	2096216
	Head A: female connector, M12, 5-pin, angled, A-coded Head B: Flying leads Cable: Sensor/actuator cable, PVC, unshielded, 10 m	YG2A15-100VB5XLEAX	2096217
	Head A: female connector, M12, 5-pin, straight Cable: unshielded	DOS-1205-G	6009719
	Head A: female connector, M12, 5-pin, angled Head B: - Cable: unshielded	DOS-1205-W	6009720
Lenses and accessories			
	Lens, 40 mm sensing distance, M20 x 0.75	OBJ-210	2010945
	Lens, 10 mm sensing distance, M20 x 0.75	OBJ-211	1004936
	Lens, 20 mm sensing distance, M20 x 0.75	OBJ-212	1011506

SICK AT A GLANCE

SICK is one of the leading manufacturers of intelligent sensors and sensor solutions for industrial applications. A unique range of products and services creates the perfect basis for controlling processes securely and efficiently, protecting individuals from accidents and preventing damage to the environment.

We have extensive experience in a wide range of industries and understand their processes and requirements. With intelligent sensors, we can deliver exactly what our customers need. In application centers in Europe, Asia and North America, system solutions are tested and optimized in accordance with customer specifications. All this makes us a reliable supplier and development partner.

Comprehensive services complete our offering: SICK LifeTime Services provide support throughout the machine life cycle and ensure safety and productivity.

For us, that is “Sensor Intelligence.”

WORLDWIDE PRESENCE:

Contacts and other locations –www.sick.com