

## Cool MOS™ Power Transistor

### Feature

- New revolutionary high voltage technology
- Ultra low gate charge
- Periodic avalanche rated
- Extreme  $dv/dt$  rated
- Ultra low effective capacitances
- Improved transconductance
- Pb-free lead plating; RoHS compliant
- Qualified according to JEDEC<sup>0)</sup> for target applications

$V_{DS} @ T_{jmax}$	650	V
$R_{DS(on)}$	6	$\Omega$
$I_D$	0.8	A

PG-TO252

PG-TO251

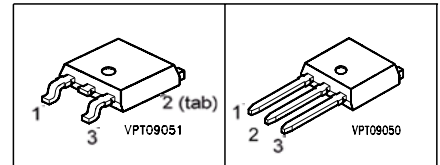

Type	Package	Ordering Code	Marking
SPU01N60C3	PG-TO251	Q67040-S4193	01N60C3
SPD01N60C3	PG-TO252	Q67040-S4188	01N60C3

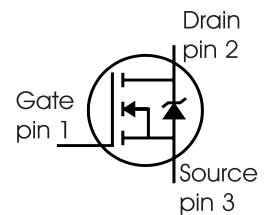

### Maximum Ratings

Parameter	Symbol	Value	Unit
Continuous drain current $T_C = 25\text{ °C}$ $T_C = 100\text{ °C}$	$I_D$	0.8 0.5	A
Pulsed drain current, $t_p$ limited by $T_{jmax}$	$I_{D\text{ puls}}$	1.6	
Avalanche energy, single pulse $I_D = 0.6\text{ A}$ , $V_{DD} = 50\text{ V}$	$E_{AS}$	20	mJ
Avalanche energy, repetitive $t_{AR}$ limited by $T_{jmax}$ <sup>1)</sup> $I_D = 0.8\text{ A}$ , $V_{DD} = 50\text{ V}$	$E_{AR}$	0.01	
Avalanche current, repetitive $t_{AR}$ limited by $T_{jmax}$	$I_{AR}$	0.8	A
Gate source voltage static	$V_{GS}$	$\pm 20$	V
Gate source voltage AC ( $f > 1\text{ Hz}$ )	$V_{GS}$	$\pm 30$	
Power dissipation, $T_C = 25\text{ °C}$	$P_{tot}$	11	W
Operating and storage temperature	$T_j, T_{stg}$	-55... +150	$^{\circ}\text{C}$
Reverse diode $dv/dt$ <sup>3)</sup>	$dv/dt$	15	V/ns

### Maximum Ratings

Parameter	Symbol	Value	Unit
Drain Source voltage slope $V_{DS} = 480 \text{ V}, I_D = 0.8 \text{ A}, T_j = 125 \text{ }^\circ\text{C}$	$dv/dt$	50	V/ns

### Thermal Characteristics

Parameter	Symbol	Values			Unit
		min.	typ.	max.	
Thermal resistance, junction - case	$R_{thJC}$	-	-	11	K/W
Thermal resistance, junction - ambient, leaded	$R_{thJA}$	-	-	75	
SMD version, device on PCB: @ min. footprint @ 6 cm <sup>2</sup> cooling area <sup>2)</sup>	$R_{thJA}$	-	-	75 50	
Soldering temperature, *) 1.6 mm (0.063 in.) from case for 10s	$T_{sold}$	-	-	260	°C

### Electrical Characteristics, at $T_j=25^\circ\text{C}$ unless otherwise specified

Parameter	Symbol	Conditions	Values			Unit
			min.	typ.	max.	
Drain-source breakdown voltage	$V_{(BR)DSS}$	$V_{GS}=0\text{V}, I_D=0.25\text{mA}$	600	-	-	V
Drain-Source avalanche breakdown voltage	$V_{(BR)DS}$	$V_{GS}=0\text{V}, I_D=0.8\text{A}$	-	700	-	
Gate threshold voltage	$V_{GS(th)}$	$I_D=250\mu\text{A}, V_{GS}=V_{DS}$	2.1	3	3.9	
Zero gate voltage drain current	$I_{DSS}$	$V_{DS}=600\text{V}, V_{GS}=0\text{V},$ $T_j=25^\circ\text{C},$ $T_j=150^\circ\text{C}$	-	0.1	1 50	$\mu\text{A}$
Gate-source leakage current	$I_{GSS}$	$V_{GS}=30\text{V}, V_{DS}=0\text{V}$	-	-	100	
Drain-source on-state resistance	$R_{DS(on)}$	$V_{GS}=10\text{V}, I_D=0.5\text{A},$ $T_j=25^\circ\text{C}$ $T_j=150^\circ\text{C}$	-	5.6 15.1	6 -	$\Omega$
			-			

\*) TO252: reflow soldering, MSL3; TO251: wavesoldering

**Electrical Characteristics** , at  $T_j = 25\text{ }^\circ\text{C}$ , unless otherwise specified

Parameter	Symbol	Conditions	Values			Unit
			min.	typ.	max.	
Transconductance	$g_{fs}$	$V_{DS} \geq 2 \cdot I_D \cdot R_{DS(on)max}$ , $I_D = 0.5\text{A}$	-	0.75	-	S
Input capacitance	$C_{iss}$	$V_{GS} = 0\text{V}$ , $V_{DS} = 25\text{V}$ , $f = 1\text{MHz}$	-	100	-	pF
Output capacitance	$C_{oss}$		-	40	-	
Reverse transfer capacitance	$C_{rss}$		-	2.5	-	
Turn-on delay time	$t_{d(on)}$	$V_{DD} = 350\text{V}$ , $V_{GS} = 0/10\text{V}$ , $I_D = 0.8\text{A}$ , $R_G = 100\Omega$	-	30	-	ns
Rise time	$t_r$		-	25	-	
Turn-off delay time	$t_{d(off)}$		-	55	82	
Fall time	$t_f$		-	30	45	

**Gate Charge Characteristics**

Gate to source charge	$Q_{gs}$	$V_{DD} = 350\text{V}$ , $I_D = 0.8\text{A}$	-	0.9	-	nC
Gate to drain charge	$Q_{gd}$		-	2.2	-	
Gate charge total	$Q_g$	$V_{DD} = 350\text{V}$ , $I_D = 0.8\text{A}$ , $V_{GS} = 0\text{ to }10\text{V}$	-	3.9	5	
Gate plateau voltage	$V_{(plateau)}$	$V_{DD} = 350\text{V}$ , $I_D = 0.8\text{A}$	-	5.5	-	V

<sup>0</sup>J-STD20 and JESD22

<sup>1</sup>Repetitive avalanche causes additional power losses that can be calculated as  $P_{AV} = E_{AR} \cdot f$ .

<sup>2</sup>Device on 40mm\*40mm\*1.5mm epoxy PCB FR4 with 6cm<sup>2</sup> (one layer, 70 μm thick) copper area for drain connection. PCB is vertical without blown air.

<sup>3</sup> $I_{SD} \leq I_D$ ,  $di/dt \leq 400\text{A}/\mu\text{s}$ ,  $V_{DClink} = 400\text{V}$ ,  $V_{peak} < V_{BR, DSS}$ ,  $T_j < T_{j,max}$ .  
 Identical low-side and high-side switch.

**Electrical Characteristics**, at  $T_j = 25\text{ }^\circ\text{C}$ , unless otherwise specified

Parameter	Symbol	Conditions	Values			Unit
			min.	typ.	max.	
Inverse diode continuous forward current	$I_S$	$T_C=25^\circ\text{C}$	-	-	0.8	A
Inverse diode direct current, pulsed	$I_{SM}$		-	-	1.6	
Inverse diode forward voltage	$V_{SD}$	$V_{GS}=0\text{V}, I_F=I_S$	-	1	1.2	V
Reverse recovery time	$t_{rr}$	$V_R=350\text{V}, I_F=I_S,$	-	570	970	ns
Reverse recovery charge	$Q_{rr}$	$di_F/dt=100\text{A}/\mu\text{s}$	-	0.75	-	$\mu\text{C}$

**Typical Transient Thermal Characteristics**

Symbol	Value	Unit	Symbol	Value	Unit
	typ.			typ.	
Thermal resistance			Thermal capacitance		
$R_{th1}$	0.225	K/W	$C_{th1}$	0.00001221	Ws/K
$R_{th2}$	0.395		$C_{th2}$	0.00005037	
$R_{th3}$	0.603		$C_{th3}$	0.0000809	
$R_{th4}$	0.995		$C_{th4}$	0.0002915	
$R_{th5}$	0.691		$C_{th5}$	0.001844	
$R_{th6}$	0.148		$C_{th6}$	0.412	

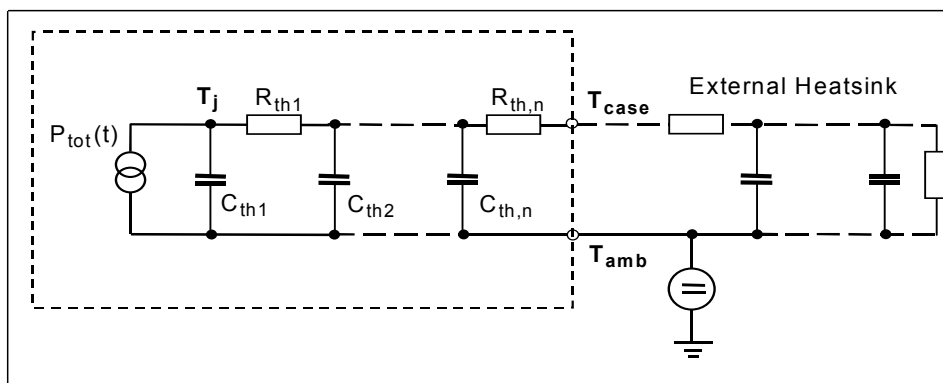

### 1 Power dissipation

$$P_{tot} = f(T_C)$$

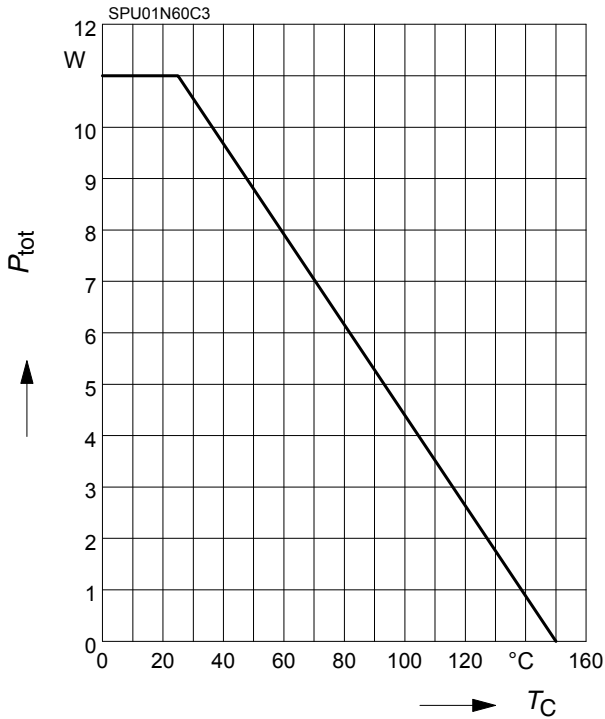

### 2 Safe operating area

$$I_D = f(V_{DS})$$

parameter :  $D = 0$  ,  $T_C = 25^\circ\text{C}$

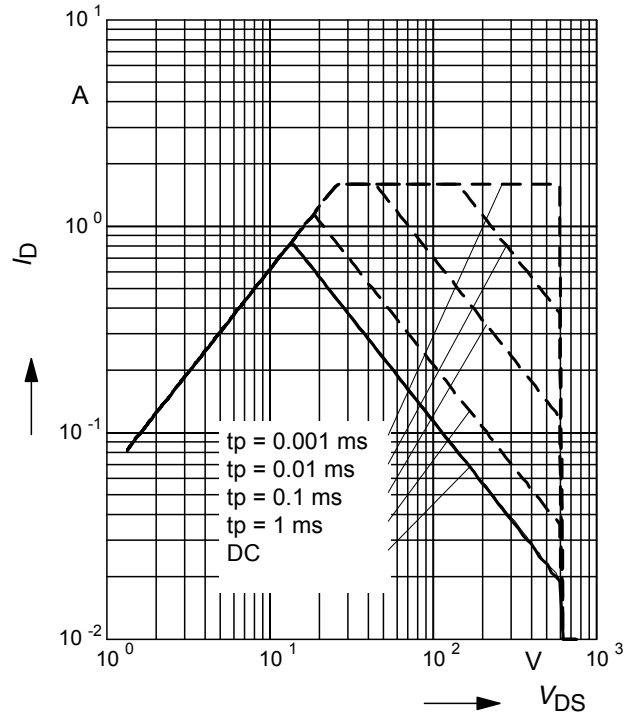

### 3 Transient thermal impedance

$$Z_{thJC} = f(t_p)$$

parameter:  $D = t_p/T$

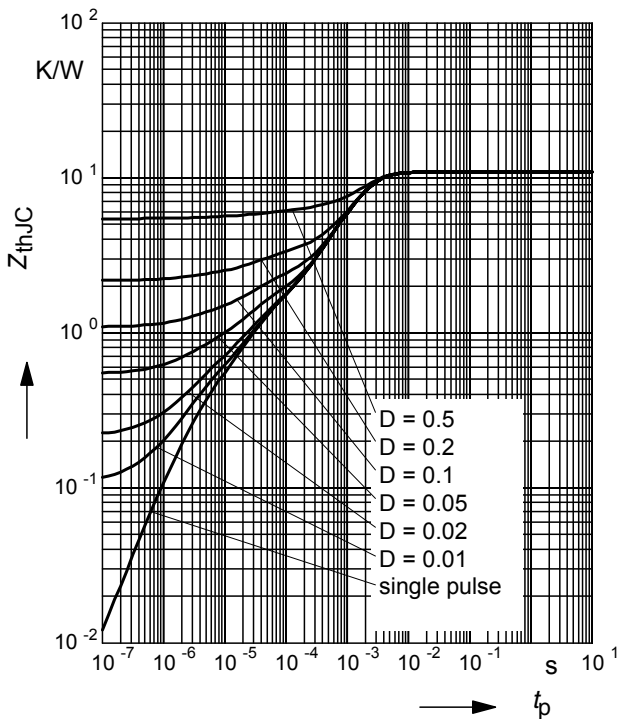

### 4 Typ. output characteristic

$$I_D = f(V_{DS}); T_j = 25^\circ\text{C}$$

parameter:  $t_p = 10 \mu\text{s}$  ,  $V_{GS}$

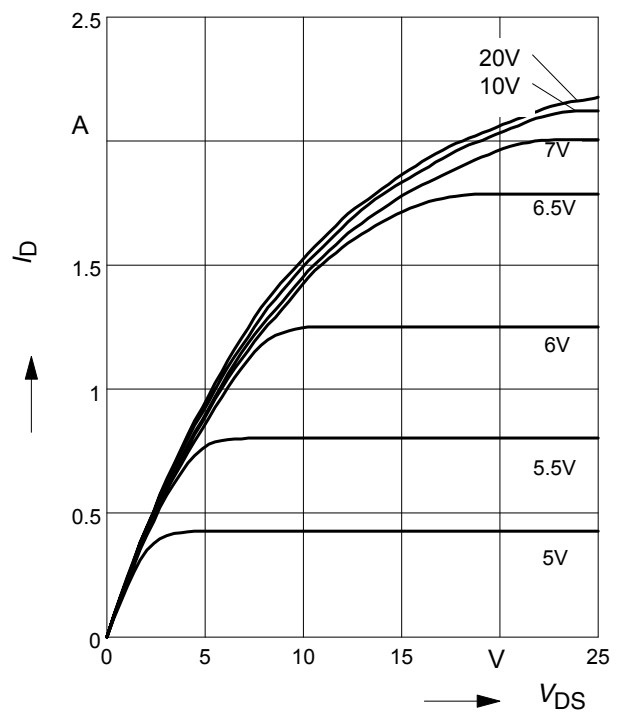

### 5 Drain-source on-state resistance

$$R_{DS(on)} = f(T_j)$$

parameter:  $I_D = 0.5 \text{ A}$ ,  $V_{GS} = 10 \text{ V}$

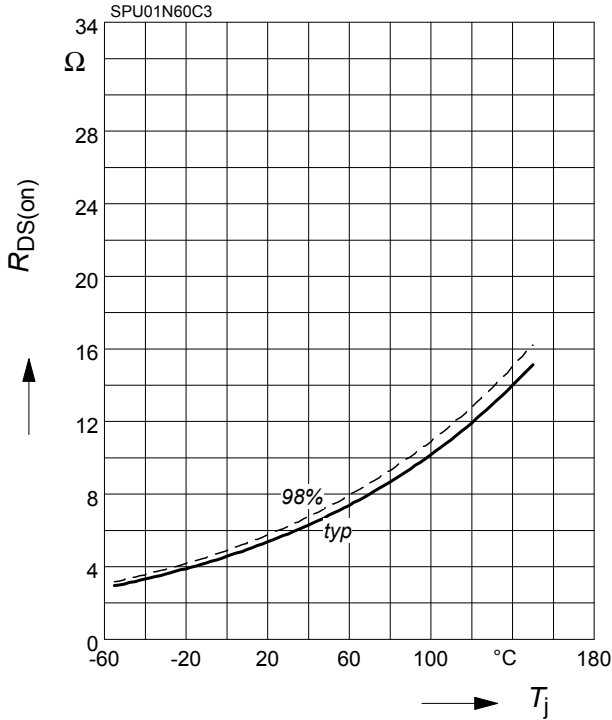

### 6 Typ. transfer characteristics

$$I_D = f(V_{GS}); V_{DS} \geq 2 \times I_D \times R_{DS(on)max}$$

parameter:  $t_p = 10 \mu\text{s}$

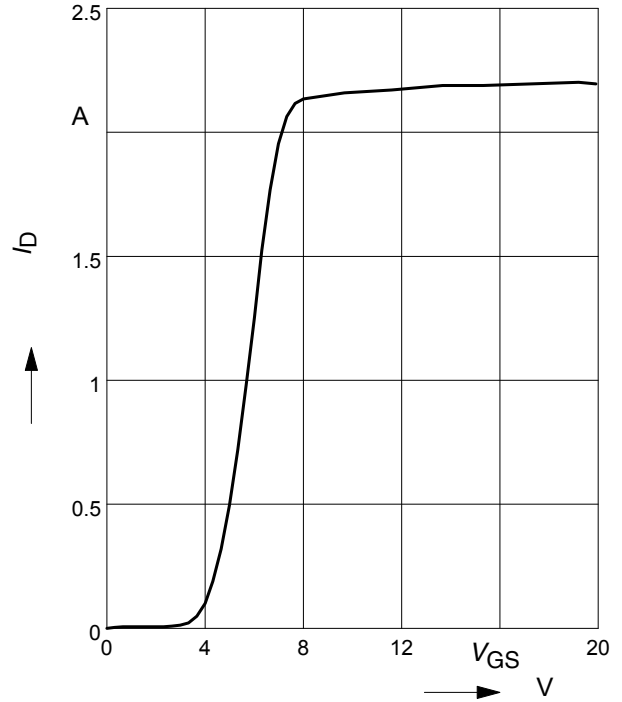

### 7 Typ. gate charge

$$V_{GS} = f(Q_{Gate})$$

parameter:  $I_D = 0.8 \text{ A}$  pulsed

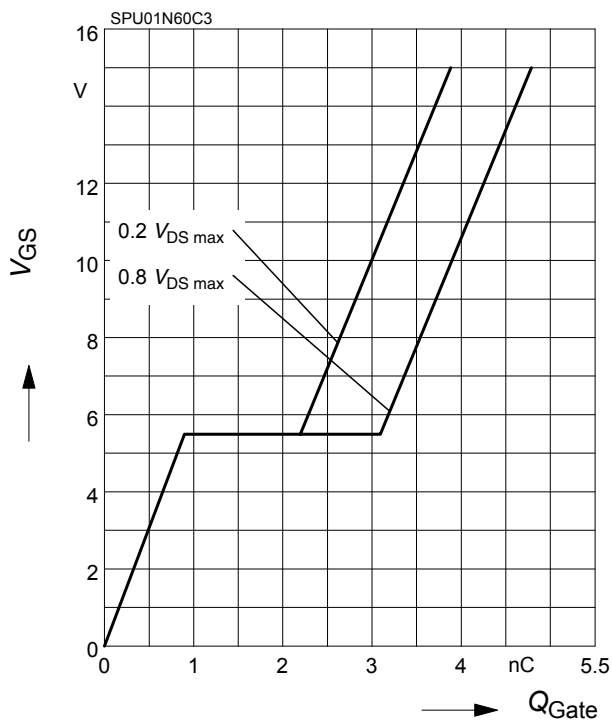

### 8 Forward characteristics of body diode

$$I_F = f(V_{SD})$$

parameter:  $T_j$ ,  $t_p = 10 \mu\text{s}$

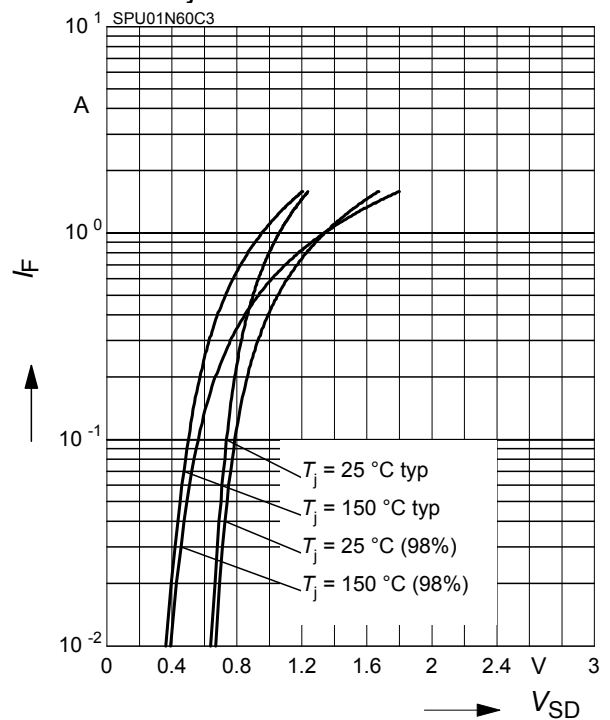

### 9 Avalanche SOA

$$I_{AR} = f(t_{AR})$$

par.:  $T_j \leq 150\text{ °C}$

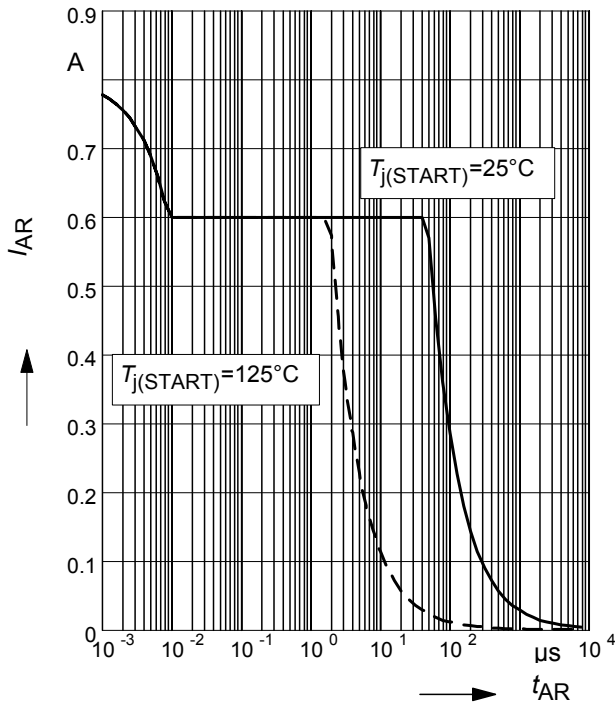

### 10 Avalanche energy

$$E_{AS} = f(T_j)$$

par.:  $I_D = 0.6\text{ A}$ ,  $V_{DD} = 50\text{ V}$

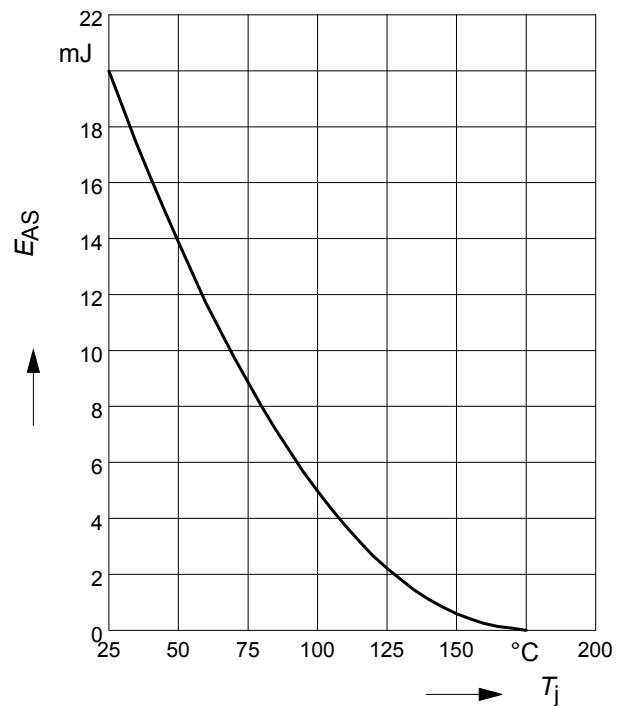

### 11 Drain-source breakdown voltage

$$V_{(BR)DSS} = f(T_j)$$

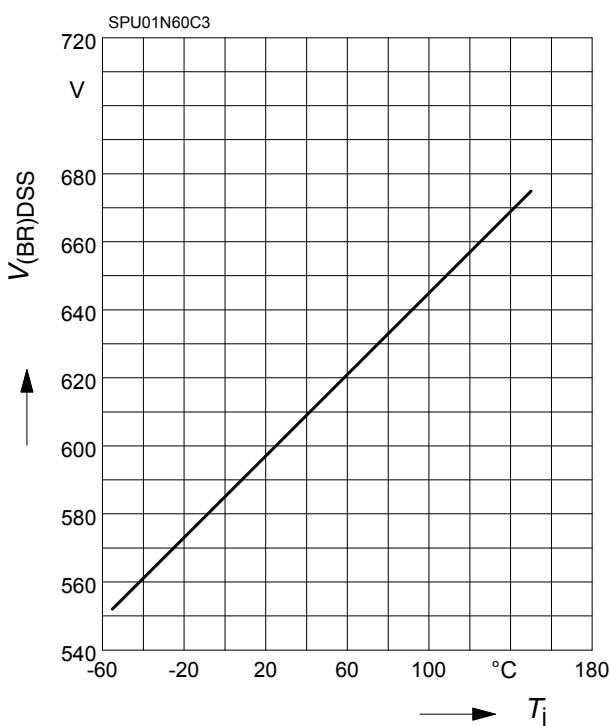

### 12 Typ. capacitances

$$C = f(V_{DS})$$

parameter:  $V_{GS} = 0\text{ V}$ ,  $f = 1\text{ MHz}$

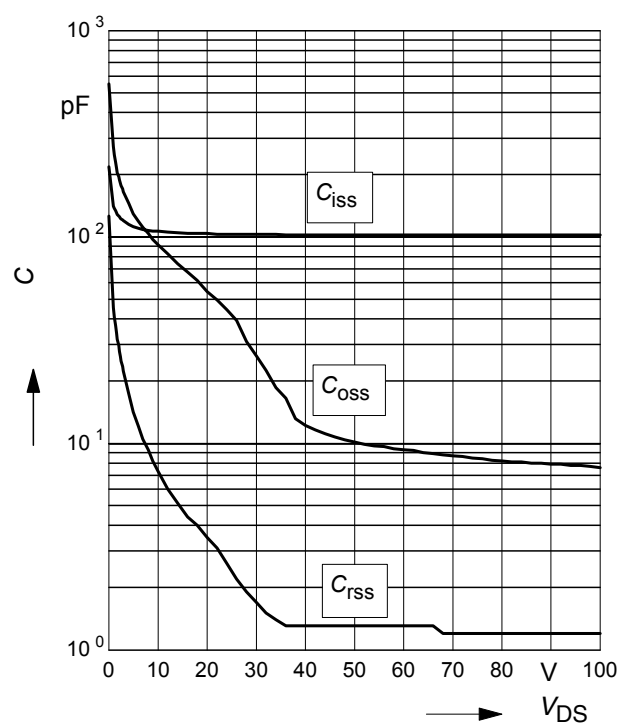

Definition of diodes switching characteristics





PG-TO-252-3-1 (D-PAK), PG-TO-252-3-11 (D-PAK), PG-TO-252-3-21 (D-PAK)

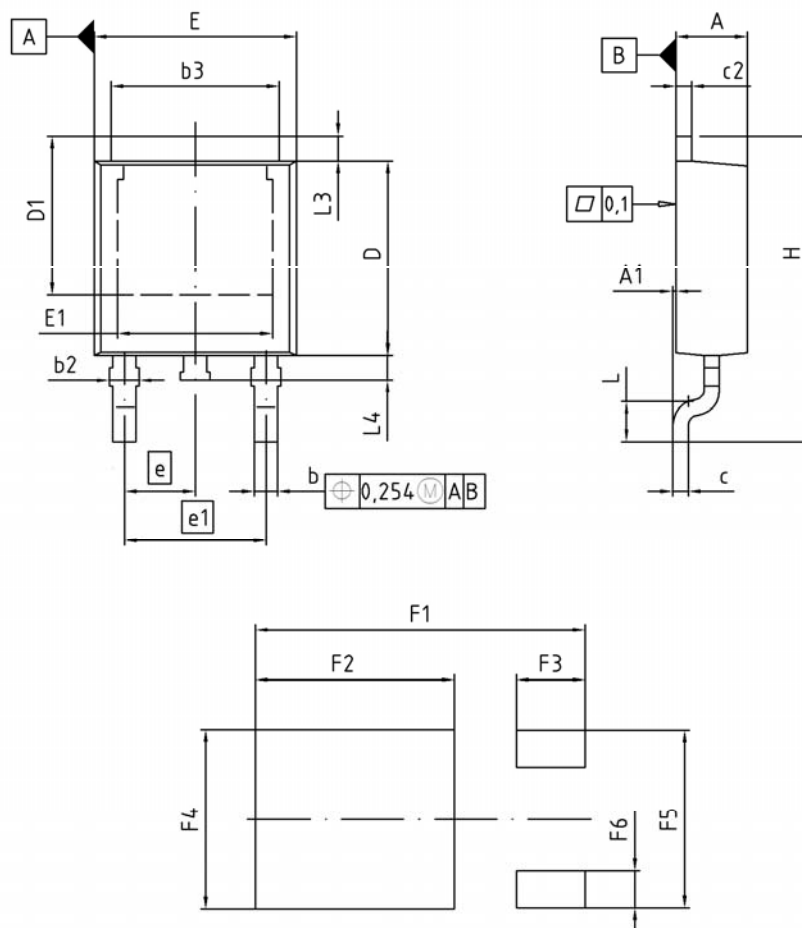

DIM	MILLIMETERS		INCHES	
	MIN	MAX	MIN	MAX
A	2.16	2.41	0.085	0.095
A1	0.00	0.15	0.000	0.006
b	0.64	0.89	0.025	0.035
b2	0.65	1.15	0.026	0.045
b3	5.00	5.50	0.197	0.217
c	0.46	0.60	0.018	0.024
c2	0.46	0.98	0.018	0.039
D	5.97	6.22	0.235	0.245
D1	5.02	5.84	0.198	0.230
E	6.40	6.73	0.252	0.265
E1	4.70	5.21	0.185	0.205
e	2.29		0.090	
e1	4.57		0.180	
N	3		3	
H	9.40	10.48	0.370	0.413
L	1.18	1.70	0.046	0.067
L3	0.90	1.25	0.035	0.049
L4	0.51	1.00	0.020	0.039
F1	10.50	10.70	0.413	0.421
F2	6.30	6.50	0.248	0.256
F3	2.10	2.30	0.083	0.091
F4	5.70	5.90	0.224	0.232
F5	5.66	5.86	0.223	0.231
F6	1.10	1.30	0.043	0.051

DOCUMENT NO.  
Z8B00003328

SCALE

EUROPEAN PROJECTION

ISSUE DATE  
19-10-2007

REVISION  
03

PG-TO-251-3-1 (I-PAK), PG-TO-251-3-21 (I-PAK)

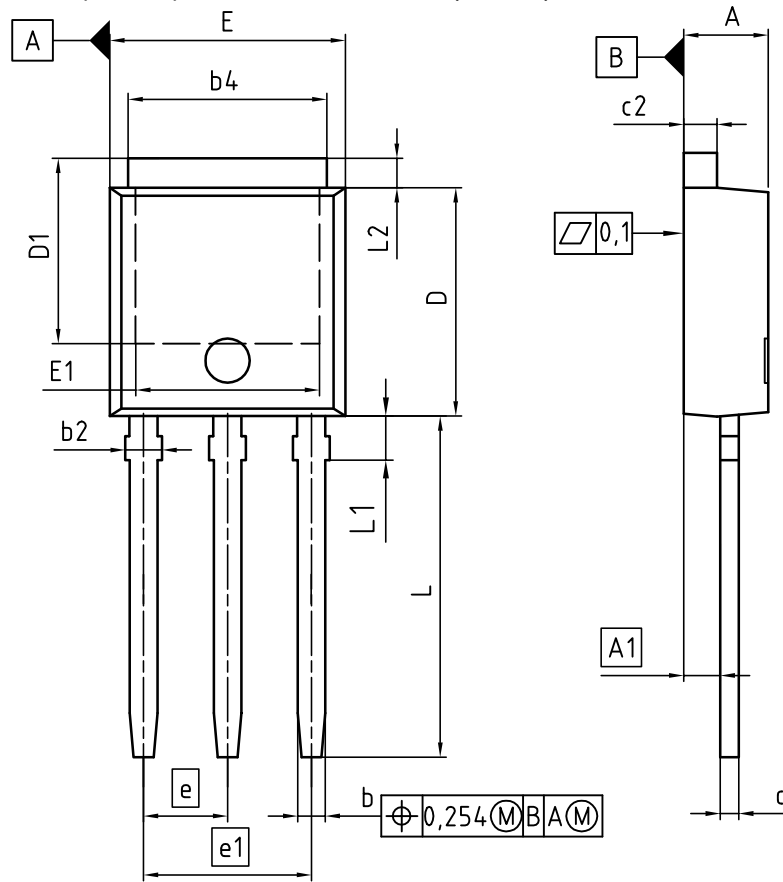

DIM	MILLIMETERS		INCHES	
	MIN	MAX	MIN	MAX
A	2.16	2.41	0.085	0.095
A1	0.90	1.14	0.035	0.045
b	0.64	0.89	0.025	0.035
b2	0.65	1.15	0.026	0.045
b4	4.95	5.50	0.195	0.217
c	0.46	0.60	0.018	0.024
c2	0.46	0.89	0.018	0.035
D	5.97	6.22	0.235	0.245
D1	5.04	5.77	0.198	0.227
E	6.35	6.73	0.250	0.265
E1	4.70	5.21	0.185	0.205
e	2.29		0.090	
e1	4.57		0.180	
N	3		3	
L	8.89	9.65	0.350	0.380
L1	1.90	2.29	0.075	0.090
L2	0.89	1.37	0.035	0.054

**DOCUMENT NO.**  
Z8B00003330

**SCALE**

**EUROPEAN PROJECTION**

**ISSUE DATE**  
19-03-2008

**REVISION**  
03

**Published by**  
**Infineon Technologies AG**  
**81726 Munich, Germany**  
**© 2008 Infineon Technologies AG**  
**All Rights Reserved.**

**Legal Disclaimer**

The information given in this document shall in no event be regarded as a guarantee of conditions or characteristics. With respect to any examples or hints given herein, any typical values stated herein and/or any information regarding the application of the device, Infineon Technologies hereby disclaims any and all warranties and liabilities of any kind, including without limitation, warranties of non-infringement of intellectual property rights of any third party.

**Information**

For further information on technology, delivery terms and conditions and prices, please contact the nearest Infineon Technologies Office ([www.infineon.com](http://www.infineon.com)).

**Warnings**

Due to technical requirements, components may contain dangerous substances. For information on the types in question, please contact the nearest Infineon Technologies Office. Infineon Technologies components may be used in life-support devices or systems only with the express written approval of Infineon Technologies, if a failure of such components can reasonably be expected to cause the failure of that life-support device or system or to affect the safety or effectiveness of that device or system. Life support devices or systems are intended to be implanted in the human body or to support and/or maintain and sustain and/or protect human life. If they fail, it is reasonable to assume that the health of the user or other persons may be endangered.