

Apr.1.2017 Copyright 2017 HIROSE ELECTRIC CO., LTD. All Rights Reserved.

COUNT	DESCRIPTION OF REVISIONS	BY	CHKD	DATE	COUNT	DESCRIPTION OF REVISIONS	BY	CHKD	DATE
△				..	△				..
△				..	△				..
△				..	△				..

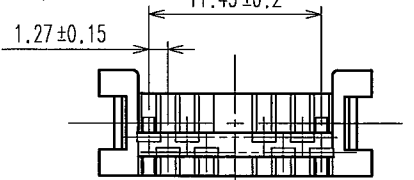
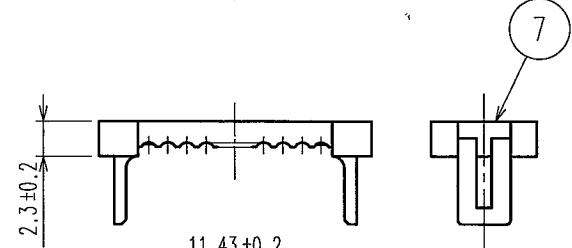
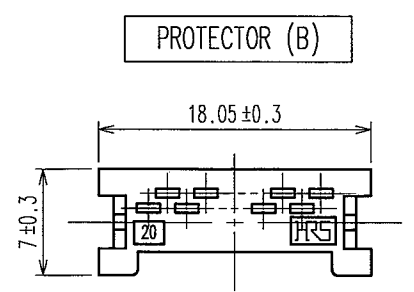
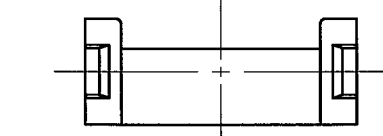
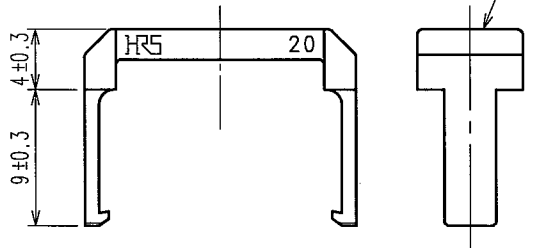
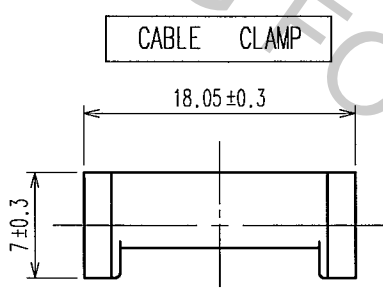
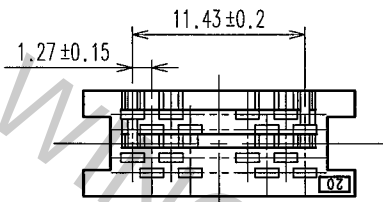
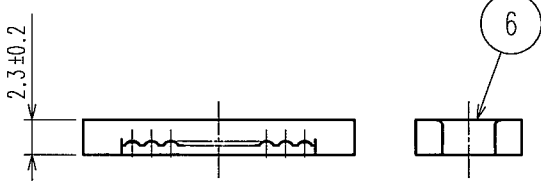
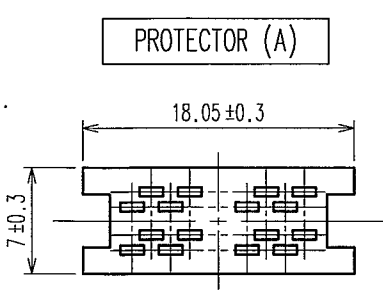
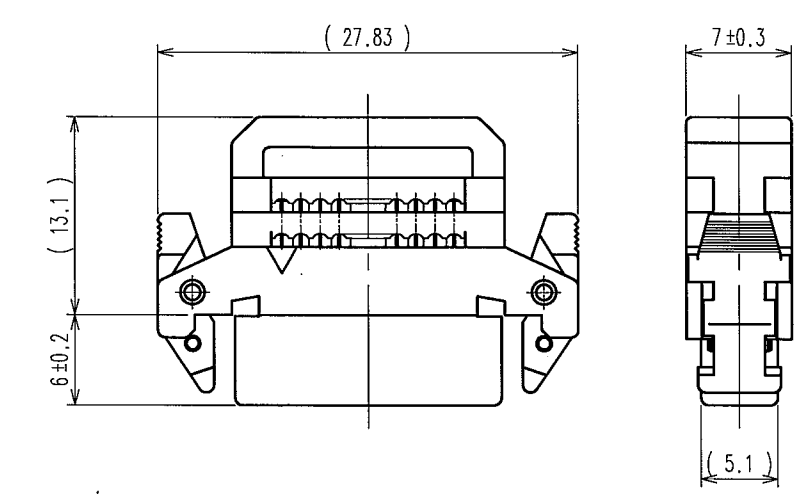
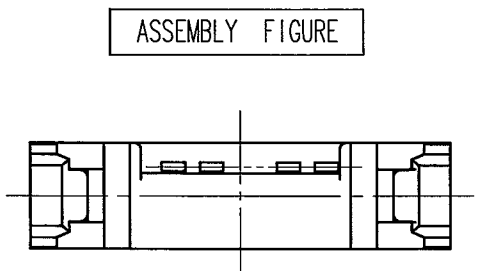
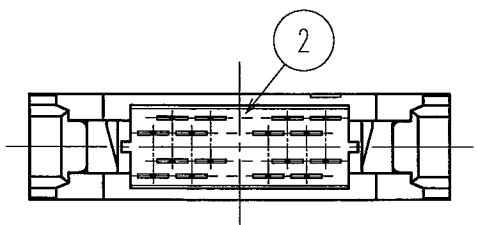
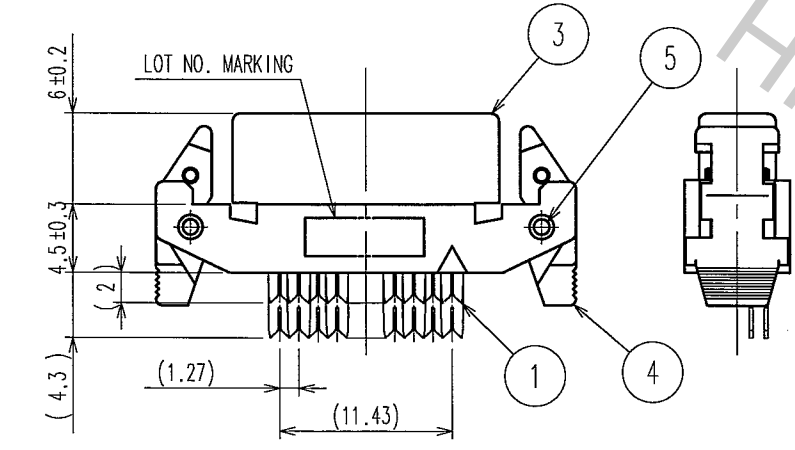
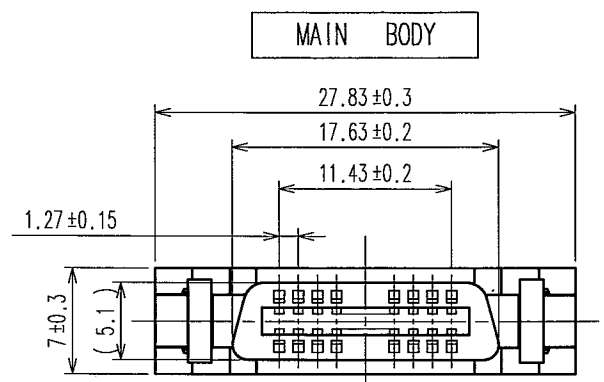

NOTE 1 COMPONENTS OF REF. NO.6~8 ARE APPENDED PRODUCTS.
2 THE DIMENSIONS IN PARENTHESES ARE FOR REFERENCE.

NO.	MATERIAL	FINISH, REMARKS
8	PA	BLACK UL94V-0
6,7	PBT	BLACK UL94V-0
5	STAINLESS STEEL	
2~4	PBT	BLACK UL94V-0
1	PHOSPHOR BRONZE	CONTACT AREA:GOLD FLASH UNDER PLATING:NICKEL 1μm min.

TO
PCK

CODE NO. (OLD) CL	DRAWN S.KAMGIA '07.10.31	DESIGNED S.KAMGIA '07.10.31	CHECKED <i>C. Ozawa</i> '07.11.02	APPROVED <i>H. Okawa</i> '07.11.02	RELEASED ..
SCALE 2:1	DRAWING NO. EDC3-151100		PART NO. FX2BM-20SA-1.27R		
UNITS mm	HRS HIROSE ELECTRIC CO., LTD		CODE NO. CL572-0631-6		1/1