

### Wireless charger transmitter evaluation board based on STWBC-WA for wearable applications

## Introduction

STEVAL-ISB038V1T is the wireless charger transmitter unit component of the STEVAL-ISB038V1 wireless charging reference design for wearable applications. It is based on the STWBC-WA and is designed to transfer up to 1 watt of power to wireless power to devices requiring the use of small coils. It can be modified to deliver up to 3 watts.

The STEVAL-ISB038V1 is a wireless battery charger reference design evaluation kit designed for ultra-compact battery operated devices, such as wearable gear, smartwatches, Internet of Things sensors and healthcare devices.

The design is optimized for 1-watt wireless power transfer with a half-bridge topology on the transmitter side and with tiny 11 mm and 20 mm coils on the receiver and transmitter sides, respectively. For power transfers up to 3 watts, the design can be modified by using larger coils and a full-bridge configuration on the transmitter.

The STWBC-WA transmitter can support a cost-effective half-bridge topology (full-bridge optional) and a powerful software API lets you modify the behavior of LED and general purpose IOs as well as connecting external peripherals or devices like sensors to the design via the on-chip I<sup>2</sup>C and UART ports.

The STWLC04 is designed for 1-watt power transfer based on the Qi protocol, with digital control and precise analog control loops ensuring stable operation. The I<sup>2</sup>C interface allows a high degree of customization and settings can be stored in the embedded non-volatile memory.

**Figure 1: STEVAL-ISB038V1T transmitter evaluation board**

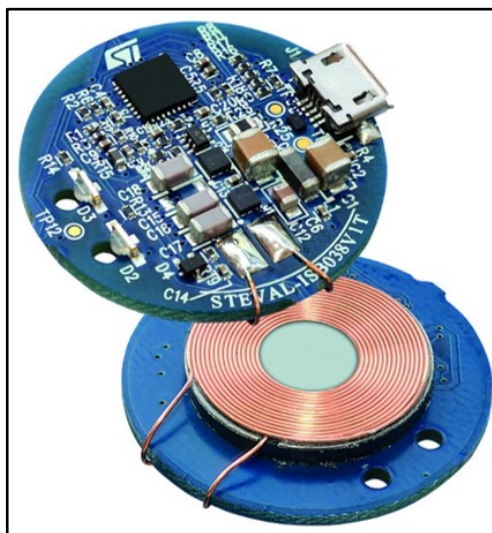

# Contents

<b>1</b>	<b>Getting started</b> .....	<b>5</b>
1.1	System requirements .....	5
1.2	Package contents.....	5
<b>2</b>	<b>Hardware description and setup</b> .....	<b>6</b>
2.1	System block diagram.....	6
2.2	STEVAL-ISB038V1T wireless transmitter board .....	6
2.3	STWBC-WA pinout and pin description .....	10
<b>3</b>	<b>Download procedure</b> .....	<b>12</b>
3.1	STWBC GUI software installation .....	12
3.2	Firmware download with STWBC GUI .....	12
3.2.1	Download procedure with a new chip (never programmed).....	13
3.2.2	Firmware upgrade procedure (chip already programmed).....	15
3.3	Erasing firmware procedure using STVP .....	16
3.3.1	Requirements .....	16
3.3.2	Procedure .....	16
3.4	Firmware download via UART using the command line interface ...	20
3.4.1	With written chip .....	20
3.4.2	With blank chip .....	20
3.5	STVP file creation to download with STVP .....	20
3.6	Firmware download with STVP .....	22
<b>4</b>	<b>Setting up the evaluation equipment</b> .....	<b>24</b>
<b>5</b>	<b>GUI and evaluation procedure</b> .....	<b>25</b>
5.1	Status LEDs .....	31
<b>6</b>	<b>Schematic diagrams</b> .....	<b>32</b>
<b>7</b>	<b>Transmitter bill of materials</b> .....	<b>35</b>
<b>8</b>	<b>Transmitter board assembly and layout</b> .....	<b>39</b>
8.1	Design considerations.....	39
8.1.1	Power signals (5V, GND and LC power node).....	39
8.1.2	Sensitive signals.....	40
<b>9</b>	<b>References</b> .....	<b>42</b>
<b>10</b>	<b>Revision history</b> .....	<b>43</b>

---

## List of tables

Table 1: STEVAL-ISB038V1T electrical performance.....	7
Table 2: Connector description.....	9
Table 3: Test points.....	9
Table 4: Pinout description.....	10
Table 5: SWIM connector details on ST-LINK programmer.....	18
Table 6: STEVAL-ISB038V1T board bill of materials.....	35
Table 7: Document revision history.....	43

## List of figures

Figure 1: STEVAL-ISB038V1T transmitter evaluation board .....	1
Figure 2: Block diagram .....	6
Figure 3: STEVAL-ISB038V1T evaluation board with SWIM connector .....	7
Figure 4: Board silkscreen top layer .....	8
Figure 5: Board silkscreen bottom layer .....	9
Figure 6: STWBC-WA pin configuration .....	10
Figure 7: STWC Qi GUI start screen .....	12
Figure 8: PC to USB-to-UART dongle connection.....	13
Figure 9: Firmware download with STWBC Qi GUI.....	14
Figure 10: USB-to-UART dongle to STEVAL-ISB038V1T transmitter board connection.....	15
Figure 11: Firmware download progress window .....	15
Figure 12: Configuration of STVP .....	16
Figure 13: ST-LINK connection on the board .....	17
Figure 14: SWIM wired connection.....	18
Figure 15: STVP core selection .....	18
Figure 16: STVP download .....	19
Figure 17: STVP wrong device selected alert .....	19
Figure 18: STVP incompatible device action query .....	19
Figure 19: Command line .....	20
Figure 20: Command line with blank chip.....	20
Figure 21: STWBC Convert CAB to STVP menu selection .....	21
Figure 22: Selecting cab file to convert.....	21
Figure 23: Generated STVP project files .....	22
Figure 24: Transmitter – receiver test setup.....	24
Figure 25: Transmitter – receiver setup with UART cable.....	24
Figure 26: STWBC Qi transmission status information .....	25
Figure 27: STWBC Qi Protocol window .....	26
Figure 28: STWBC Qi Monitor window .....	26
Figure 29: STWBC Qi Parameters window .....	28
Figure 30: STWBC Qi parameter modification (Push to target) .....	29
Figure 31: STWBC Qi saving modified parameters (Dump to bin.).....	30
Figure 32: STWBC Qi updating firmware with new parameters .....	31
Figure 33: STEVAL-ISB038V1T transmitter control stage .....	32
Figure 34: STEVAL-ISB038V1T transmitter power stage .....	33
Figure 35: STEVAL-ISB038V1T USB to UART dongle .....	34
Figure 36: STEVAL-ISB038V1T evaluation board functional blocks.....	39
Figure 37: STEVAL-ISB038V1T power signal layout .....	40
Figure 38: Isense and wave_sns analog input signals routing .....	41
Figure 39: UART signals and switching signals driving the bridge.....	41

# 1 Getting started

## 1.1 System requirements

The GUI for the STEVAL-ISB038V1T board requires Microsoft Windows XP® or later plus NET Framework 4. The PC and the board are connected with a USB-to-UART cable.

## 1.2 Package contents

To evaluate the STEVAL-ISB038V1T board, ensure you have:

- Hardware:
  - STEVAL-ISB038V1T board
  - ST-LINK/V2 in-circuit debugger/programmer with single wire interface module (SWIM) available for download from [www.st.com](http://www.st.com)
  - USB to UART interface cable with micro-USB connection in order to use the GUI and to supply the board.
- Software:
  - ST-LINK USB driver
  - STVP programming tool from STMicroelectronics (integrated into STVD tools)
  - FTDI VCP driver <http://www.ftdichip.com/Drivers/VCP.htm>
  - PC GUI installation package

## 2 Hardware description and setup

### 2.1 System block diagram

Figure 2: Block diagram

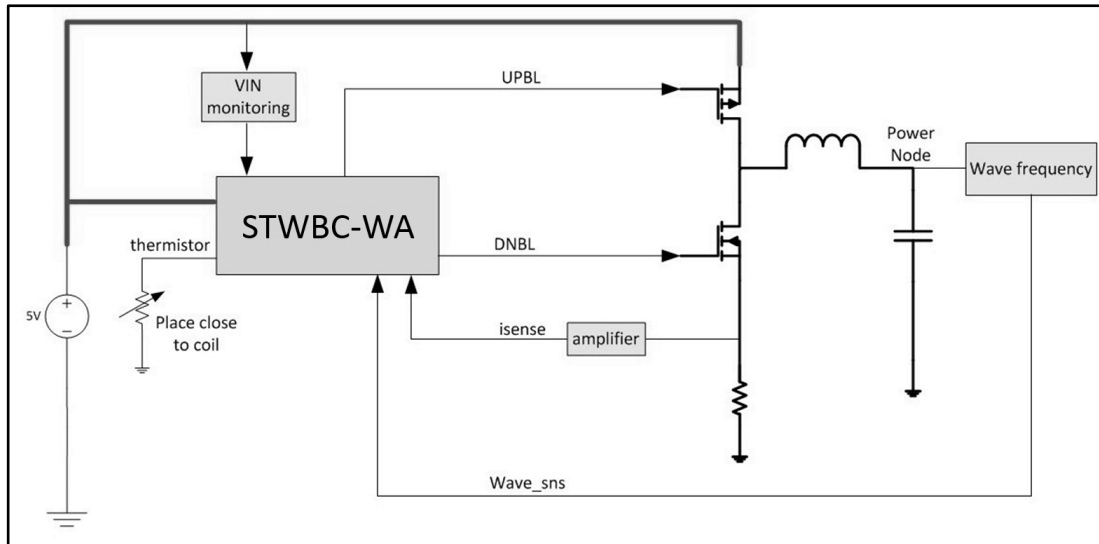

### 2.2 STEVAL-USB038V1T wireless transmitter board

The STEVAL-USB038V1T board features:

- STWBC-WA based wireless power transmitter
  - Additional transmitter module compatible with the STEVAL-USB038V1 reference kit
  - Cost effective Half Bridge topology with integrated drivers
  - Optional Full Bridge configuration for 3 W applications
  - Active presence detector
  - 2-layer PCB for easy design
  - Turnkey solution or customizable via APIs
  - Parametric customization via graphical interface
- Full KIT characteristics:
  - 11 mm coil on Receiver
  - 20 mm coil on Transmitter
  - 1 Watt delivered on Receiver side
  - USB 5 V input
  - Foreign Object Detection (FOD) optional
  - Graphical interface for monitoring behavior
  - Total reference design
  - RoHS compliant
- STWLC04 wireless power receiver
  - Output voltage: 5 V regulated voltage
  - Integrated high efficiency synchronous rectifier
  - Li-Ion/Li-Pol charger functionality
  - 4-layer PCB for easy design

Table 1: STEVAL-ISB038V1T electrical performance

Parameter	Description	Notes and conditions	Min.	Typ.	Max.	Unit
Input characteristics						
V <sub>in</sub>	Input Voltage		4.75	5	5.5	V
I <sub>in</sub>	Input current	V <sub>in</sub> nominal, I <sub>out</sub> = Max		0.4	0.6	A
	Input No-load current					mA
	Input Standby current					mA
System characteristics						
FS	Switching frequency	decrease with load	110		205	kHz
η	Full load efficiency	V <sub>in</sub> = 5 V, R <sub>X_Power</sub> = 1 W		50 <sup>(1)</sup>		%

Notes:

<sup>(1)</sup>Efficiency data related to the use of the 15mm TDK coil (WT151512-22F2)

Figure 3: STEVAL-ISB038V1T evaluation board with SWIM connector

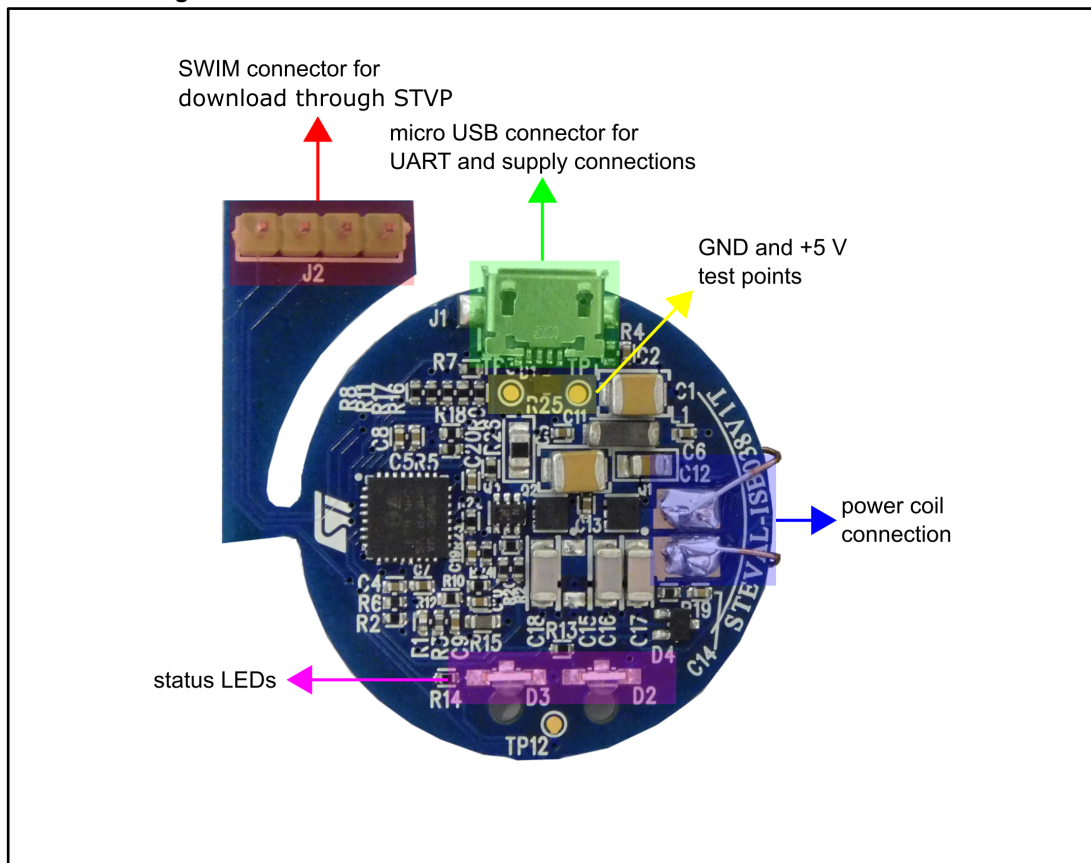





Figure 5: Board silkscreen bottom layer

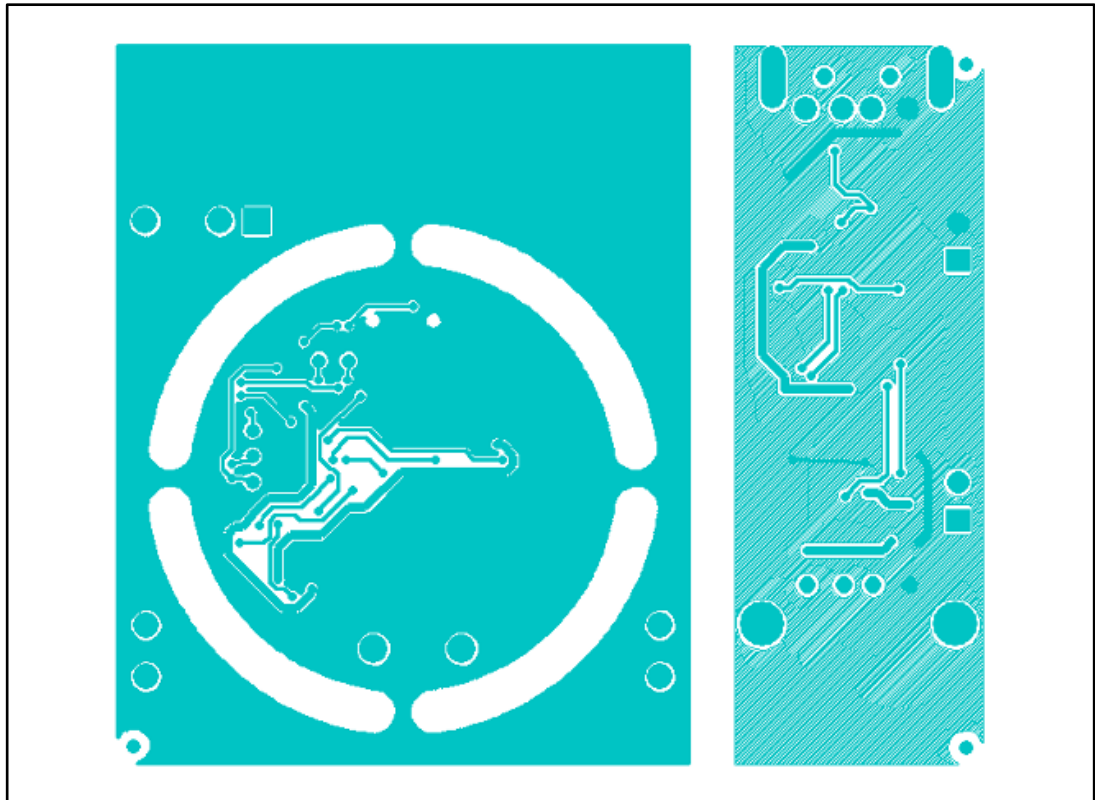

Table 2: Connector description

connector reference	Description
J1	USB to UART connector for GUI and board supply
J2	SWIM connector for the download
J3	VBUS/external power supply connection
J4	VBUS/GND connection
J5	USB male connector
J6	USB female connector

Table 3: Test points

Test point reference	Signal	Description
TP1	+5 V	5 V input voltage
TP2	USB_DM	USB signal
TP3	GND	Ground
TP4	USB_DP	USB signal
TP5	PWM_AUX/GPIO_2	PWM output or GPO
TP6	UART_TX	UART Tx signal
TP7	UART_RX	UART Rx signal
TP8	WAVE_SNS	Comparator 0 input for symbol detection
TP9	LEDR	LED Red signal

Test point reference	Signal	Description
TP10	LEDG	LED Green signal
TP11	ISENSE	ADC input for current measurement
TP12	GND	Ground

### 2.3 STWBC-WA pinout and pin description

Figure 6: STWBC-WA pin configuration

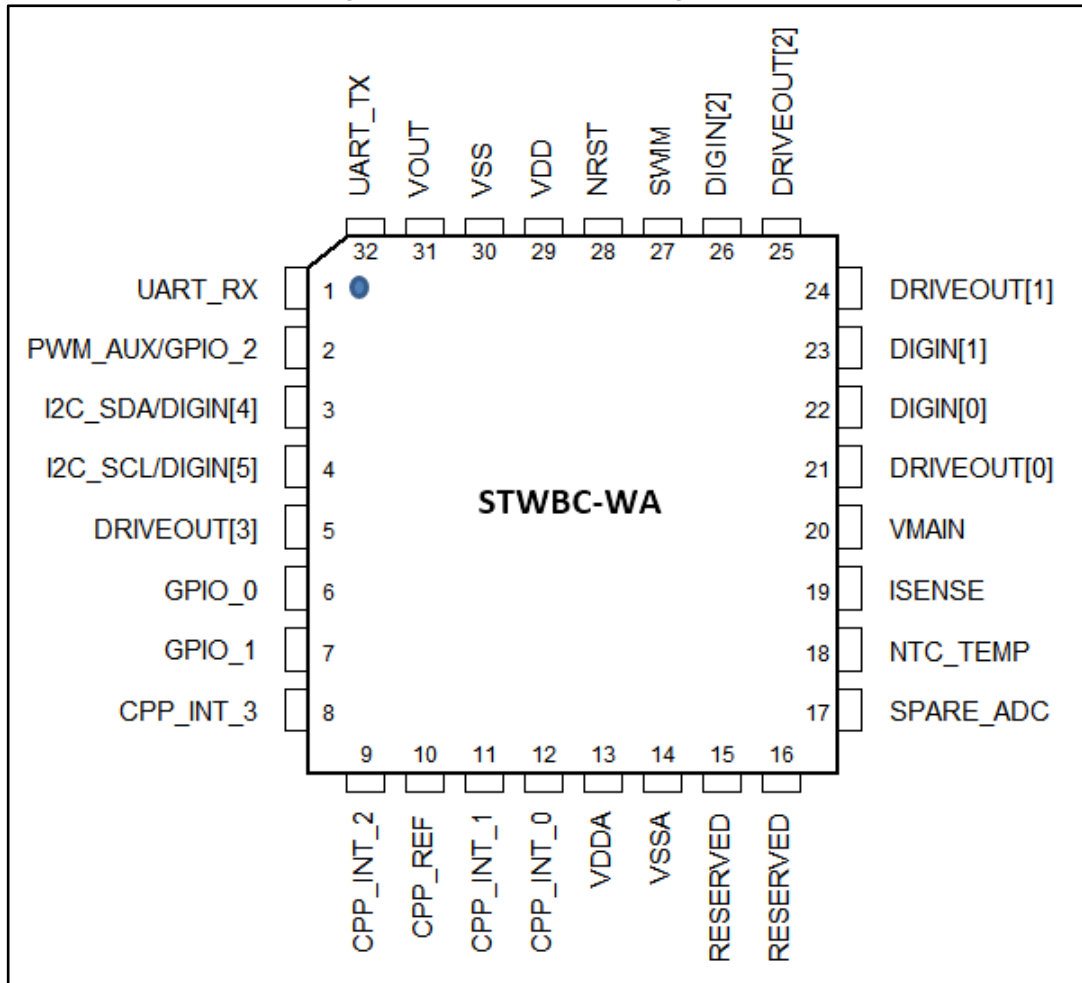

Table 4: Pinout description

Pin number	Pin name	Pin type	Turnkey firmware description
1	UART_RX <sup>(1)</sup>	DI	Uart RX link
2	PWM_AUX/GPIO_2 <sup>(1)</sup>	DO	Not used, must not be connected to any potential
3	I2C_SDA/DIGIN[4] <sup>(1)</sup>		inactive (internal pull up)
4	I2C_SCL/DIGIN[5] <sup>(1)</sup>		inactive (internal pull up)
5	DRIVEOUT[3]	DO	Output driver for Full Bridge configuration (optional)
6	GPIO_0 <sup>(1)</sup>	DO	Digital output for the green light indicator

Pin number	Pin name	Pin type	Turnkey firmware description
7	GPIO_1 <sup>(1)</sup>	DO	Digital output for the red light indicator
8	CPP_INT_3	AI	Connected to GND
9	CPP_INT_2	AI	Connected to GND
10	CPP_REF	AI	External reference for CPP_INT_3 (if not used, must be tied to GND)
11	CPP_INT_1	AI	Connected to GND
12	CPP_INT_0	AI	Wave_sns signal for symbol detection
13	VDDA	PS	Analog power supply
14	VSSA	PS	Analog ground
15	RESERVED	AI	Reserved
16	RESERVED		Reserved
17	SPARE_ADC <sup>(1)</sup>		Connected to USB_ID signal
18	NTC_TEMP	AI	NTC temperature measurement.
19	ISENSE	AI	LC Tank Current measurement
20	VMAIN	AI	Vmain Monitor
21	DRIVEOUT[0]	DO	Output driver for Low side branch
22	DIGIN[0] <sup>(1)</sup>		inactive (internal pull up)
23	DIGIN[1] <sup>(1)</sup>		inactive (internal pull up)
24	DRIVEOUT[1]	DO	Output driver for high side branch
25	DRIVEOUT[2]	DO	Output driver for Full Bridge configuration (optional)
26	DIGIN[2] <sup>(1)</sup>		Not connected
27	SWIM	DIO	Debug interface
28	NRST	DI	Reset
29	VDD	PS	Digital and I/O Power supply
30	VSS	PS	Digital and I/O Ground
31	VOUT	Supply	Internal LDO output
32	UART_TX <sup>(1)</sup>	DO	Uart TX link

**Notes:**

<sup>(1)</sup>This pin behavior can be configured via API



All analog inputs are VDD compliant, but only between 0 and 1.2 V can be used

## 3 Download procedure

The firmware can only be downloaded to the board via the GUI software, which also provides comprehensive board monitoring features.

### 3.1 STWBC GUI software installation

- 1 Install the GUI by launching the STWBC\_GUI\_Setup.msi installer file.
- 2 Connect the wireless power transmitter board to the PC with a USB-to-UART cable.
- 3 Select the appropriate USB serial Com port. You can check Windows Device Manager to identify the correct port number. If the com port is not listed in the selection window, enter it in the Special textbox (e.g., "COM12").

Figure 7: STWC Qi GUI start screen

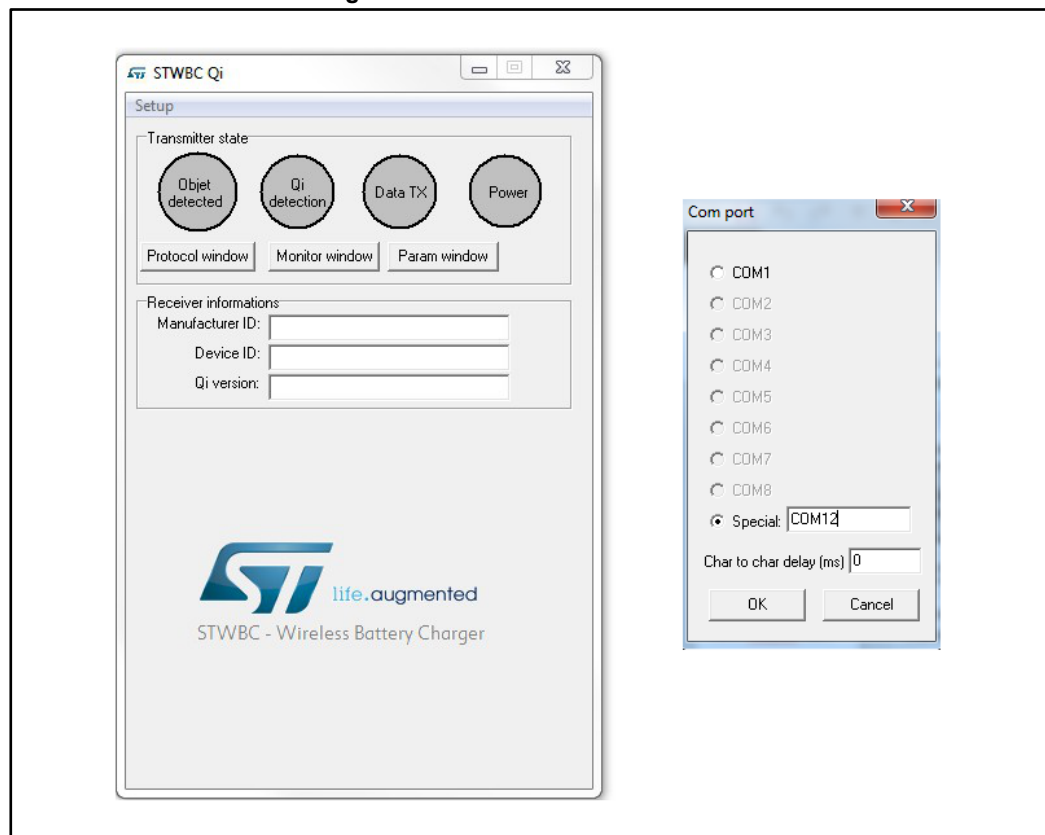

- 4 Press "OK"  
The GUI is ready to run.

### 3.2 Firmware download with STWBC GUI

The GUI lets you download firmware via UART. The download contains three files incorporated in a single cab file.

### 3.2.1 Download procedure with a new chip (never programmed)

If the chip has never been programmed (i.e., a new chip from STMicroelectronics), download mode is enabled by default.

- 1 Connect the USB to UART dongle to the computer. Do not connect the transmitter board for the moment.

**Figure 8: PC to USB-to-UART dongle connection**

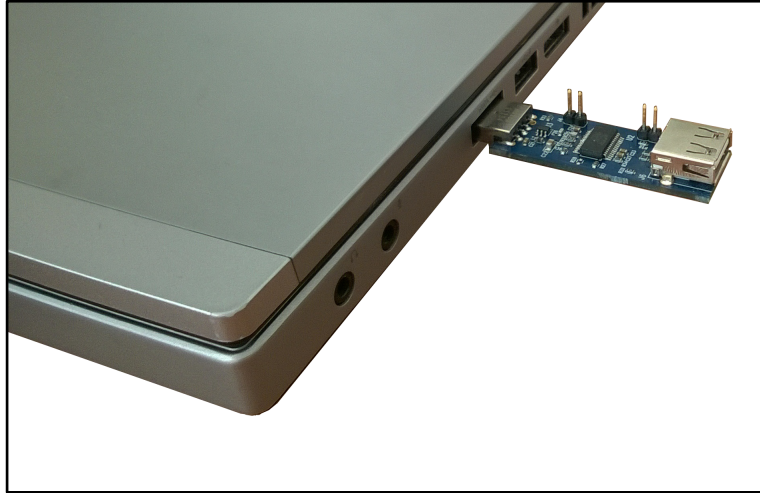

- From the STWBC Qi GUI, select Load FW to board from the Setup menu.

**Figure 9: Firmware download with STWBC Qi G**

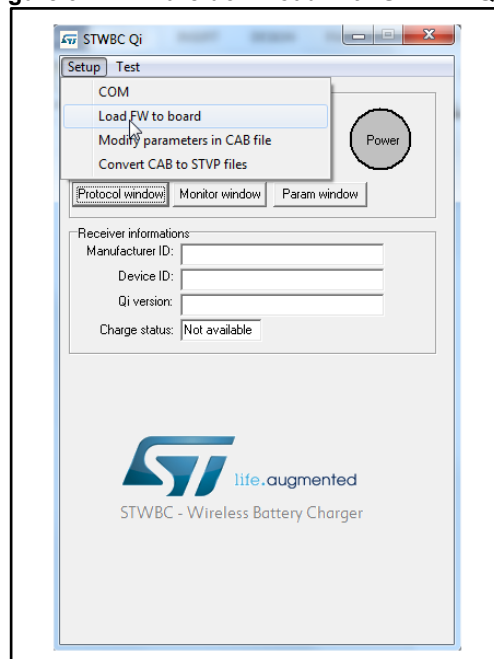

- As prompted, select the CAB file containing the Firmware to download.
- As prompted, Power on the board and keep it powered.

- 5 When the DOS window appears, connect the transmitter board to the dongle with a micro-USB cable.

**Figure 10: USB-to-UART dongle to STEVAL-ISB038V1T transmitter board connection**



- 6 You can follow the download progress in the DOS window. Power off the board when prompted.

**Figure 11: Firmware download progress window**



### 3.2.2 Firmware upgrade procedure (chip already programmed)

If a chip has already been programmed with firmware, the download mode is disabled and special command needs to be sent to STWBC-WA to enable the download mode.

- 1 Connect the transmitter board to the USB to UART dongle; the transmitter board is powered through this dongle. The UART RX/TX signals of the STWBC-WA are accessible on the micro-USB connector of the transmitter board (USB\_DP and USB\_DM, respectively).  
see [Figure 10: "USB-to-UART dongle to STEVAL-ISB038V1T transmitter board connection"](#)
- 2 From the STWBC Qi GUI, select Load FW to board from the Setup menu.  
see [Figure 9: "Firmware download with STWBC Qi GUI"](#)

- 3 As prompted, select the CAB file containing the Firmware to download.
- 4 As prompted, Power on the board and keep it powered.
- 5 You can follow the download progress in the DOS window. Power off the board when prompted.  
see [Figure 11: "Firmware download progress window"](#)
- 6 See [Section 3.3: "Erasing firmware procedure using STVP"](#) if you encounter problems during firmware download via UART.

### 3.3 Erasing firmware procedure using STVP

The firmware can be erased using STVP if you are having problems such as firmware corruption during update.

#### 3.3.1 Requirements

- ST-LINK USB driver installed.
- STVP programming tool from STMicroelectronics installed.
- ST-LINK hardware tools
- STVP configuration as per the following figure.

Figure 12: Configuration of STVP

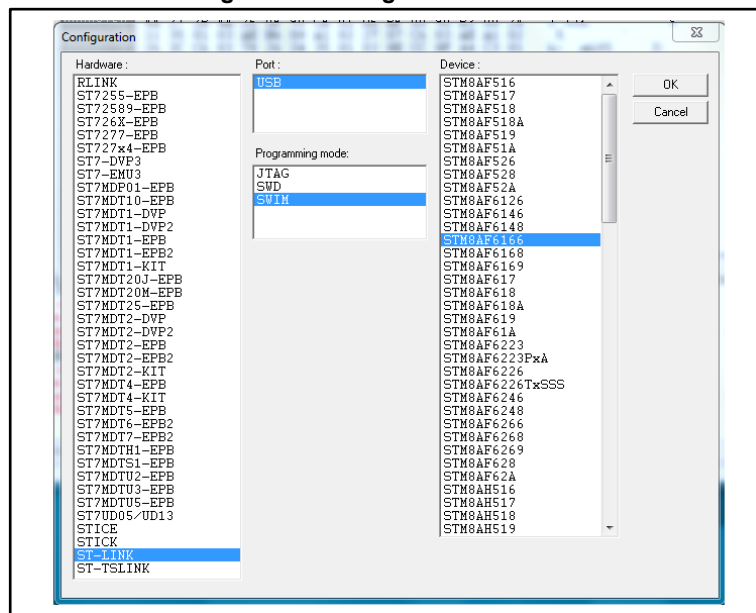

#### 3.3.2 Procedure

- 1 Target power off
- 2 Target power on using a micro-USB cable to supply the board
- 3 ST-LINK circuit connected to the computer by USB



- 4 Connect ST-LINK – SWIM cable with target. Pay special attention to connect the SWIM cable to the transmitter board correctly (white strip towards the bottom).

Figure 13: ST-LINK connection on the board

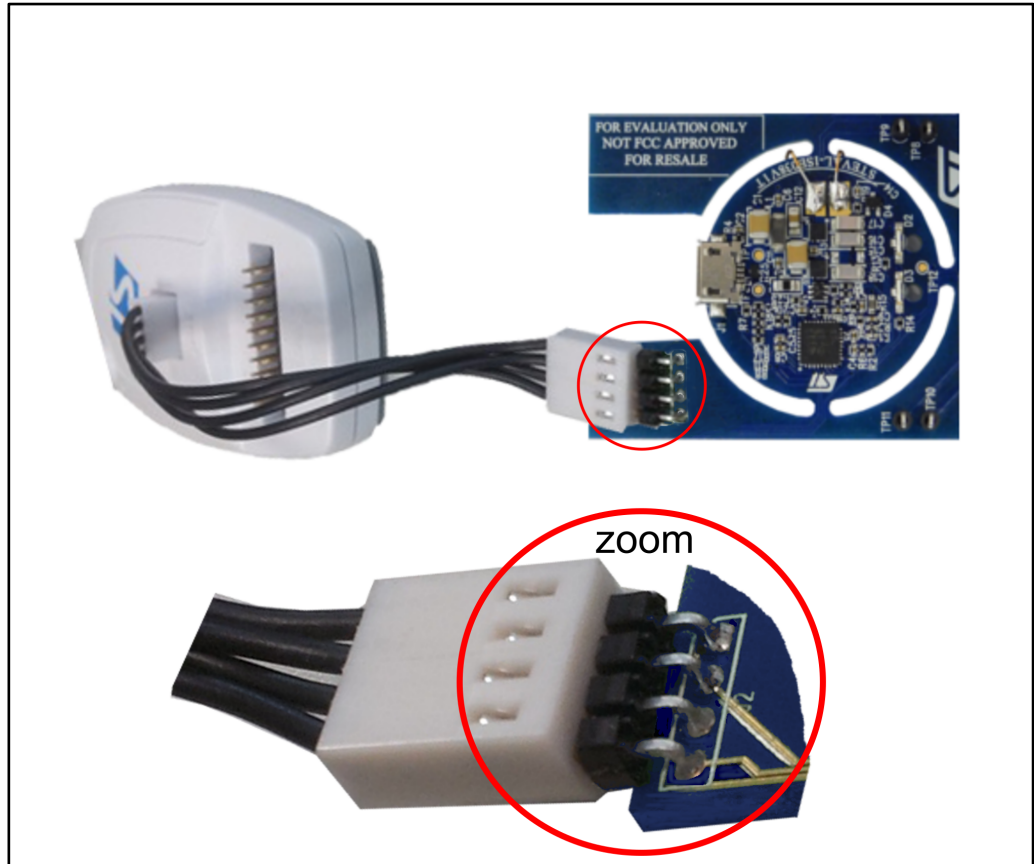

- 5 If the debug section of the board with the SWIM connector has been removed, you can wire the SWIM, RESET and VDD\_STWBC signals from R18, R5 and C5, respectively. GND can be connected on the right hand side of C1.

**Figure 14: SWIM wired connection**

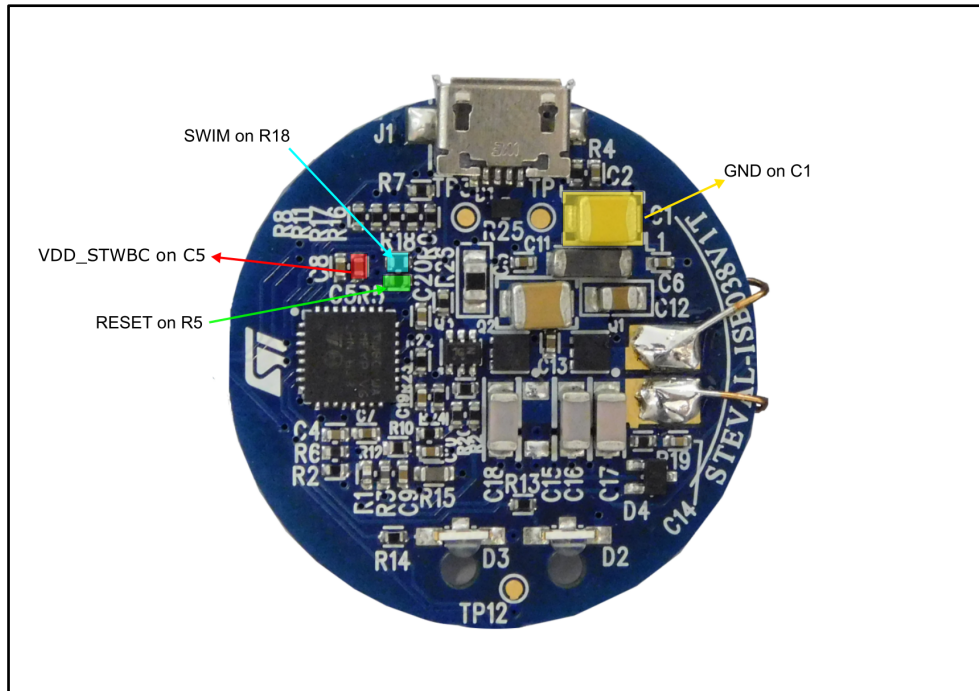

indicated below.

**Figure 16: STVP download**

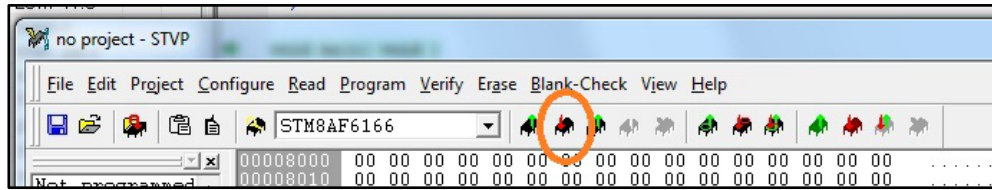

- 10 Click OK if a “Wrong device selected” alert appears.

**Figure 17: STVP wrong device selected alert**

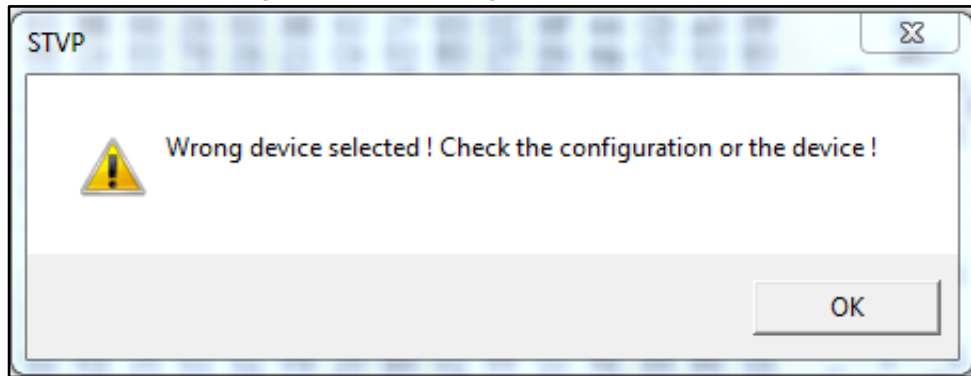

- 11 Click YES if “An incompatibility has been found with this device” query appears.

**Figure 18: STVP incompatible device action query**

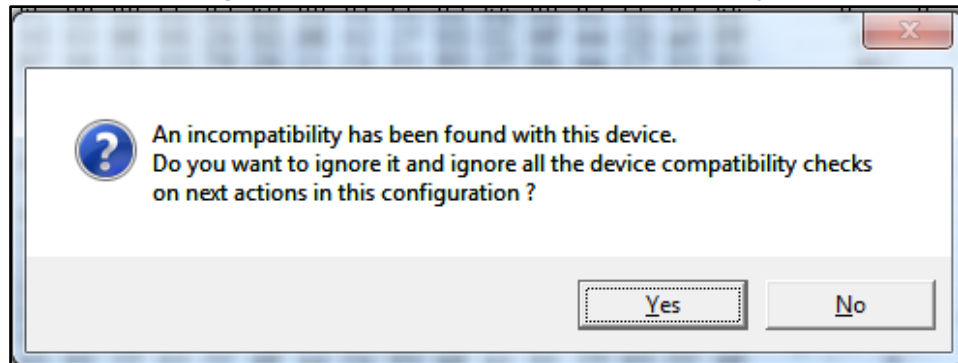

- 12 On completion of the programming procedure starts, the STVP informs the user that the program is loaded and verified.

```
< PROGRAM MEMORY programming completed.
> Verifying PROGRAM MEMORY area...
< PROGRAM MEMORY successfully verified.
```

- 13 Exit STVP.
- 14 Disconnect SWIM.
- 15 Remove power from the STEVAL-ISB038V1T board.
- 16 Retry the UART download procedure if necessary.

### 3.4 Firmware download via UART using the command line interface

#### 3.4.1 With written chip

- 1 Ensure a dedicated directory has the following files:
  - a. STWBC\_Loader.exe
  - b. stwbc\_loader\_not\_empty.bat
  - c. enable\_boot.bin
  - d. WBC\_FW\_QI\_1W\_V5.094.cab
- 2 Starting from the STWBC GUI folder, run the stwbc\_loader\_not\_empty.bat from the command line, specifying the COM number (e.g., COM2) and firmware filename (WBC\_FW\_QI\_1W\_V5.094.cab) parameters.

Figure 19: Command line

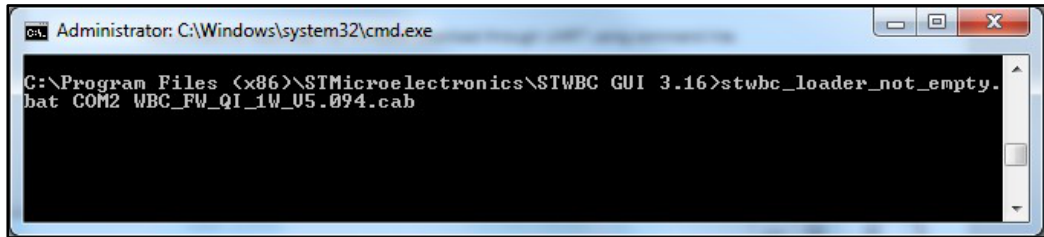

#### 3.4.2 With blank chip

If the STWBC-WA memory is erased, the sequencing of the procedure is a bit different.

- 1 Connect the UART cable, then select Load FW to board from the STWBC Qi GUI and power the board.
- 2 Execute the command line as per the example below.

Figure 20: Command line with blank chip

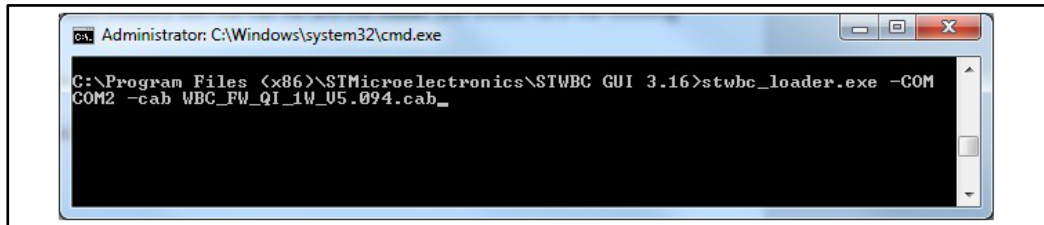

If the COM port number is greater than COM8, use the "\\.\COMx" syntax, where COMx is the COM port number.

### 3.5 STVP file creation to download with STVP

To use STVP to download the board, you must generate new files from the .cab, which you can do with the GUI.

- 1 Select the Convert CAB to STVP files command from the STWBC GUI Setup menu.

Figure 21: STWBC Convert CAB to STVP menu selection

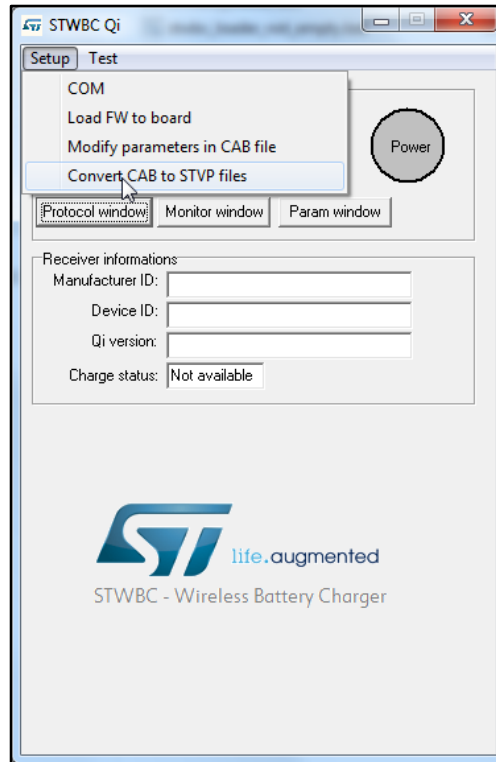

- 2 Follow the prompt to select the appropriate cab file.

Figure 22: Selecting cab file to convert

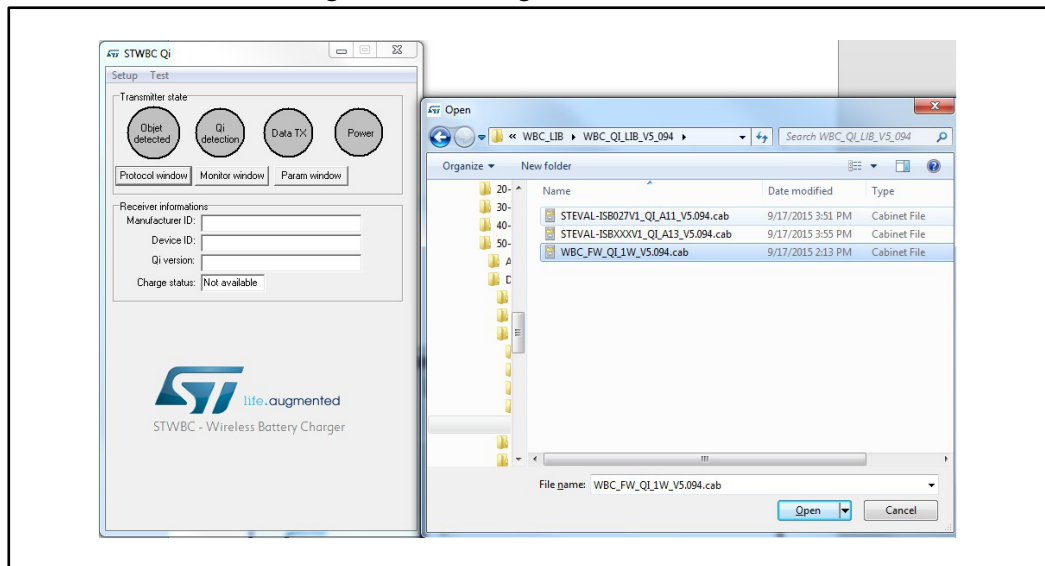

- 3 Follow the prompt to provide the project file name.

**Figure 23: Generated STVP project files**

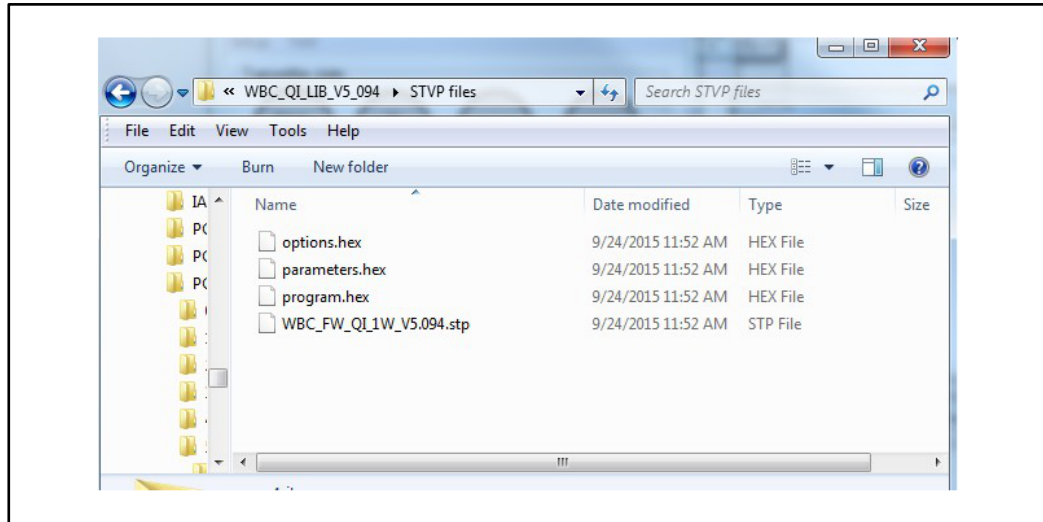

### 3.6 Firmware download with STVP

- 1 Target power off.
- 2 Target power on using a micro-USB cable to supply the board.
- 3 Connect the ST-LINK circuit to the computer by USB
- 4 Connect ST-LINK – SWIM cable with target. Pay special attention to connect the SWIM cable to the transmitter board correctly (white strip towards the bottom).  
See [Figure 13: "ST-LINK connection on the board"](#)
- 5 Launch STVP program
- 6 Select STM8AF6166 core  
see [Figure 15: "STVP core selection"](#)
- 7 In STVP, select Project > Open and select the .stp file inside the zip file.
- 8 Wait a few moments for the confirmation message to appear.
 

```

Loading file program.hex in PROGRAM MEMORY area ...
< File successfully loaded. File Checksum 0x1D1205

Some warnings may appear:
> Loading file options.hex in OPTION BYTE area ...
FILE : line 2: Address 0x4802 is out of range and is ignored!
FILE : line 2: Address 0x4804 is out of range and is ignored!

```
- 9 In STVP, select Program > All tabs (on active sectors if any)
- 10 Click OK if a "Wrong device selected" alert appears.  
see [Figure 17: "STVP wrong device selected alert"](#)
- 11 Click YES if "An incompatibility has been found with this device" query appears.  
see [Figure 18: "STVP incompatible device action query"](#)
- 12 On completion of the programming procedure starts, the STVP informs the user that the program is loaded

```
> Programming PROGRAM MEMORY area...  
< PROGRAM MEMORY programming completed.  
> Programming DATA MEMORY area...  
< DATA MEMORY programming completed.  
> Programming OPTION BYTE area...  
< OPTION BYTE programming completed.
```

- 13 CMD13: Exit from STVP.
- 14 Disconnect SWIM
- 15 Power off the board



The IAR Tool chain can also be used to compile and download firmware.

## 4 Setting up the evaluation equipment

The following block diagram shows the setup configuration for testing.

Figure 24: Transmitter – receiver test setup

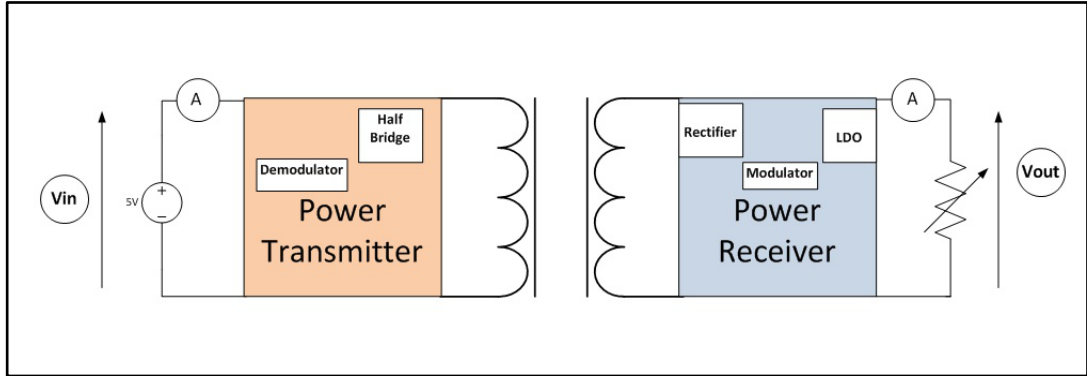

The board is powered with a 5 V / 1 A supply and an electronic load able to draw 1 W is connected on the receiver output. Voltmeters and ammeters measure input / output voltages and currents.

The GUI is installed on the PC which is connected to the board via the USB-to-UART dongle.

Figure 25: Transmitter – receiver setup with UART cable

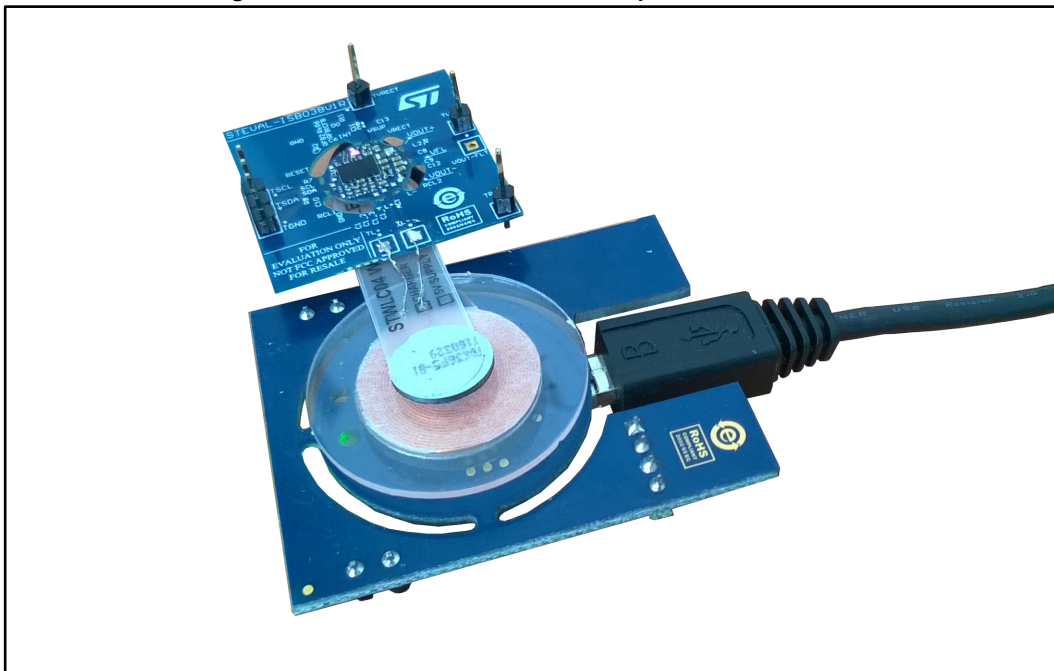



## 5 GUI and evaluation procedure

The STWBC GUI offers complete monitoring of STWBC-WA operation; the main screen provides transmitter and Qi receiver status information.

Figure 26: STWBC Qi transmission status information

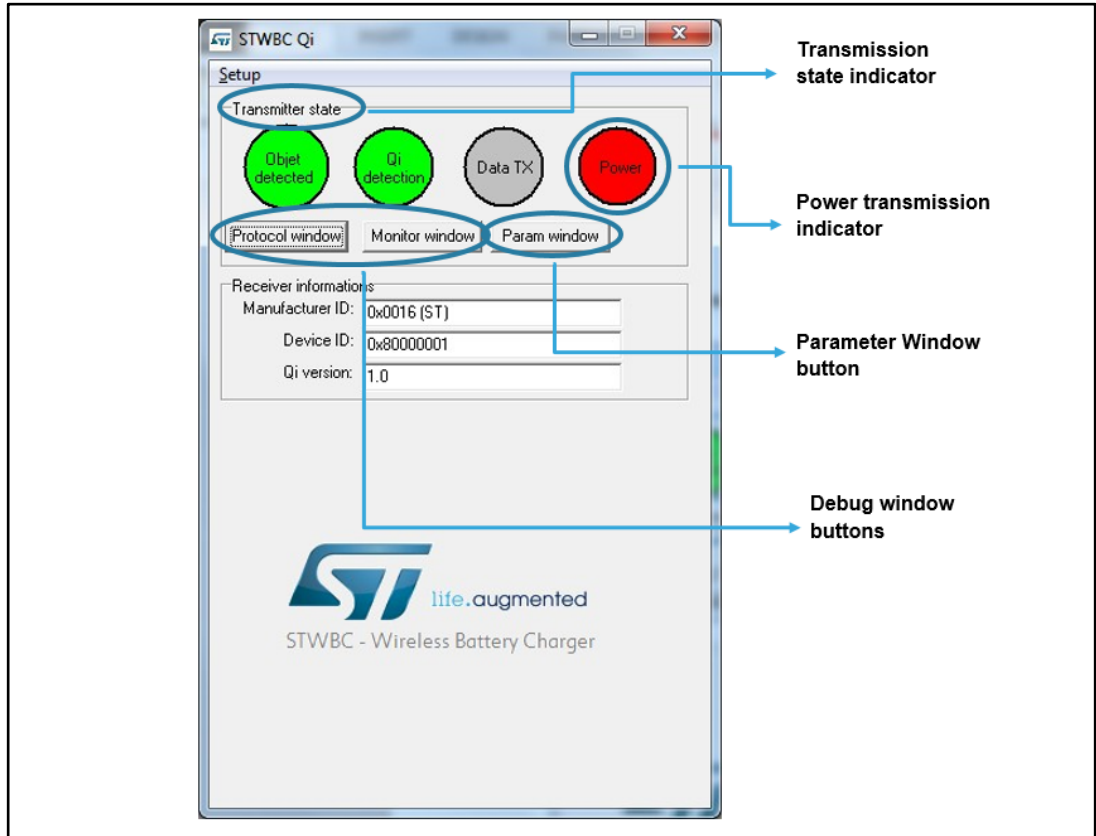

The STWBC GUI can also display the Rx to Tx communication protocol errors, which is helpful for system debugging.

Figure 27: STWBC Qi Protocol window

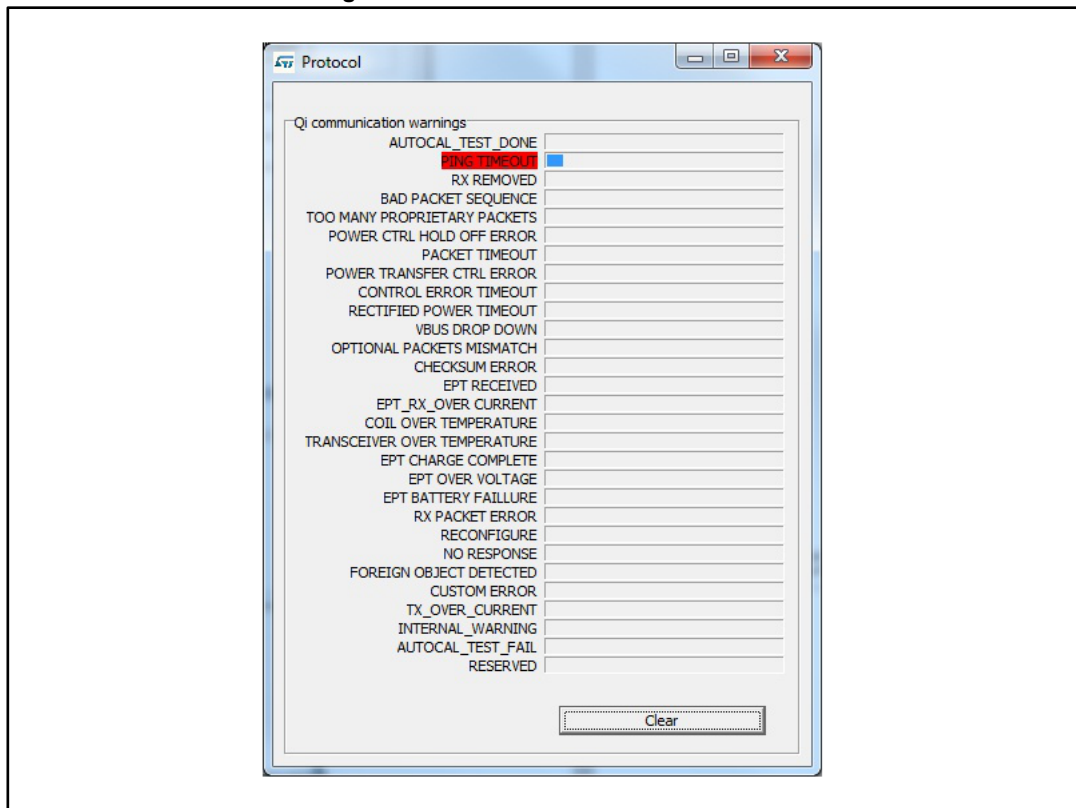

You can also monitor STWBC-WA internal variables such as bridge voltage, Rx reported power, coil temperature, etc.

Figure 28: STWBC Qi Monitor window

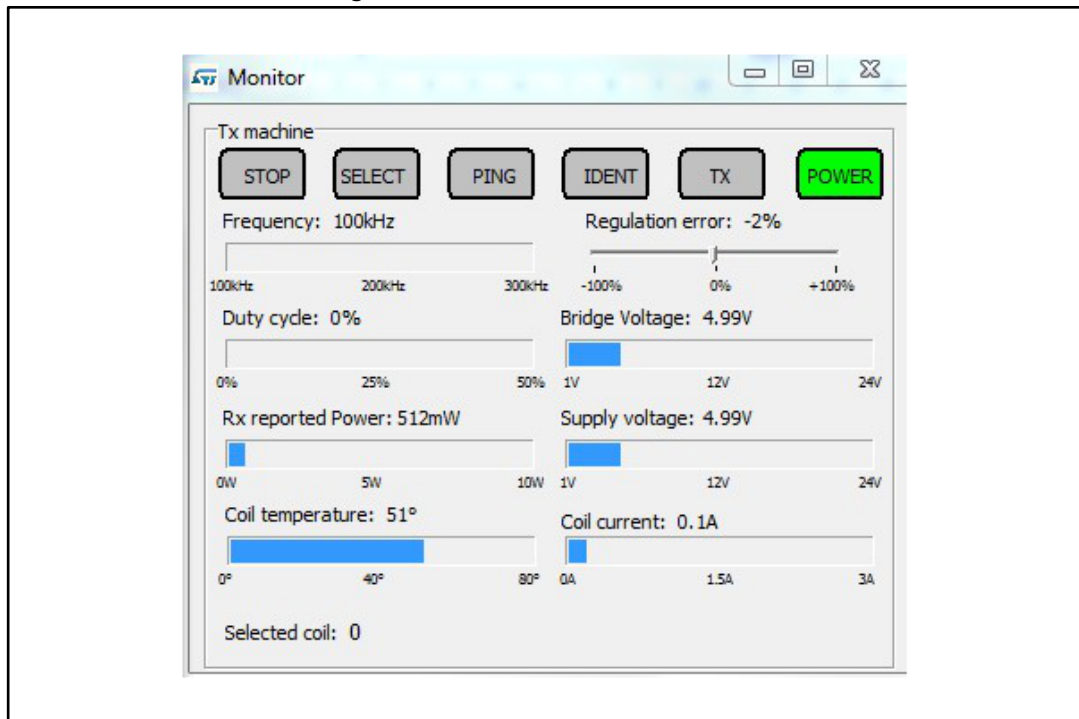

The user-friendly interface allows efficient system adjustment (thresholds, regulation error), and lets you store parameters to, and load parameters from, your computer.



Frequency and duty cycle are not available on the wearable Tx GUI.

The parameters have the following levels of protection:

1. Level 0: parameters can be modified without protection
2. Level 1: more critical parameters that can be modified with caution. You must “unlock param” before modifying it, but be cautious when doing so because it can lead to system malfunction or trigger behavior that is incompatible with the Qi standard.

Figure 29: STWBC Qi Parameters window

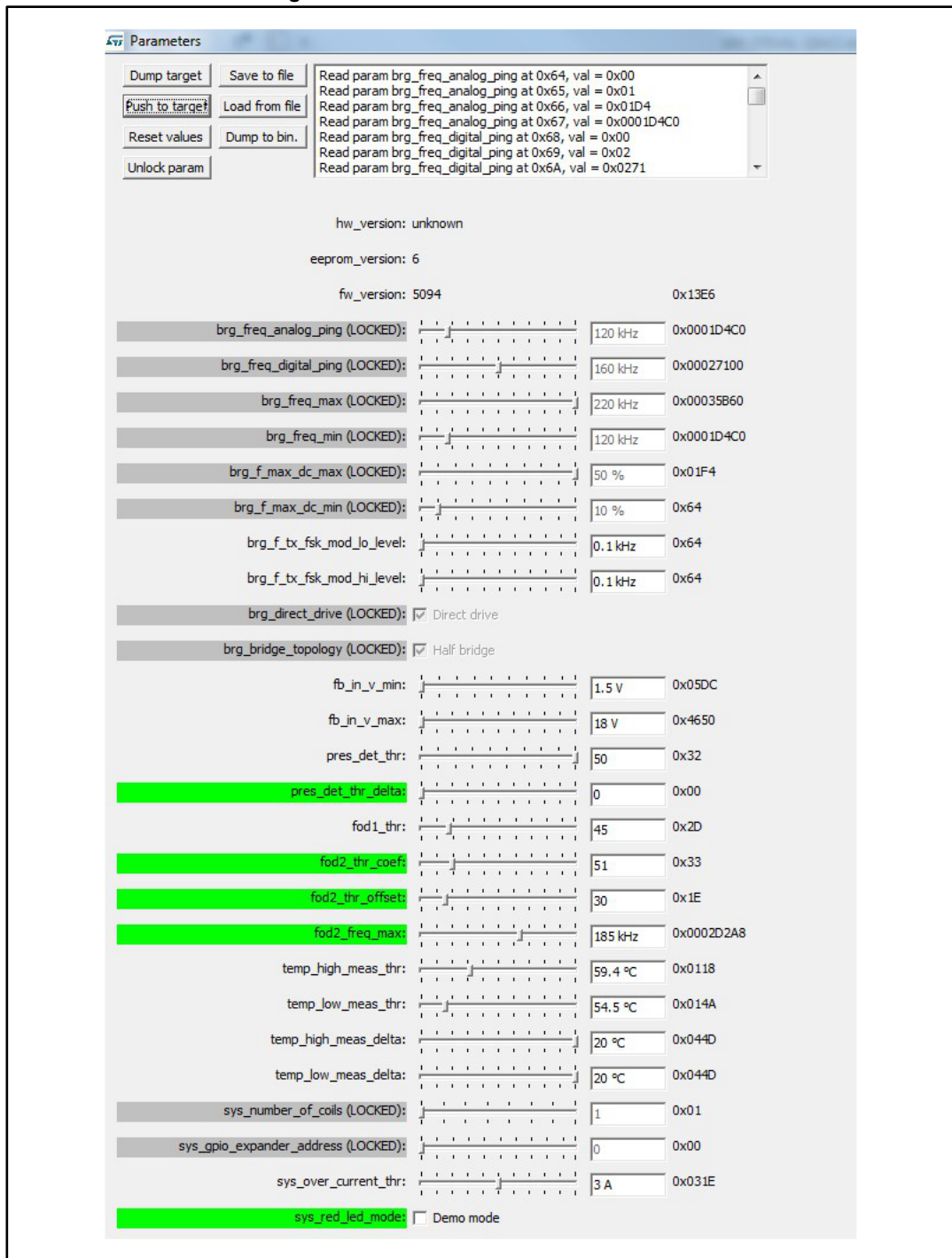

Parameters can be modified and their effect can be tested immediately by clicking Push to target; modified parameters lose their highlighted background.

Figure 30: STWBC Qi parameter modification (Push to target)

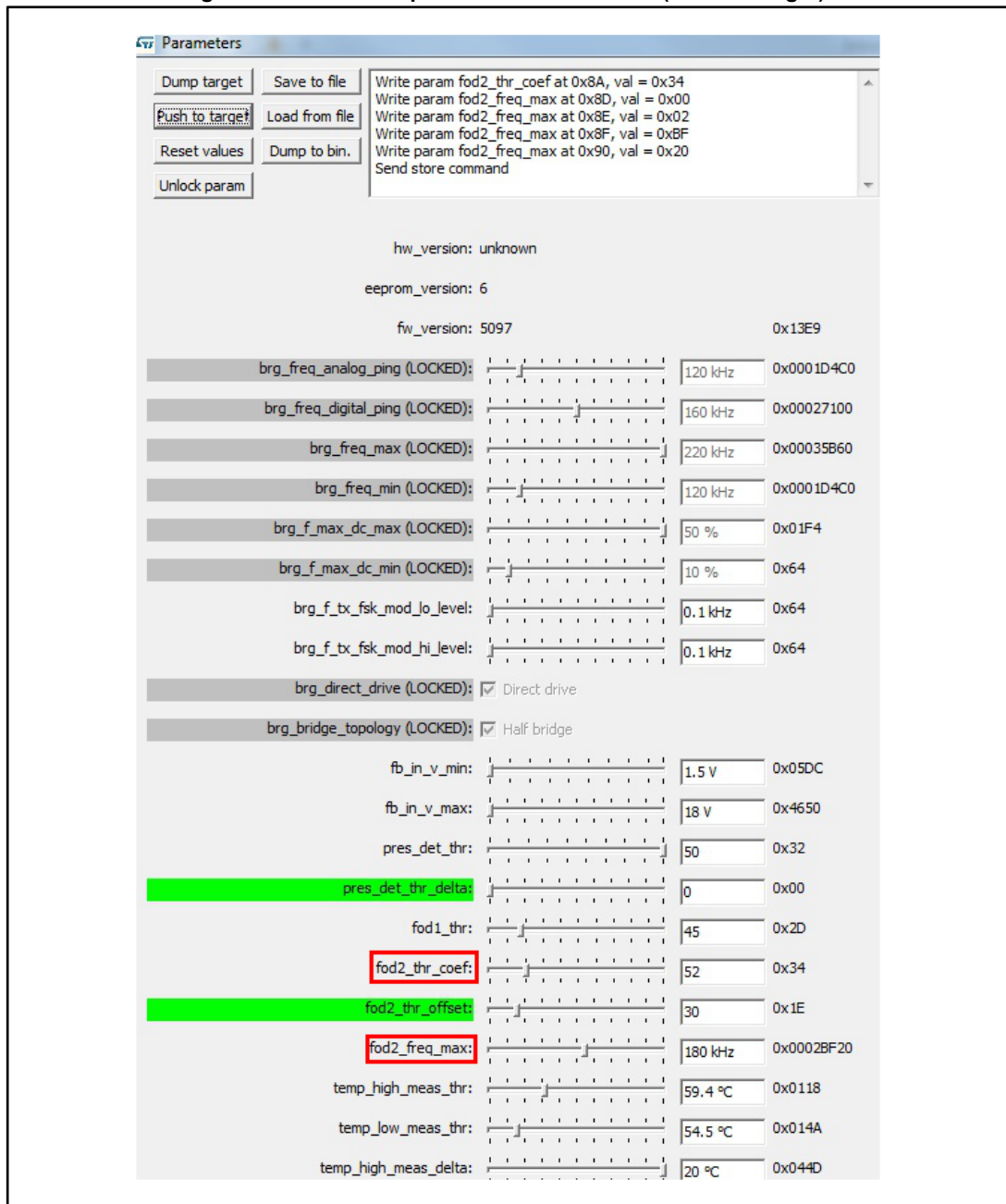

The STWBC GUI embeds the STWBC FW downloader interface (which uses the UART connection) and includes tools to generate binary files with adjusted parameters and build new firmware packages incorporating these files.

With the GUI, you can change the parameters and produce a new cab, which can then be used to program a batch of new boards. To do this, dump the parameters to a bin file, but only after you have clicked the Push to target button.

Figure 31: STWBC Qi saving modified parameters (Dump to bin.)

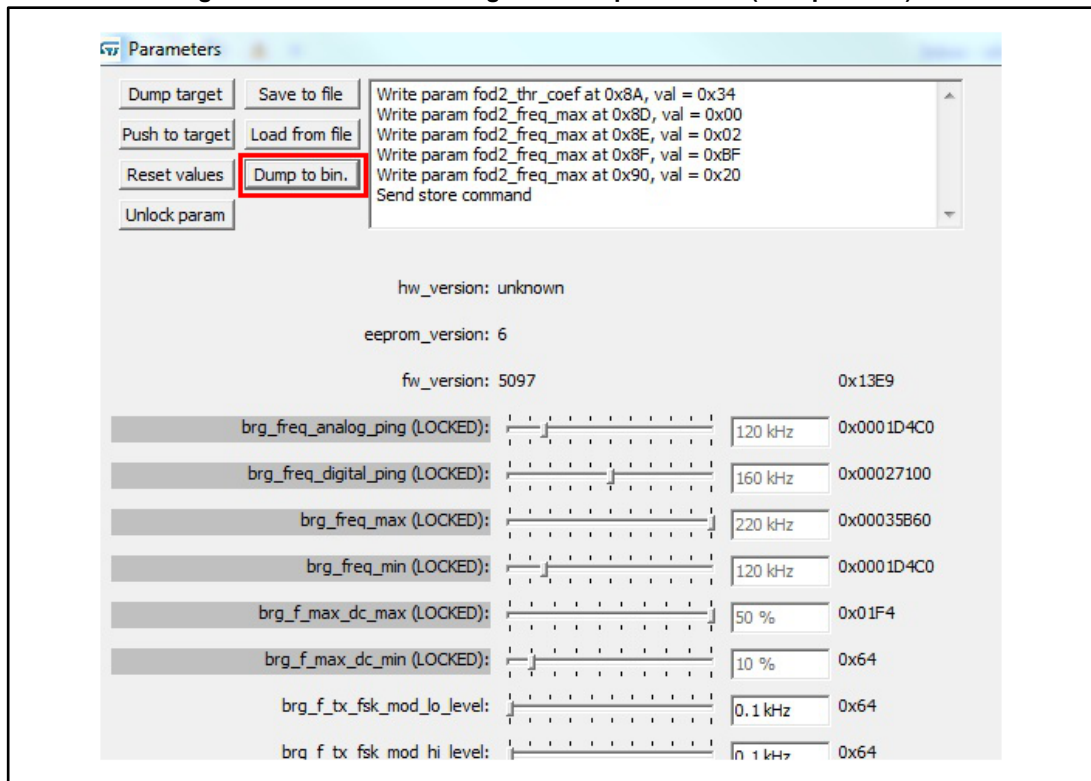

You can then select Modify parameters in CAB file from the Setup menu and select the appropriate firmware CAB file to be patched. This operation will alter the firmware file with new tuning parameters, which can be subsequently loaded using the standard procedure.

Figure 32: STWBC Qi updating firmware with new parameters



## 5.1 Status LEDs

The status LEDs indicate:

- **Green blinking:** power transfer in progress
- **Green steady on:** charging is complete
- **Red blinking:** error such as bad end of charge (battery fault), overvoltage, overcurrent, etc.
- **Red steady on:** the transmitter remains stuck until the receiver is removed, as per the Qi standard (power transfer stopped three consecutive times due to appropriate power not delivered to the receiver, end power transfer due to reconfigure, no response code, FOD detection after 3 attempts)
- **Red and green blinking once at startup:** a watchdog reset occurred
- **Red and green steady on:** firmware / STWBC-WA chip mismatch





Figure 34: STEVAL-ISB038V1T transmitter power stage

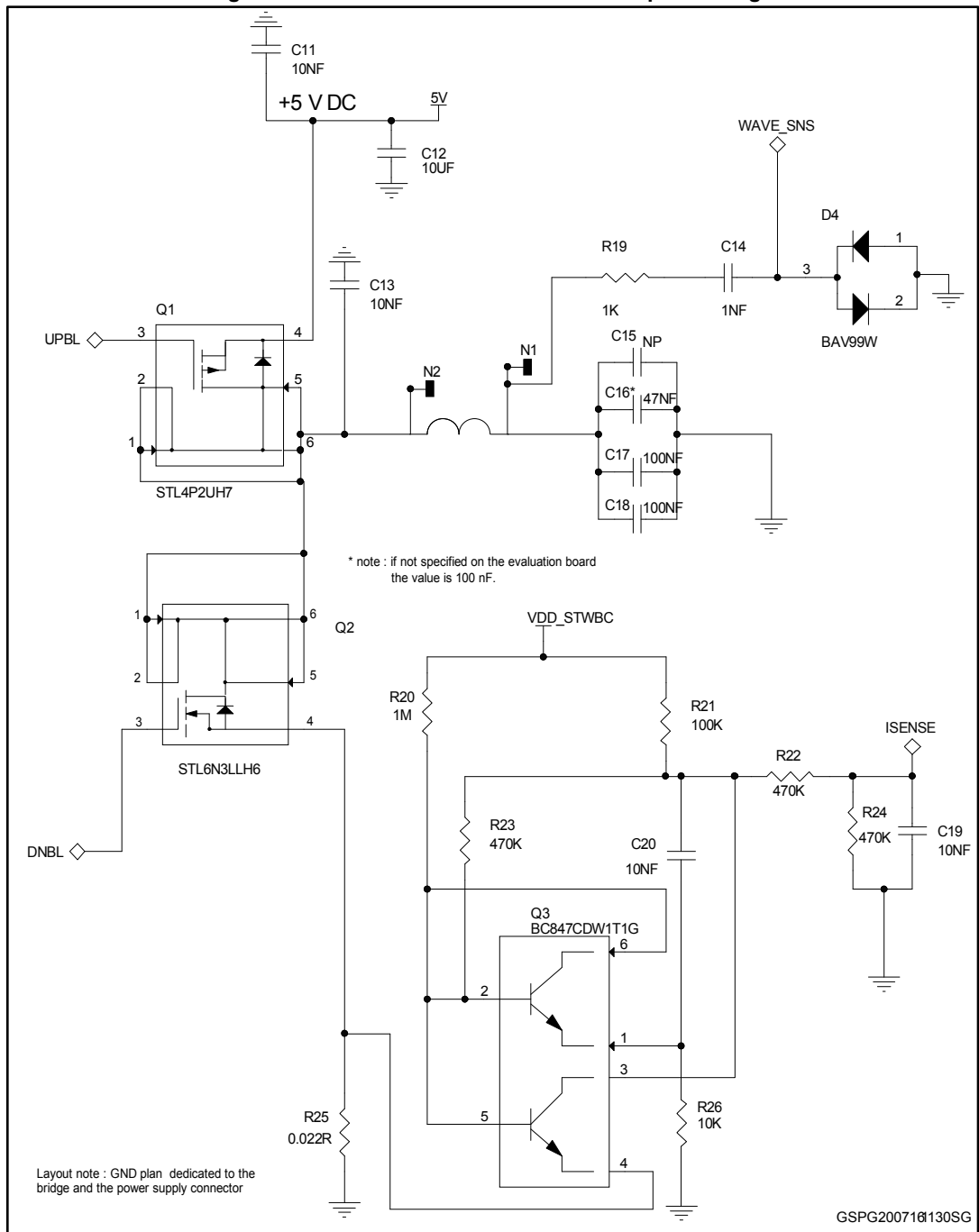
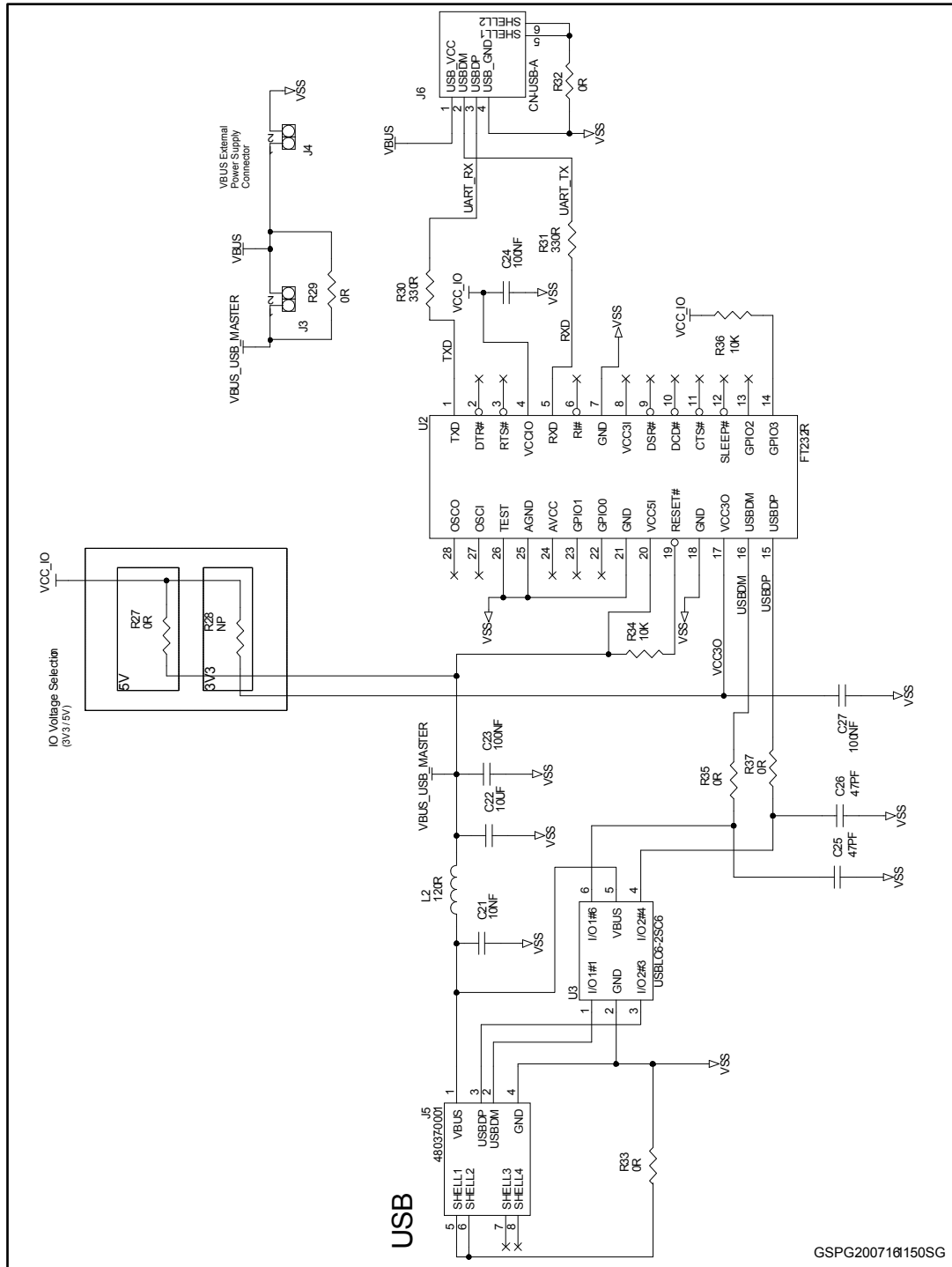

Figure 35: STEVAL-USB038V1T USB to UART dongle



GSPG200716150SG

## 7 Transmitter bill of materials

Table 6: STEVAL-ISB038V1T board bill of materials

Item	Q. ty	Ref	Part/Value	Description	Manufacturer	Part number
1	2	C1, C3	47 $\mu$ F, 16 V	CAP CER X5R 1210	Murata	GRM32ER61C476ME1 5
2	1	C2	4.7 nF, 50 V	CAP CER X7R 0402		4.7NF_50V_X7R_0402
3	7	C4, C9, C10, C11, C13, C19, C20	10 nF, 25 V $\pm$ 15%	CAP CER X7R 0402		10NF_50V_X7R_0402
4	3	C5, C6, C7	100 nF, 25 V	CAP CER X5R 0402		100NF_25V_X5R_040 2
5	1	C8	1 $\mu$ F, 16 V	CAP CER X5R 0402		1UF_16V_X5R_0402
6	2	C12, C22	10 $\mu$ F, 10 V	CAP CER X7R 0805	Murata	GRM21BR71A106KE5 1L
7	1	C14	1 nF, 50	CAP CER X5R 0402		1NF_50V_X5R_0402
8	1	C15		CAP NP 1206		C_NP_1206
9	1	C16	47 nF, 50 V $\pm$ 5%	CAP CER C0G 1206	Murata	GRM31M5C1H473JA0 1L
10	2	C17, C18	100 nF, 50 V $\pm$ 5%	CAP CER C0G 1206	Murata	GRM31C5C1H104JA0 1L
11	1	C21	10 nF, 50 V	CAP CER X7R 0603		10NF_50V_X7R_0603
12	3	C23, C24, C27	100 nF, 50 V	CAP CER X7R 0603		100NF_50V_X7R_060 3
13	2	C25, C26	47 pF, 25 V	CAP CER X5R 0603		47PF_25V_X5R_0603
14	1	D1		High power transient voltage suppressor	ST	ESDA7P60-1U1M
15	1	D2	RED, 2 V	LED side view 155124RS732 00	WURTH ELEKTRONIK	LED_155124_RED
16	1	D3	GREEN, 2 V	LED side view 155124VS732 00	WURTH ELEKTRONIK	LED_155124_GREEN

Item	Q. ty	Ref	Part/Value	Description	Manufacturer	Part number
17	1	D4		Double diode high speed switching diode		BAV99W-SOT323
18	1	J1		USB_B_MICR O_CMS	WURTH ELECTRONIK	629105136821
19	1	J2		4-way single row strip line connector (male connector) 2,54 mm pitch	RS	495-8470
20	2	J3, J4		STRIP254P-M-2	Molex	22-28-4023
21	1	J5		MOLEX 48037-0001 embase USB 2.0 type A traversant	Molex	48037-0001
22	1	J6		USB_B_TRAV type A - female	WURTH ELEKTRONIK	61400416021
23	1	L1	180 R	FERRITE BEAD, 180 Ohm, 0603	Murata	BLM41PG181SN1
24	1	L2	120 R, 500 mA, $\pm 25\%$	FERRITE BEAD, 120 Ohm, 0603, WE-CBF series	WURTH ELEKTRONIK	74279262
25	1	Q1	20 V, 0.087 Ohm typ., 4 A	P-channel STripFET H7 Power MOSFET in PowerFLAT 2x2 package	ST	STL4P2UH7
26	1	Q2	30 V, 21 m $\Omega$ typ., 6 A	N-channel STripFET H6 Power MOSFET, PowerFLAT 2x2 package	ST	STL6N3LLH6
27	1	Q3	45 V, 100 mA, 225 mW	XSTR, GEN PURP, dual NPN, SOT-363	ONSemiconductors	BC847CDW1T1G
28	1	R1	270 nH, $\pm 5\%$ , 110 mA	Inductor 0402	WURTH ELEKTRONIK	744784227A
29	1	R2	220 k Ohm 1% 1/16 W	RES 1/16W 0402 SMD		220K_1%_0402

Item	Q. ty	Ref	Part/Value	Description	Manufacturer	Part number
30	1	R3	1 K/0.2 A ± 25%	FERRITE BEAD 0402	Murata	BLM15AG102SN1D
31	2	R4, R20	1 m Ohm - 1/16 W	RES 1/16W 0402 SMD		1M_5%_0402
32	2	R5, R26	10 k Ohm 5%- 1/16 W	RES 1/16W 0402		10K_5%_0402
33	1	R6	47 k - Ohm 1% - 1/16 W	RES 1/16 W 0402 SMD		47K_1%_0402
34	4	R7, R8, R9, R11	0 Ohm 5% 1/16 W	RES 1/16 W 0402 SMD		0R_5%_0402
35	1	R10	180 k Ohm 5% 1/16 W	RES 1/16 W 0402		180K_5%_0402
36	5	R12, R16, R17, R18, R21	100 k Ohm 5% 1/16 W	RES 1/16 W 0402		100K_5%_0402
37	2	R13, R14	470 Ohm 5% 1/16 W	RES 1/16 W 0402 SMD		470R_5%_0402
38	1	R15	47 0K ±5%	Thermistance CTN	Murata	NCP18WB473J03RB
39	1	R19	1 k Ohm 5% 1/16 W	RES 1/16 W 0402 SMD		1K_5%_0402
40	3	R22, R23, R24	470 k Ohm 5%	RES		470K_5%_0402
41	1	R25	0.022 Ohm 2%	RES		0.022_ohm_2%_0805
42	4	R27, R33, R35, R37	0 Ohm 5% 1/10 W	RES 1/10 W 0603		0R_5%_0603
43	1	R28		RES NP 0603		R_NP_0603
44	2	R29, R32	0.0 Ohm 5% 1/10 W	RES 0603	Yageo	RC0603JR-070RL
45	2	R30, R31	330 R Ohm 5% 1/10 W	RES		330R_5%_0603
46	2	R34, R36	10 k Ohm 5% 1/10 W	RES		10K_5%_0603
47	1	U1		Digital controller	ST	STWBC-WA
48	1	U2		UART over USB bridge, SSOP28	FTDI	FT232R

Item	Q. ty	Ref	Part/Value	Description	Manufacturer	Part number
49	1	U3		USBLC6-2SC6 - Reseau de diode TVS USB2	ST	USBLC6-2SC6
50	1	WT202030-16M8 <sup>(1)</sup>	6.3 µH	Wireless power charging transmitter coil (TDK) 6.3 µH / 20 mm diameter	TDK	WT202030-16M8

**Notes:**

<sup>(1)</sup>Wireless power charging transmitter coil WT202030-16M8 can be replaced by the reference WT151512-22F2 by TDK (15mm diameter)

## 8 Transmitter board assembly and layout

The evaluation board is designed using a low cost two-layer PCB, with all the components on the top side. The test points allow the user to evaluate the STWBC-WA solution with probes. The UART is accessible through a micro-USB connector and SWIM connection is routed to a header connector on the cuttable section of the board.

The following figure shows the main functional block divisions on the board.

Figure 36: STEVAL-ISB038V1T evaluation board functional blocks

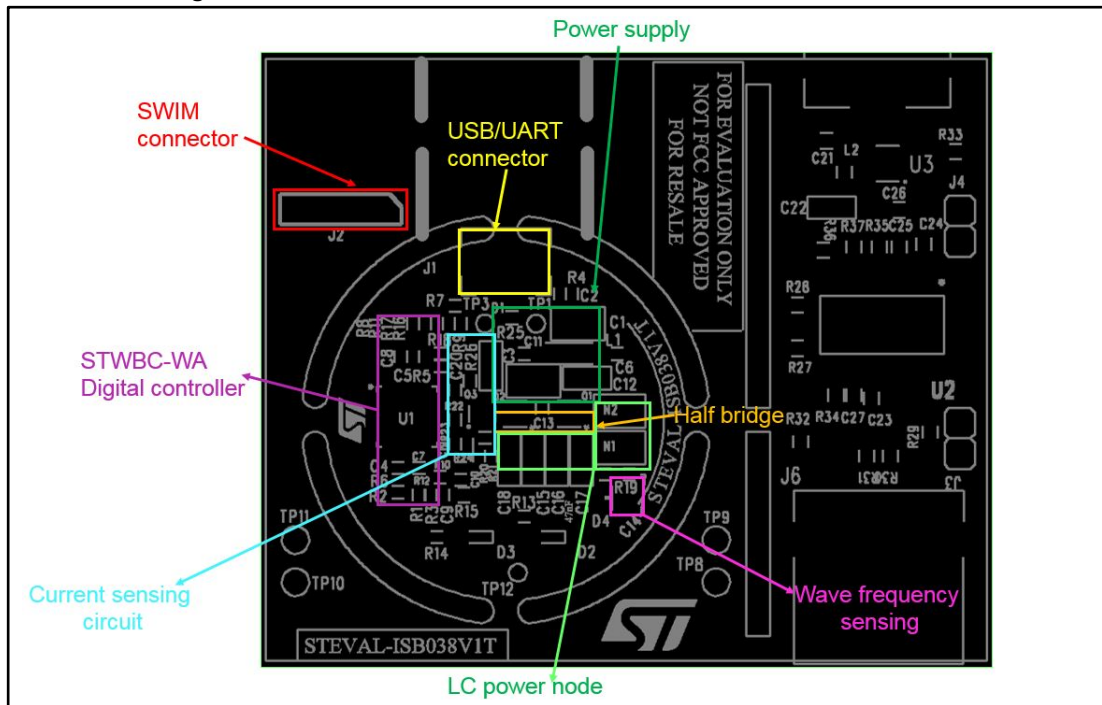

### 8.1 Design considerations

#### 8.1.1 Power signals (5V, GND and LC power node)

As the current flowing into the board can be relatively high, many vias must be used to route the 5 V and the power GND from top to bottom.

Large tracks or planes should be used for power GND, the 5 V supply voltage, VRSENSE and LC power node.

Figure 37: STEVAL-ISB038V1T power signal layout

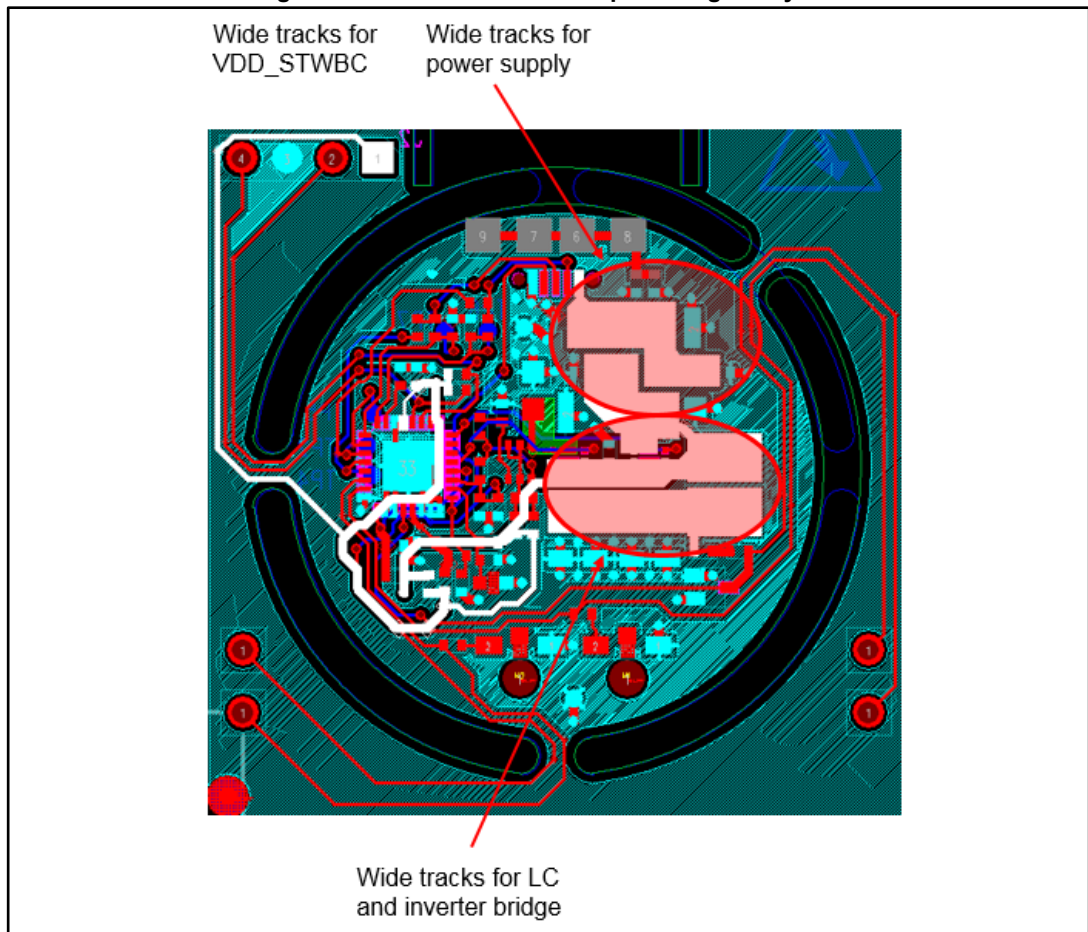

### 8.1.2 Sensitive signals

The layout must be clean on these signals to avoid coupling.



Figure 38: Isense and wave\_sns analog input signals routing

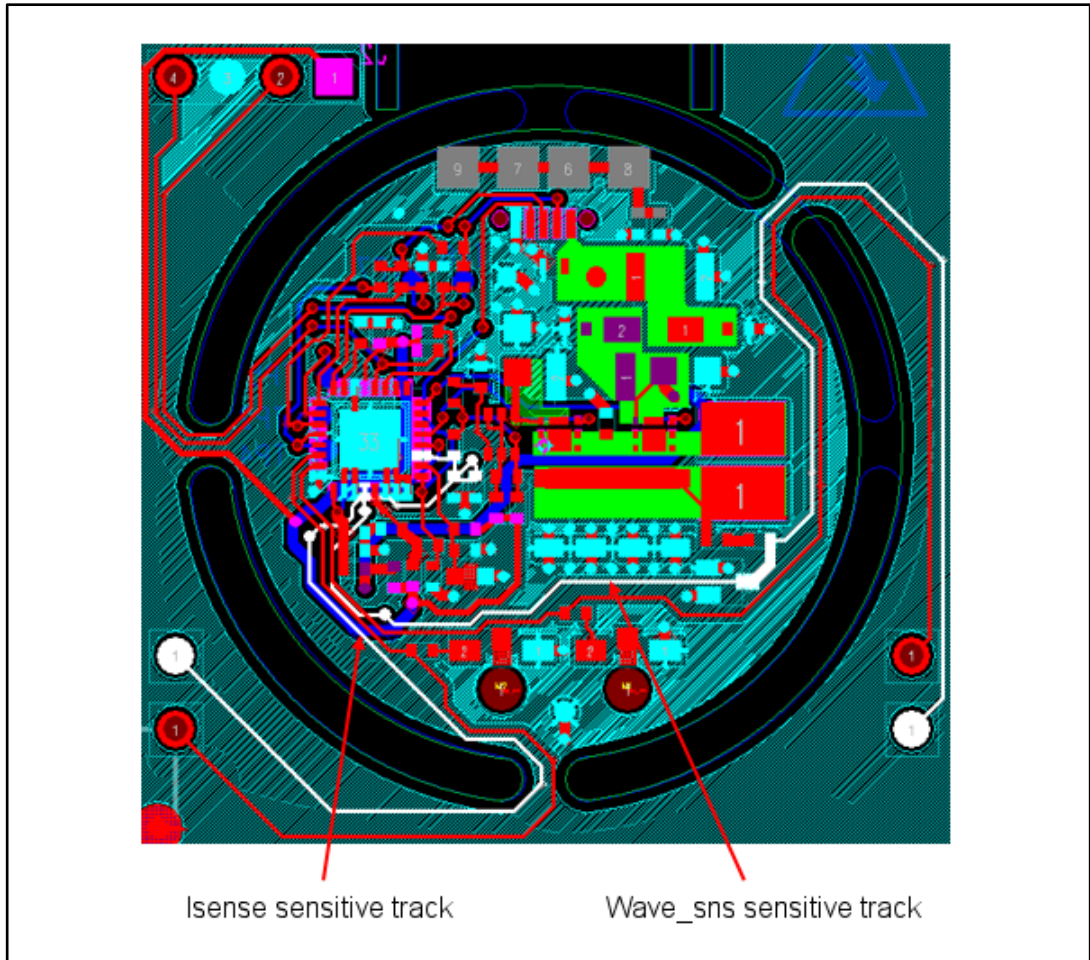
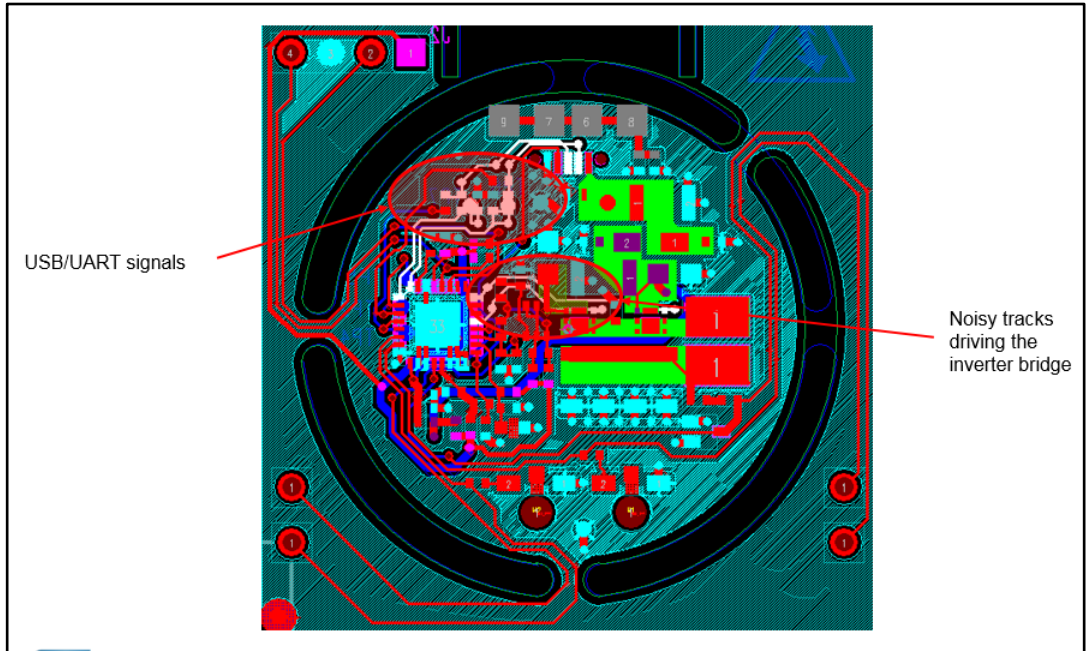

Figure 39: UART signals and switching signals driving the bridge



## 9 References

1. **Datasheet:** STWBC-WA – Digital controller for wireless battery charger transmitters for wearable application
2. **Data Brief:** STEVAL-ISB038V1T wireless charging transmitter evaluation board based on STWBC-WA
3. **User manual:** STWBC 1W turnkey firmware description

## 10 Revision history

Table 7: Document revision history

Date	Version	Changes
01-Sep-2016	1	Initial release.
21-Nov-2016	2	Updated <i>Figure 1: "STEVAL-ISB038V1T transmitter evaluation board"</i> , <i>Figure 33: "STEVAL-ISB038V1T transmitter control stage"</i> , <i>Figure 34: "STEVAL-ISB038V1T transmitter power stage"</i> , <i>Figure 35: "STEVAL-ISB038V1T USB to UART dongle"</i> ; <i>Table 6: "STEVAL-ISB038V1T board bill of materials"</i> ; <i>Figure 4: "Board silkscreen top layer"</i> ; <i>Figure 14: "SWIM wired connection"</i> and <i>Figure 36: "STEVAL-ISB038V1T evaluation board functional blocks"</i>
27-Jan-2017	3	Updated <a href="#">Table 6: "STEVAL-ISB038V1T board bill of materials"</a>

**IMPORTANT NOTICE – PLEASE READ CAREFULLY**

STMicroelectronics NV and its subsidiaries ("ST") reserve the right to make changes, corrections, enhancements, modifications, and improvements to ST products and/or to this document at any time without notice. Purchasers should obtain the latest relevant information on ST products before placing orders. ST products are sold pursuant to ST's terms and conditions of sale in place at the time of order acknowledgement.

Purchasers are solely responsible for the choice, selection, and use of ST products and ST assumes no liability for application assistance or the design of Purchasers' products.

No license, express or implied, to any intellectual property right is granted by ST herein.

Resale of ST products with provisions different from the information set forth herein shall void any warranty granted by ST for such product.

ST and the ST logo are trademarks of ST. All other product or service names are the property of their respective owners.

Information in this document supersedes and replaces information previously supplied in any prior versions of this document.

© 2017 STMicroelectronics – All rights reserved