

## 1A, 200V - 600V Surface Mount Super Fast Rectifiers

### FEATURES

- Glass passivated junction chip
- Ideal for automated placement
- Super fast recovery time for high efficiency
- Compliant to RoHS Directive 2011/65/EU and in accordance to WEEE 2002/96/EC
- Halogen-free according to IEC 61249-2-21

### APPLICATIONS

- High frequency rectification
- Freewheeling application
- Switching mode converters and inverters in computer, automotive and telecommunication.

### MECHANICAL DATA

- **Case:** DO-214AC (SMA)
- Molding compound, UL flammability classification rating 94V-0
- Moisture sensitivity level: level 1, per J-STD-020
- Part No. with suffix "H" means AEC-Q101 qualified
- Packing code with suffix "G" means green compound (halogen-free)
- **Terminal:** Matte tin plated leads, solderable per J-STD-002
- Meet JESD 201 class 2 whisker test
- **Polarity:** Indicated by cathode band
- **Weight:** 0.06 g (approximately)

KEY PARAMETERS		
PARAMETER	VALUE	UNIT
$I_{F(AV)}$	1	A
$V_{RRM}$	200-600	V
$I_{FSM}$	30	A
$V_F$ at $I_F=1A$	1.7	V
$T_{JMAX}$	150	°C
Package	DO-214AC (SMA)	
Configuration	Single dice	



DO-214AC (SMA)

ABSOLUTE MAXIMUM RATINGS ( $T_A = 25^\circ\text{C}$ unless otherwise noted)					
PARAMETER	SYMBOL	ES1LD	ES1LG	ES1LJ	UNIT
Marking code on the device		ES1LD	ES1LG	ES1LJ	
Maximum repetitive peak reverse voltage	$V_{RRM}$	200	400	600	V
Maximum RMS voltage	$V_{RMS}$	140	280	420	V
Maximum DC blocking voltage	$V_{DC}$	200	400	600	V
Maximum average forward rectified current	$I_{F(AV)}$	1			A
Peak forward surge current, 8.3 ms single half sine-wave superimposed on rated load	$I_{FSM}$	30			A
Operating Junction and Storage Temperature Range	$T_J, T_{STG}$	- 55 to +150			°C

<b>THERMAL PERFORMANCE</b>			
<b>PARAMETER</b>	<b>SYMBOL</b>	<b>LIMIT</b>	<b>UNIT</b>
Junction to Lead Thermal Resistance	$R_{\theta JL}$	35	°C/W
Junction to Ambient Thermal Resistance	$R_{\theta JA}$	80	°C/W
Junction to Case Thermal Resistance	$R_{\theta JC}$	25	°C/W

**Thermal Performance Note:** Units mounted on recommended PCB (16mm x 16mm Cu test board)

<b>ELECTRICAL SPECIFICATIONS</b> ( $T_A = 25^\circ\text{C}$ unless otherwise noted)						
<b>PARAMETER</b>		<b>CONDITIONS</b>	<b>SYMBOL</b>	<b>TYP</b>	<b>MAX</b>	<b>UNIT</b>
Maximum instantaneous forward voltage (Note 1)	ES1LD	$I_F = 1\text{A}$ $T_J = 25^\circ\text{C}$	$V_F$	-	0.95	V
	ES1LG			-	1.3	
	ES1LJ			-	1.7	
Maximum reverse current @ rated $V_R$ (Note 2)		$T_J = 25^\circ\text{C}$	$I_R$	-	5	$\mu\text{A}$
		$T_J = 125^\circ\text{C}$		-	100	$\mu\text{A}$
Junction capacitance	ES1LD	1 MHz, $V_R = 4.0\text{V}$	$C_J$	16	-	pF
	ES1LG			18		
	ES1LJ			18		
Reverse recovery time		$I_F = 0.5\text{A}$ $I_R = 1.0\text{A}$ $I_{RR} = 0.25\text{A}$	$t_{rr}$	-	35	ns

**Notes:**

1. Pulse test with  $PW = 0.3\text{ ms}$
2. Pulse test with  $PW = 30\text{ ms}$

**ORDERING INFORMATION**

PART NO.	PART NO. SUFFIX	PACKING CODE	PACKING CODE SUFFIX *	PACKAGE	PACKING
ES1Lx (Note 1)	H	R3	G	SMA	1,800 / 7" Plastic reel
		R2			7,500 / 13" Paper reel
		M2			7,500 / 13" Plastic reel
		F3		1,800 / 7" Plastic reel	
		F2		7,500 / 13" Paper reel	
		F4		7,500 / 13" Plastic reel	
	N/A	E3		Clip SMA	1,800 / 7" Plastic reel
					7,500 / 13" Plastic reel

Note 1: "x" defines voltage from 200V (ES1LD) to 600V (ES1LJ)

\*: G is optional available.

**EXAMPLE:**

EXAMPLE P/N	PART NO.	PART NO. SUFFIX	PACKING CODE	PACKING CODE SUFFIX	DESCRIPTION
ES1LDHR3G	ES1LD	H	R3	G	AEC-Q101 qualified Green compound

**CHARACTERISTICS CURVES**

( $T_A = 25^\circ\text{C}$  unless otherwise noted)

**Forward Current Derating Curve**

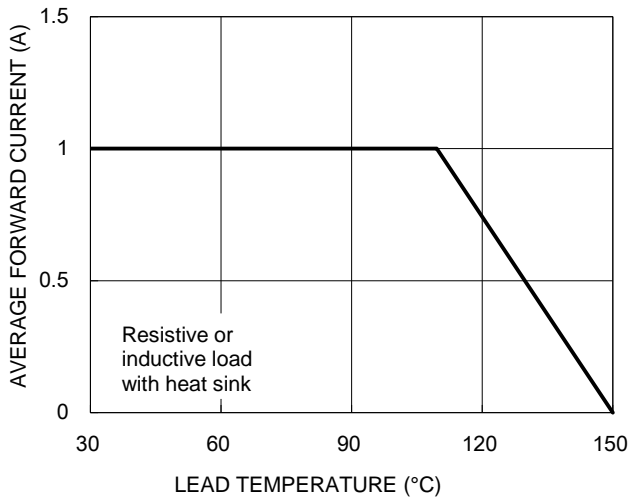

**Typical Junction Capacitance**

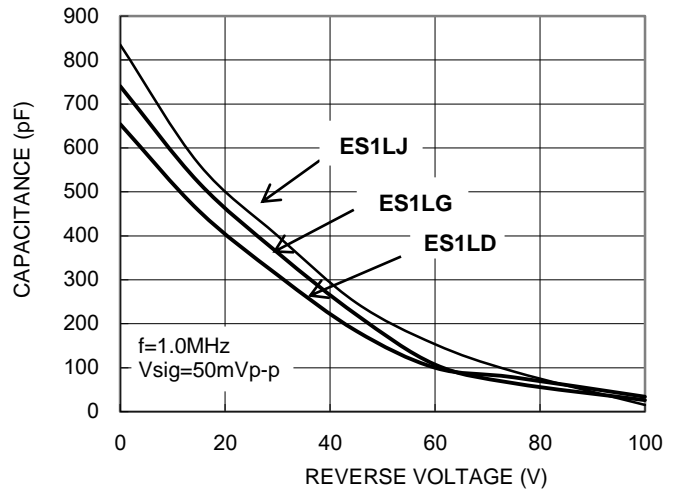

**TYPICAL REVERSE CHARACTERISTICS**

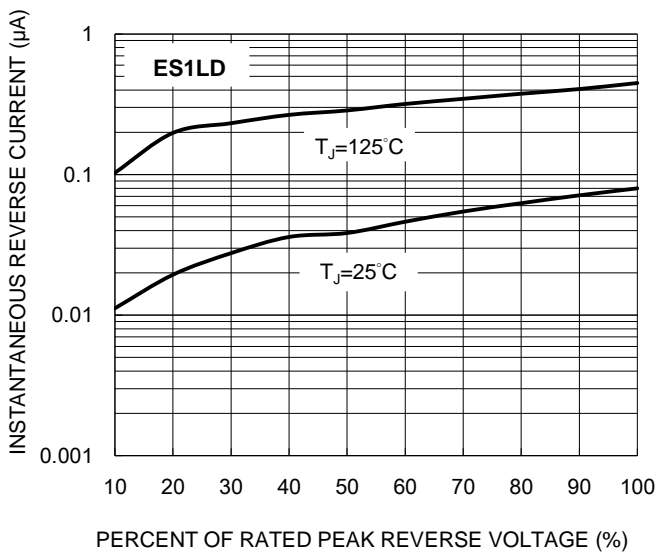

**TYPICAL FORWARD CHARACTERISTICS**

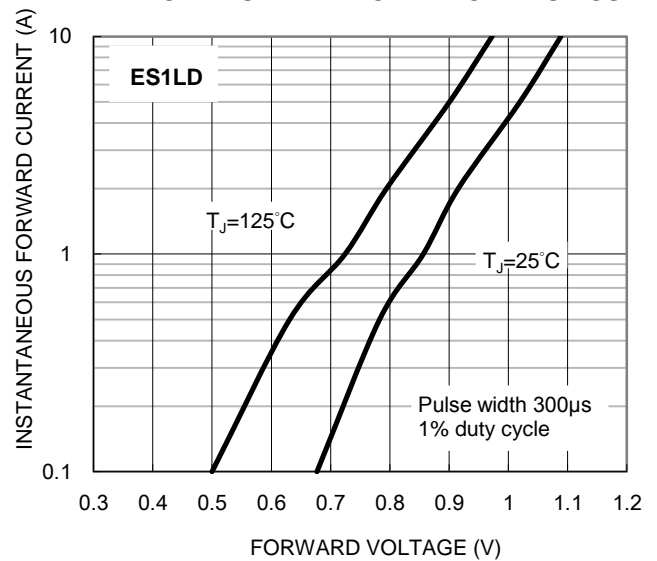

**CHARACTERISTICS CURVES**

( $T_A = 25^\circ\text{C}$  unless otherwise noted)

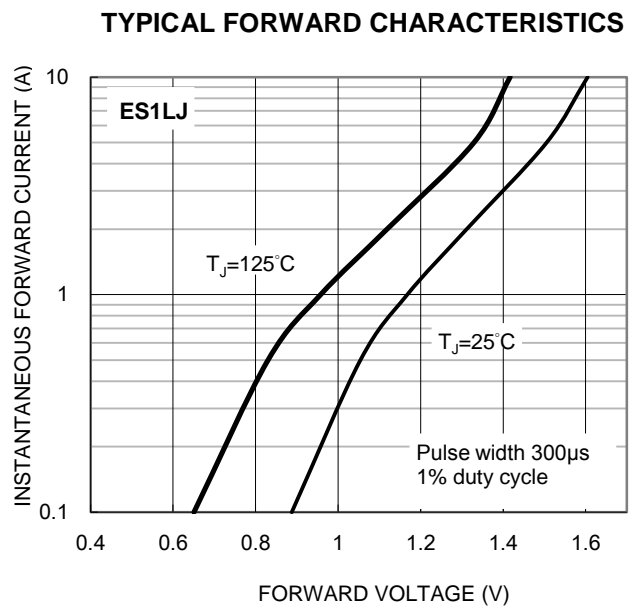
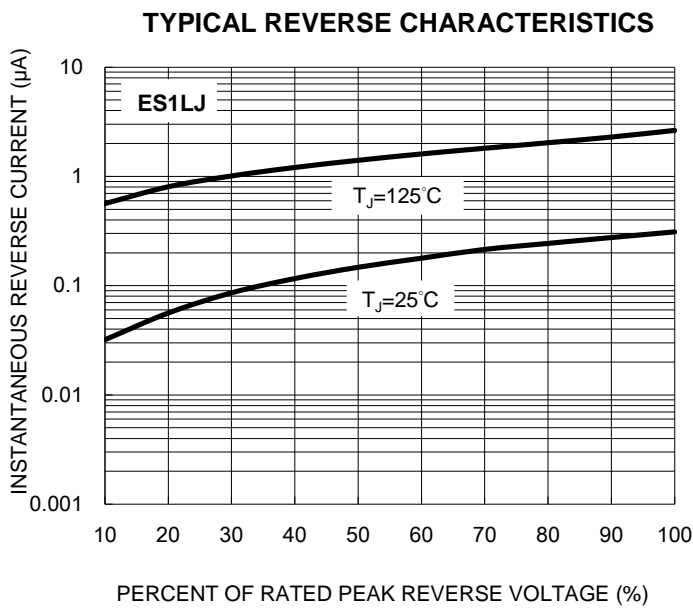
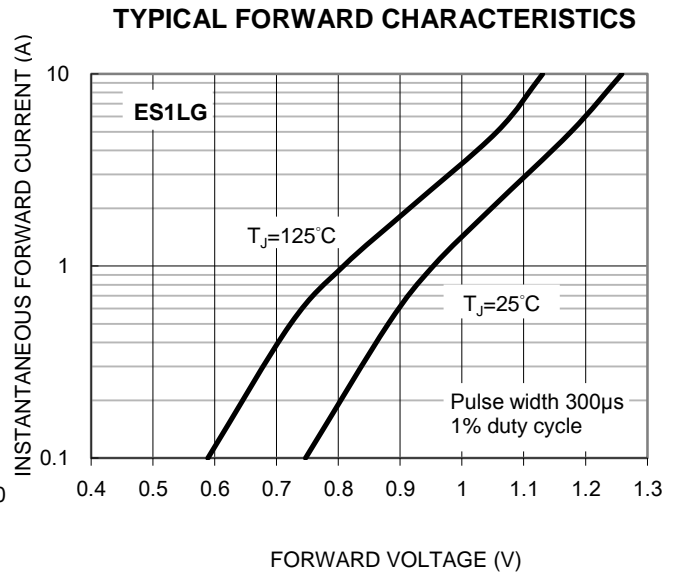
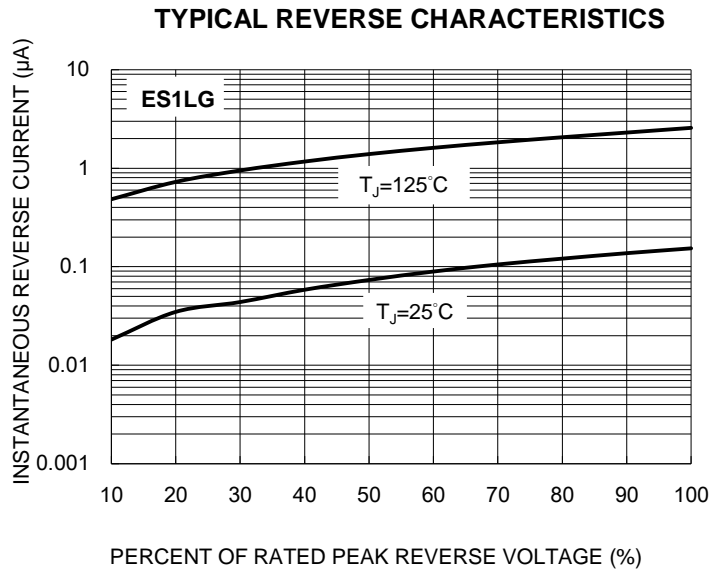

**PACKAGE OUTLINE DIMENSIONS** (Unit: Millimeters)

**DO-214AC (SMA)**

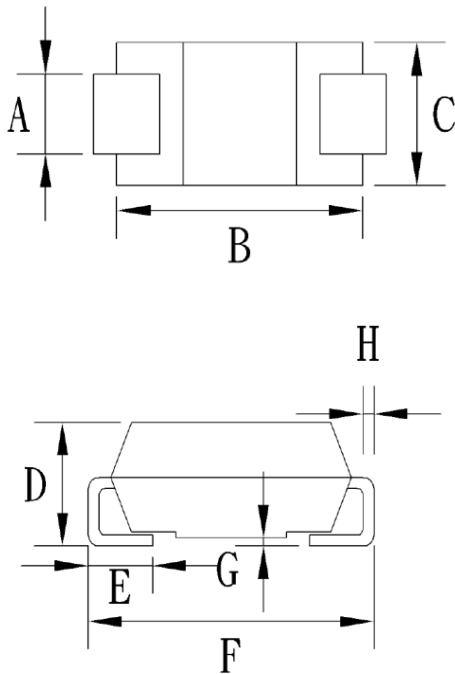

DIM	Unit (mm)		Unit (inch)	
	Min	Max	Min	Max
A	1.27	1.58	0.050	0.062
B	4.06	4.60	0.160	0.181
C	2.29	2.83	0.090	0.111
D	1.99	2.50	0.078	0.098
E	0.90	1.41	0.035	0.056
F	4.95	5.33	0.195	0.210
G	0.10	0.20	0.004	0.008
H	0.15	0.31	0.006	0.012

**SUGGESTED PAD LAYOUT** (Unit: Millimeters)

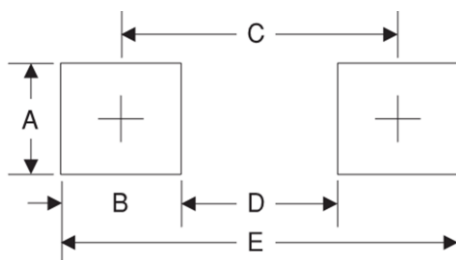

Symbol	Unit (mm)	Unit (inch)
A	1.68	0.066
B	1.52	0.060
C	3.93	0.155
D	2.41	0.095
E	5.45	0.215

**MARKING DIAGRAM**



- P/N = Specific Device Code
- G = Green Compound
- YW = Date Code
- F = Factory Code

## Notice

Specifications of the products displayed herein are subject to change without notice. TSC or anyone on its behalf, assumes no responsibility or liability for any errors or inaccuracies.

Information contained herein is intended to provide a product description only. No license, express or implied, to any intellectual property rights is granted by this document. Except as provided in TSC's terms and conditions of sale for such products, TSC assumes no liability whatsoever, and disclaims any express or implied warranty, relating to sale and/or use of TSC products including liability or warranties relating to fitness for a particular purpose, merchantability, or infringement of any patent, copyright, or other intellectual property right.

The products shown herein are not designed for use in medical, life-saving, or life-sustaining applications. Customers using or selling these products for use in such applications do so at their own risk and agree to fully indemnify TSC for any damages resulting from such improper use or sale.