

Preliminary Specifications

Final Specifications

<b>Module</b>	7.0 Inch Color TFT-LCD
<b>Model Name</b>	G070VW01 V0

<b>Customer</b>	<b>Date</b>
<p style="text-align: center;"><b>Checked &amp; Approved by</b></p> <p>_____</p>	<p>_____</p>
<p>Note: This Specification is subject to change without notice.</p>	

<b>Approved by</b>	<b>Date</b>
<p>_____ Debbie Chiu</p>	<p>_____ 2009/5/15</p>
<b>Prepared by</b>	
<p>_____ Alex Cheng</p>	<p>_____ 2009/5/15</p>
<p>General Display Business Division / AU Optronics corporation</p>	

AUO Confidential For PROMATE Internal Use Only / 2009/6/17

## Contents

<b>1. Operating Precautions .....</b>	<b>4</b>
<b>2. General Description .....</b>	<b>5</b>
2.1 Display Characteristics .....	5
2.2 Optical Characteristics .....	6
<b>3. Functional Block Diagram .....</b>	<b>9</b>
<b>4. Absolute Maximum Ratings.....</b>	<b>10</b>
4.1 Absolute Ratings of TFT LCD Module.....	10
4.2 Absolute Ratings of Environment.....	10
<b>5. Electrical Characteristics.....</b>	<b>11</b>
5.1 TFT LCD Module .....	11
5.2 Backlight Unit.....	13
<b>6. Signal Characteristic.....</b>	<b>14</b>
6.1 Pixel Format Image.....	14
6.2 Signal Description .....	15
6.3 Scanning Direction.....	16
6.4 The Input Data Format.....	17
6.5 Interface Timing .....	18
6.6 Power ON/OFF Sequence .....	19
<b>7. Connector &amp; Pin Assignment .....</b>	<b>20</b>
7.1 TFT LCD Signal (CN1): LVDS Connector .....	20
7.2 LED Backlight Unit (CN2): LED Driver Connector.....	20
7.3 LED Light Bar Input Connector (CN4): .....	21
<b>8. Reliability Test Criteria.....</b>	<b>21</b>
<b>9. Mechanical Characteristics .....</b>	<b>22</b>
9.1 LCM Front View .....	22
9.2 LCM Rear View.....	23
<b>10. Label and Packaging.....</b>	<b>24</b>
10.1 Shipping Label (on the rear side of TFT-LCD display) .....	24
10.2 Carton Package .....	24
<b>11 Safety.....</b>	<b>25</b>
<b>11 Safety.....</b>	<b>25</b>
11.1 Sharp Edge Requirements.....	25
11.2 Materials.....	25
11.3 Capacitors.....	25
11.4 National Test Lab Requirement.....	25

## Record of Revision

Version and Date	Page	Old description	New Description
0.0 2008/10/17	All	First Edition	
0.1 2008/12/18	18	LED Backlight Unit (CN2) Pin description	Pin description has been corrected.
0.2 2009/1/8	6	Viewing Angle(L/R/U/D) 80/80/60/80 (Typ.); 70/70/55/65 (Min.)	Viewing Angle(L/R/U/D) 80/80/80/80 (Typ.); 70/70/70/70 (Min.)
0.2 2009/1/8	18	Dimming: Analog, 0.3~1.2V (10~100%)	Dimming: Analog, 0~5V (10~100%)
0.3 2009/3/2	5	Typical power consumption 4.2w	Typical power consumption 3.7w
	5		Wieght :165 ± 10 g
	6		Uniformity:1.3
	11		Update 5.1.1 Power specification
	13		Update 5.2.1 Parameter guideline for LED
	17		Update 6.6 Power ON/OFF Sequence
	18		Update 6.5.1 Timing characteristics
	20		Update 7.2 Pin descripton
1.0 2009/04/23	20		LVDS Connector: Add Manufacturer: STM Connector Model Number: Add STM-MSB24013P20HA Mating Model Number: Add STM-P24013P20
	6	Contrast Ratio: 500(Typ)	Contrast Ratio: 1000(Typ); 750(min)
	6		Update Color / Chromaticity Coordinates
	13		Update min Swing Voltage=0.3V
	1.1 2009/05/15	13	
	21		Add 7.3 LED Light Bar Input Connector description
	23		Add the description of LED Light Bar connector in LCM Rear View

AUO Confidential For PROMATE Internal Use Only

## 1. Operating Precautions

- 1) Since front polarizer is easily damaged, please be cautious not to scratch it.
- 2) Be sure to turn off power supply when inserting or disconnecting from input connector.
- 3) Wipe off water drop immediately. Long contact with water may cause discoloration or spots.
- 4) When the panel surface is soiled, wipe it with absorbent cotton or soft cloth.
- 5) Since the panel is made of glass, it may be broken or cracked if dropped or bumped on hard surface.
- 6) To avoid ESD (Electro Static Discharge) damage, be sure to ground yourself before handling TFT-LCD Module.
- 7) Do not open nor modify the module assembly.
- 8) Do not press the reflector sheet at the back of the module to any direction.
- 9) In case if a module has to be put back into the packing container slot after it was taken out from the container, do not press the center of the LED Reflector edge. Instead, press at the far ends of the LED Reflector edge softly. Otherwise the TFT Module may be damaged.
- 10) At the insertion or removal of the Signal Interface Connector, be sure not to rotate nor tilt the Interface Connector of the TFT Module.
- 11) After installation of the TFT Module into an enclosure (Notebook PC Bezel, for example), do not twist nor bend the TFT Module even momentarily. At designing the enclosure, it should be taken into consideration that no bending/twisting forces are applied to the TFT Module from outside. Otherwise the TFT Module may be damaged.
- 12) Small amount of materials having no flammability grade is used in the LCD module. The LCD module should be supplied by power complied with requirements of Limited Power Source (IEC60950 or UL1950), or be applied exemption.
- 13) Severe temperature condition may result in different luminance, response time.
- 14) Continuous operating TFT-LCD Module under high temperature environment may accelerate LED light bar exhaustion and reduce luminance dramatically.
- 15) The data on this specification sheet is applicable when LCD module is placed in landscape position.
- 16) Continuous displaying fixed pattern may induce image sticking. It is recommended to use screen saver or shuffle content periodically if fixed pattern is displayed on the screen.

## 2. General Description

This specification applies to the 7.0 inch color TFT LCD module G070VW01 V0.

G070VW01 V0 designed with wide viewing angle; wide operating temperature and long life LEDs backlight is well suited to be the display units for Industrial Applications.

LED driving board for backlight unit is included in this panel and the structure of the LED units is replaceable.

G070VW01 V0 is built in timing controller and LVDS interface.

The screen format is intended to support the WVGA (800(H) x 480(V)) screen and 16.2M (RGB 8-bits) or 262k colors (RGB 6-bits).

G070VW01 V0 is a RoHS product.

### 2.1 Display Characteristics

The following items are characteristics summary on the table under 25 °C condition:

Items	Unit	Specifications
Screen Diagonal	[inch]	7.0 ( 177.8mm )
Active Area	[mm]	152.40(H) x 91.44(V)
Pixels H x V		800x3(RGB) x 480
Pixel Pitch	[mm]	0.1905x 0.1905
Pixel Arrangement		R.G.B. Vertical Stripe
Display Mode		TN, Normally White
Nominal Input Voltage VDD	[Volt]	3.3 typ.
Typical Power Consumption	[Watt]	3.7 typ.
Weight	[Grams]	165 ± 10
Physical Size	[mm]	170.0(W) x 111.0(H) x 7.5(D) (typ.)
Electrical Interface		1 channel LVDS
Surface Treatment		Anti-glare, Hardness 3H
Support Color		262K(6-bit) / 16.2M(8-bit)
Temperature Range Operating Storage (Non-Operating)	[°C] [°C]	-30 to +85 (panel surface temperature) -30 to +85
RoHS Compliance		RoHS Compliance

## 2.2 Optical Characteristics

The optical characteristics are measured under stable conditions at 25°C (Room Temperature):

Item	Unit	Conditions	Min.	Typ.	Max.	Note
White Luminance	[cd/m <sup>2</sup> ]	I <sub>F</sub> = 80mA (center point)	300	400	-	1
Uniformity		5 Points		-	1.3	1.2.3
Contrast Ratio			750	1000	-	4
Response Time	[msec]	Rising	-	20	30	5
	[msec]	Falling	-	10	20	
	[msec]	Rising + Falling	-	30	50	
Viewing Angle	[degree]	Horizontal (Right) CR □ 10 (Left)	70	80	-	6
	[degree]		70	80	-	
	[degree]	Vertical (Upper) CR □ 10 (Lower)	70	80	-	
	[degree]		70	80	-	
Color / Chromaticity Coordinates (CIE 1931)		Red x	0.55	0.60	0.65	1
		Red y	0.30	0.35	0.40	
		Green x	0.27	0.32	0.37	
		Green y	0.55	0.60	0.65	
		Blue x	0.10	0.15	0.20	
		Blue y	0.03	0.08	0.13	
		White x	0.26	0.31	0.36	
		White y	0.28	0.33	0.38	
Color Gamut	%		-	60	-	1

Note 1: Measurement method

Equipment : Pattern Generator, Power Supply, Digital Voltmeter, Luminance meter (SR\_3 or equivalent)

Aperture 1□with 50cm viewing distance

Test Point Center

Environment < 1 lux

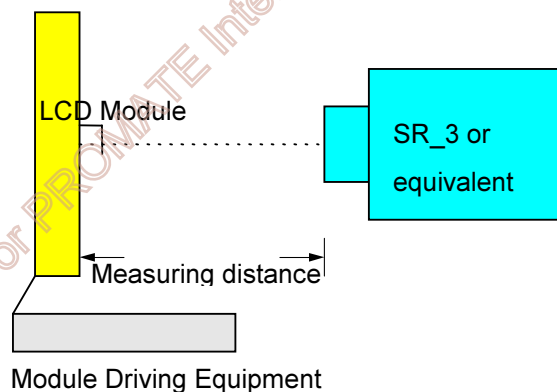

Note 2: Definition of 5 points position (Display active area: 152.40(H) x 91.44(V))

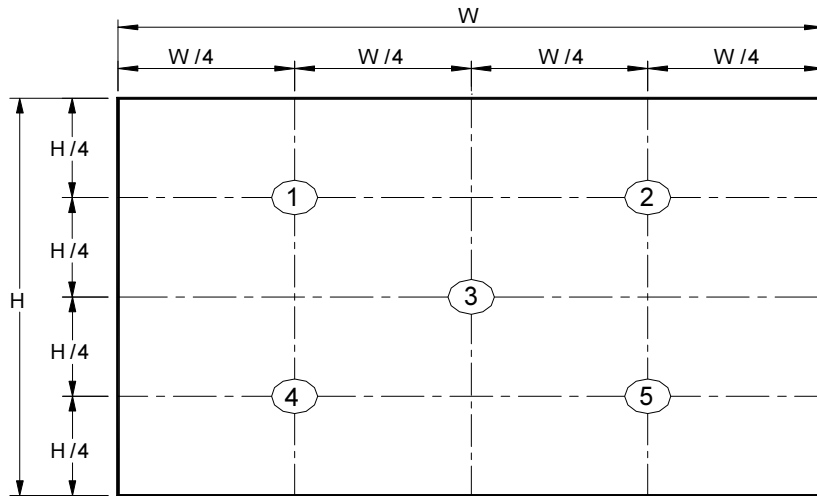

Note 3:

The luminance uniformity of 5 points is defined by dividing the maximum luminance value by the minimum luminance value at full white condition.

$$\delta_{W5} = \frac{\text{Maximum Brightness of five points}}{\text{Minimum Brightness of five points}}$$

Note 4 : Definition of contrast ratio (CR):

$$\text{Contrast ratio (CR)} = \frac{\text{Brightness on the "White" state}}{\text{Brightness on the "Black" state}}$$

Note 5: Definition of response time:

The output signals of photo detector are measured when the input signals are changed from "White" to "Black" (falling time) and from "Black" to "White" (rising time), respectively. The response time interval is between 10% and 90% of amplitudes. Please refer to the figure as below.

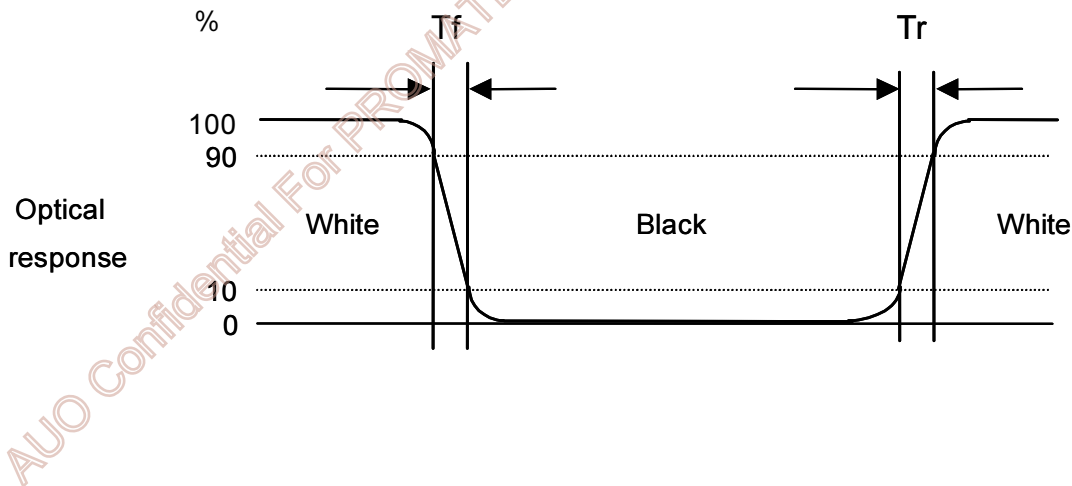

Note 6: Definition of viewing angle

Viewing angle is the measurement of contrast ratio  $\geq 10$ , at the screen center, over a 180° horizontal and 180° vertical range (off-normal viewing angles). The 180° viewing angle range is broken down as below: 90° ( $\theta$ ) horizontal left and right, and 90° ( $\Phi$ ) vertical high (up) and low (down). The measurement direction is typically perpendicular to the display surface with the screen rotated to its center to develop the desired measurement viewing angle.

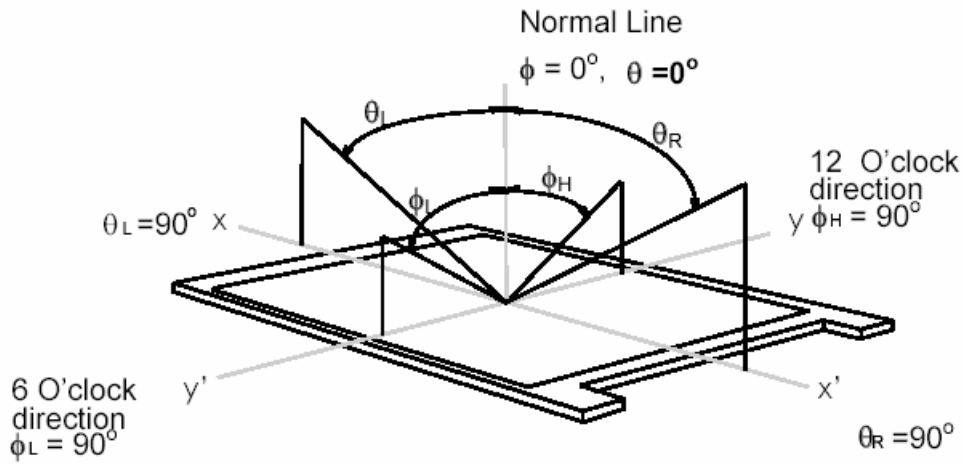

AUO Confidential For PROMATE Internal Use Only / 2009/6/17



### 3. Functional Block Diagram

The following diagram shows the functional block of the 7.0 inch color TFT/LCD module:

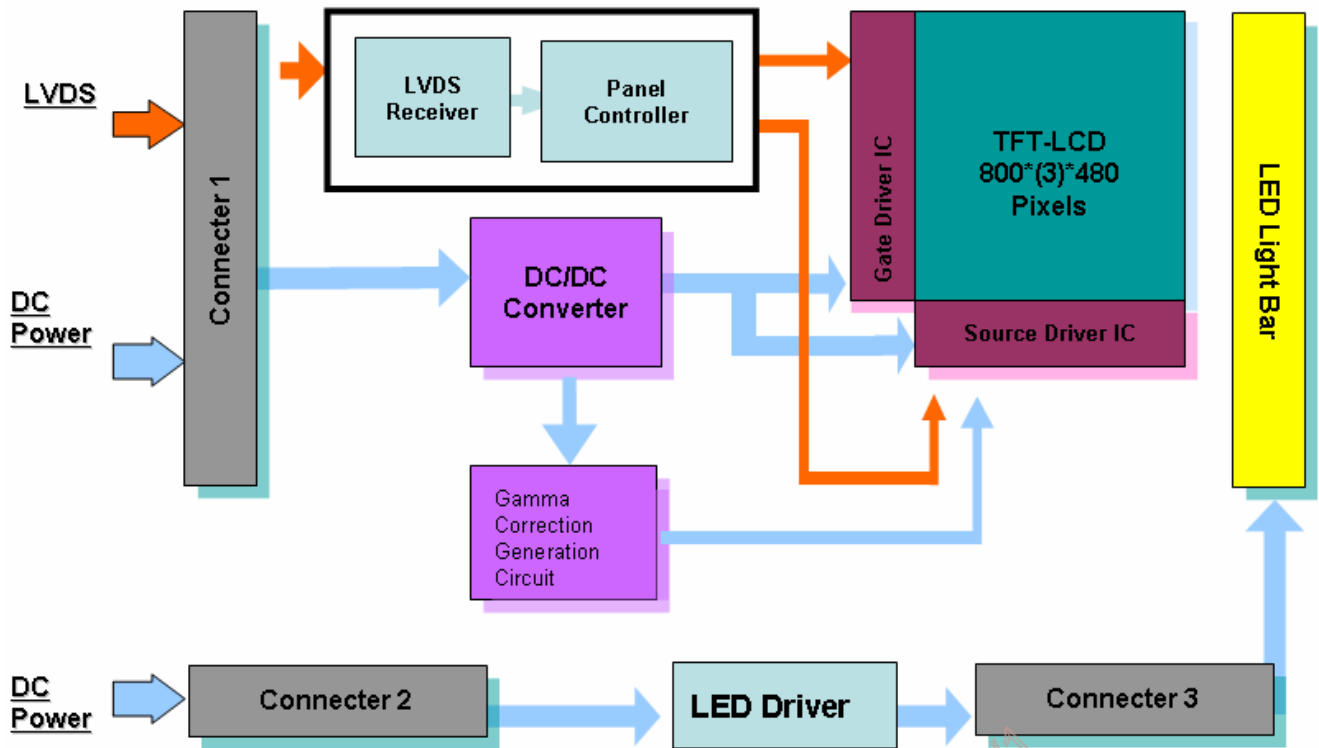

AUO Confidential For PROMATE Internal Use Only / 2009/6/11

## 4. Absolute Maximum Ratings

### 4.1 Absolute Ratings of TFT LCD Module

Item	Symbol	Min	Max	Unit	Conditions
Logic/LCD Drive Voltage	VDD	-0.3	+3.6	[Volt]	

### 4.2 Absolute Ratings of Environment

Item	Symbol	Min	Max	Unit
Operating Temperature	TOP	-30	+85	[°C]
Operation Humidity	HOP	5	90	[%RH]
Storage Temperature	TST	-30	+85	[°C]
Storage Humidity	HST	5	90	[%RH]

Note: Maximum Wet-Bulb should be 39°C and no condensation.

AUO Confidential For PROMATE Internal Use Only / 2009/6/17

## 5. Electrical Characteristics

### 5.1 TFT LCD Module

#### 5.1.1 Power Specification

Symbol	Parameter	Min	Typ	Max	Units	Remark
VDD	Logic/LCD Drive Voltage	3.0	3.3	3.6	[Volt]	± 10%
I <sub>VDD</sub>	VDD Current	-	240	260	[mA]	64 Gray Bar Pattern (VDD=3.3V, at 60Hz)
I <sub>rush</sub>	LCD Inrush Current	-	-	3	[A]	Note 1
P <sub>VDD</sub>	VDD Power	-	0.8	0.96	[Watt]	64 Gray Bar Pattern (VDD=3.3V, at 60Hz)

Note 1: Measurement condition:

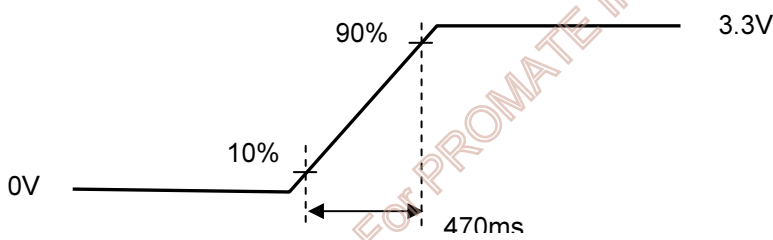
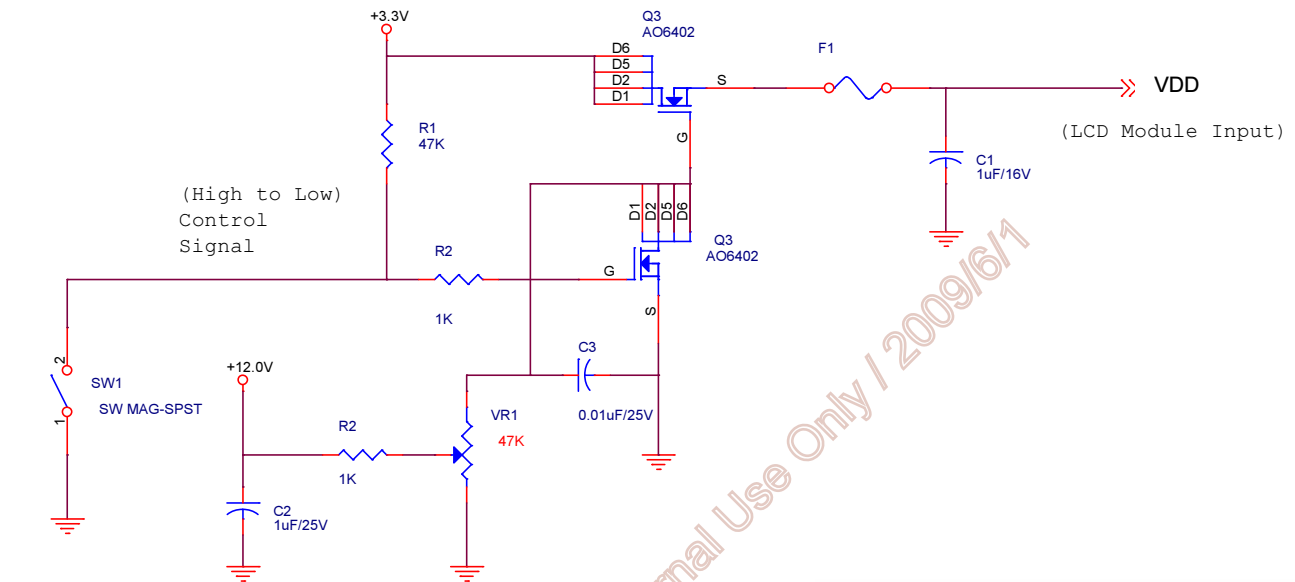

VDD rising time



64 Gray pattern

### 5.1.2 Signal Electrical Characteristics

Input signals shall be low or Hi-Z state when VDD is off.

Symbol	Item	Min.	Typ.	Max.	Unit	Remark
VTH	Differential Input High Threshold	-	-	100	[mV]	VICM=1.2V
VTL	Differential Input Low Threshold	-100	-	-	[mV]	VICM=1.2V
VID	Input Differential Voltage	100	400	600	[mV]	
VICM	Differential Input Common Mode Voltage	1.1		1.6	[V]	VTH/VTL=±100mV

Note: LVDS Signal Waveform.

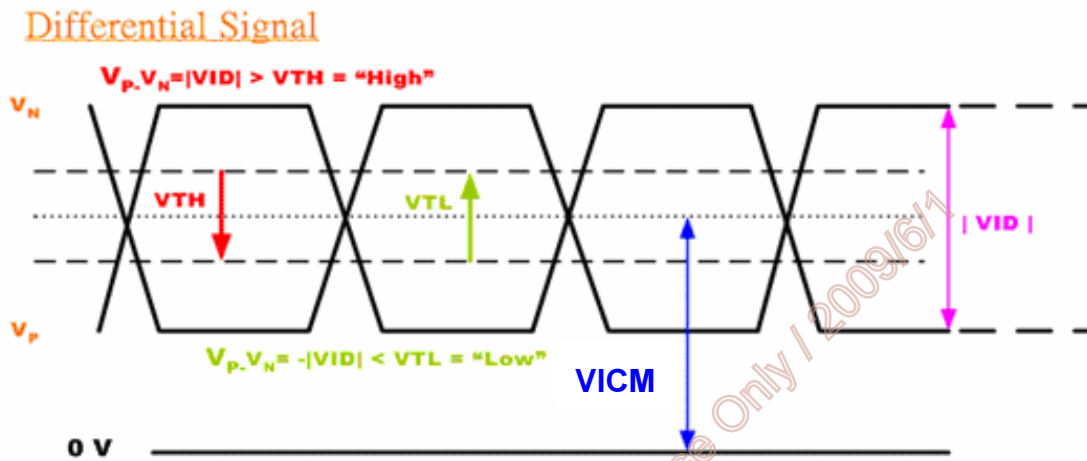

## 5.2 Backlight Unit

### 5.2.1 Parameter guideline for LED

Following characteristics are measured under a stable condition using an inverter at 25°C (Room Temperature):

Symbol	Parameter	Min.	Typ.	Max.	Unit	Remark
<b>VCC</b>	Input Voltage	10.8	12	12.6	[Volt]	
<b>Ivcc</b>	Input Current	-	0.24	-	[A]	100% analog dimming
<b>P<sub>VCC</sub></b>	Power Consumption	-	2.88	3.6	[Watt]	100% analog dimming
<b>I<sub>rush LED</sub></b>	Inrush Current	-	-	3.0	[A]	at rising time=470us
<b>Dimming</b>	Swing Voltage	0.3		5.0	V	Analog Dimming
	Brightness percentage	25		100	%	
<b>I<sub>F</sub></b>	LED Forward Current	-	80	84	mA	Ta = 25°C
<b>V<sub>F</sub></b>	LED Forward Voltage	-	35	-	Volt	I <sub>F</sub> = 80mA, Ta = -30°C
		-	32	36.5	Volt	I <sub>F</sub> = 80mA, Ta = 25°C
		-	30.5	-		I <sub>F</sub> = 80mA, Ta = 85°C
<b>P<sub>LED</sub></b>	LED Power Consumption	-	2.56	-	Watt	I <sub>F</sub> = 80mA, Ta = 25°C
<b>Operation Lifetime</b>		50,000			Hrs	I <sub>F</sub> =80mA, Ta= 25°C

Note 1: Ta means ambient temperature of TFT-LCD module.

Note 2: VCC, Ivcc, P<sub>VCC</sub>, I<sub>rush LED</sub> are defined for LED B/L.(100% analog dimming)

Note 3: I<sub>F</sub>, V<sub>F</sub>, P<sub>LED</sub> are defined for LED Light Bar. There is one LED channel (AN1-CA1) in back light unit.

Note 4: If G070VW01 V0 module is driven by high current or at high ambient temperature & humidity condition. The operating life will be reduced.

Note 5: Operating life means brightness goes down to 50% initial brightness. Typical operating life time is estimated data.

AUO Confidential For PROMATE Internal Use Only / 2009/05/17

## 6. Signal Characteristic

### 6.1 Pixel Format Image

Following figure shows the relationship between input signal and LCD pixel format.

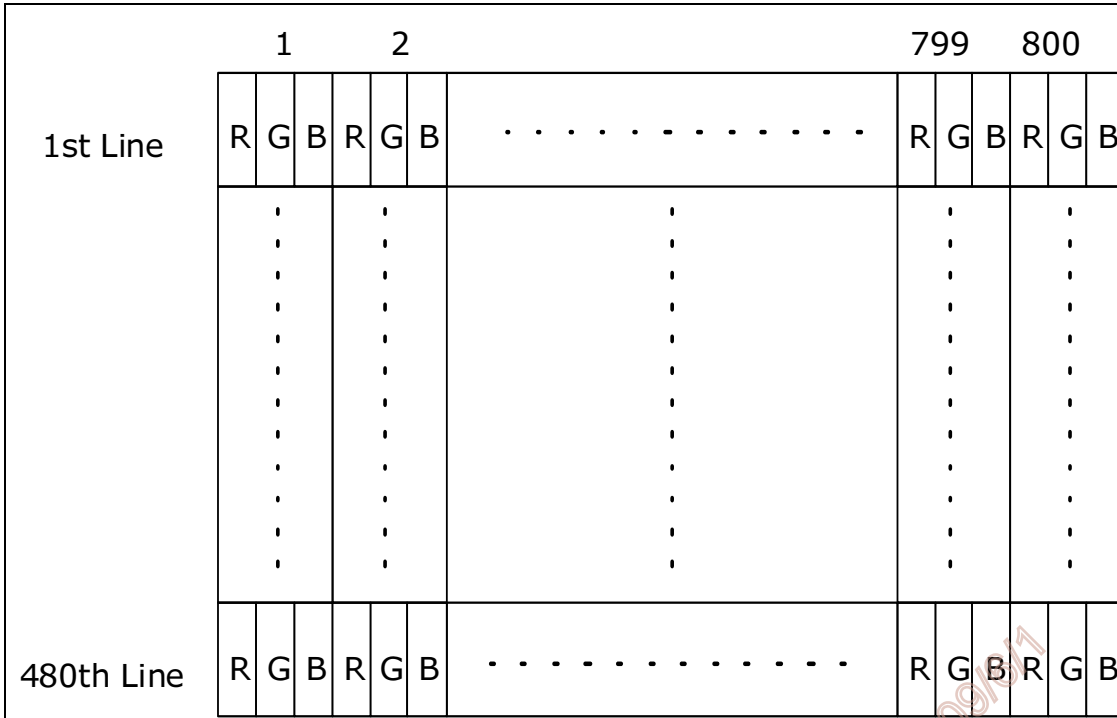

AUO Confidential For PROMATE Internal Use Only / 2009/07

## 6.2 Signal Description

LVDS is a differential signal technology for LCD interface and high speed data transfer device. The connector pin definition is as below.

Pin No.	Symbol	Description
1	VDD	Power Supply, 3.3V (typical)
2	VDD	Power Supply, 3.3V (typical)
3	UD	Vertical Reverse Scan Control, When UD=High or NC → Normal Mode. When UD=Low → Vertical Reverse Scan. <small>Note</small>
4	LR	Horizontal Reverse Scan Control, When LR=High or NC → Normal Mode. When LR=Low → Horizontal Reverse Scan. <small>Note</small>
5	RxIN1-	LVDS differential data input Pair 0
6	RxIN1+	
7	GND	Ground
8	RxIN2-	LVDS differential data input Pair 1
9	RxIN2+	
10	GND	Ground
11	RxIN3-	LVDS differential data input Pair 2
12	RxIN3+	
13	GND	Ground
14	RxCLKIN-	LVDS differential Clock input Pair
15	RxCLKIN+	
16	GND	Ground
17	SEL 68	LVDS 6/8 bit select function control, Low or NC → 6 Bit Input Mode. High → 8 Bit Input Mode. <small>Note</small>
18	NC	NC
19	RxIN4-	LVDS differential data input Pair 3. Must be tied to Ground in 6 bit input mode.
20	RxIN4+	

Note : “Low” stands for 0V. “High” stands for 3.3V. “NC” stands for “No Connected.”

## 6.3 Scanning Direction

The following figures show the image seen from the front view. The arrow indicates the direction of scan.

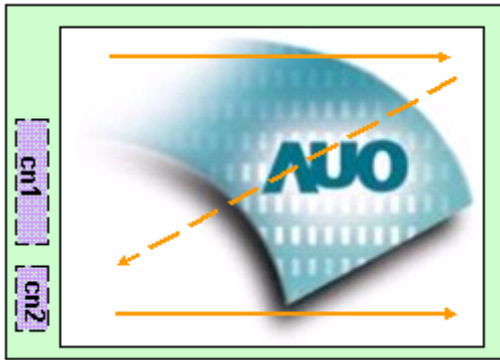

Fig. 1

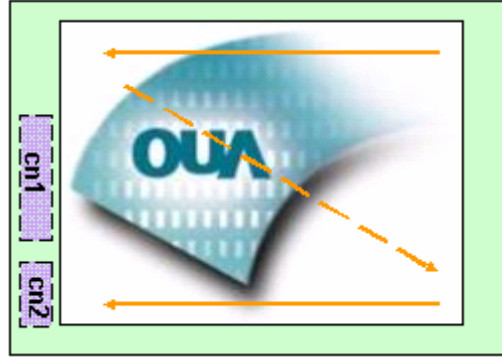

Fig. 2

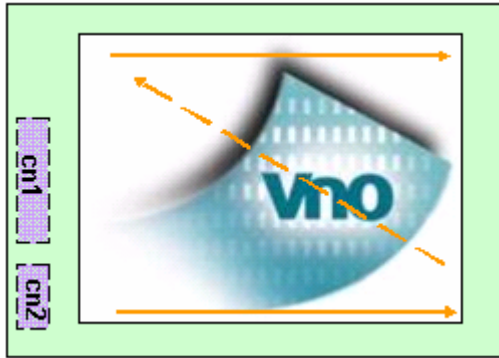

Fig. 3

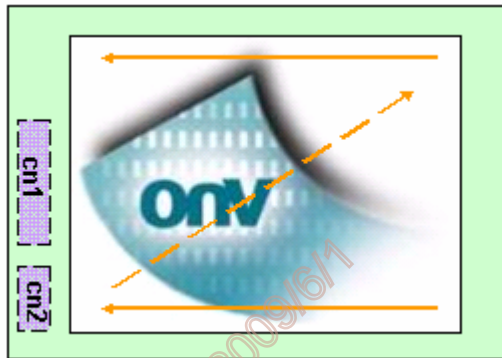

Fig. 4

Fig. 1 Normal scan (Pin3, UD = High or NC ; Pin4, RL = High or NC)

Fig. 2 Reverse scan (Pin3, UD = High or NC ; Pin4, RL = Low)

Fig. 3 Reverse scan (Pin3, UD = Low ; Pin4, RL = High or NC)

Fig. 4 Reverse scan (Pin3, UD = Low ; Pin4, RL = Low)

AUO Confidential For PROMATE Internal Use Only / 2009/6/1



## 6.4 The Input Data Format

### 6.4.1 SEL68

**SEL68 = "Low" or "NC" for 6 bits LVDS Input**

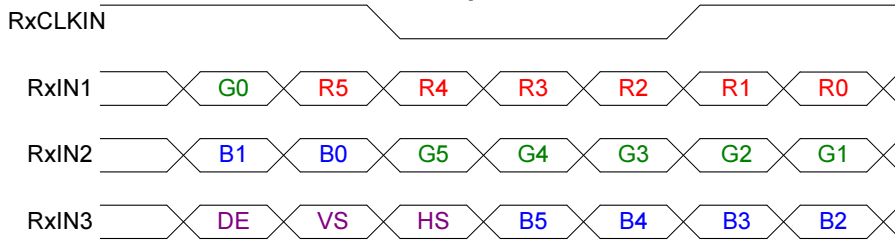

**SEL68 = "High" for 8 bits LVDS Input**

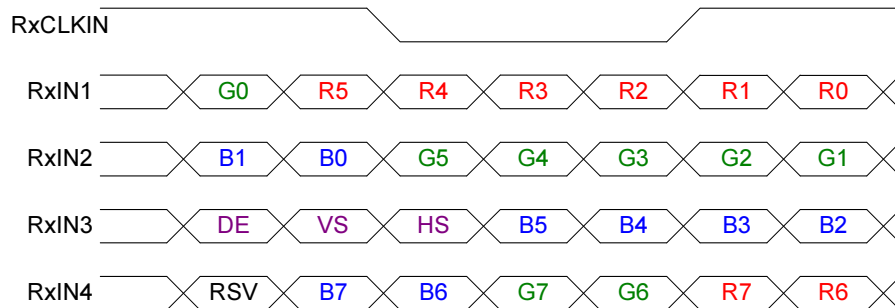

**Note1:** Please follow PSWG.

**Note2:** R/G/B data 7:MSB, R/G/B data 0:LSB

Signal Name	Description	Remark
R7	Red Data 7 (MSB)	Red-pixel Data Each red pixel's brightness data consists of these 8 bits pixel data.
R6	Red Data 6	
R5	Red Data 5	
R4	Red Data 4	
R3	Red Data 3	
R2	Red Data 2	
R1	Red Data 1	
R0	Red Data 0 (LSB)	
G7	Green Data 7 (MSB)	Green-pixel Data Each green pixel's brightness data consists of these 8 bits pixel data.
G6	GreenData 6	
G5	GreenData 5	
G4	GreenData 4	
G3	GreenData 3	
G2	GreenData 2	
G1	GreenData 1	
G0	GreenData 0 (LSB)	
B7	Blue Data 7 (MSB)	Blue-pixel Data Each blue pixel's brightness data consists of these 8 bits pixel data.
B6	Blue Data 6	
B5	Blue Data 5	
B4	Blue Data 4	
B3	Blue Data 3	
B2	Blue Data 2	
B1	Blue Data 1	
B0	Blue Data 0 (LSB)	
RxCLKIN+ RxCLKIN-	LVDS Clock Input	
DE	Display Enable	
VS	Vertical Sync	
HS	Horizontal Sync	

Note: Output signals from any system shall be low or Hi-Z state when VDD is off.

## 6.5 Interface Timing

### 6.5.1 Timing Characteristics

DE mode only

Parameter	Symbol	Min.	Typ.	Max.	Unit	Condition
Clock frequency	$1/T_{\text{Clock}}$	27	33.3	39.4	MHz	
Vertical Section	Period	$T_V$	490	508	530	$T_H$
	Active	$T_{VD}$	480	480	480	
	Blanking	$T_{VB}$	8	28	50	
Horizontal Section	Period	$T_H$	920	1056	1240	$T_{\text{Clock}}$
	Active	$T_{HD}$	800	800	800	
	Blanking	$T_{HB}$	120	256	440	

Note: Frame rate is 60 Hz.  
 Note: DE mode.

### 6.5.2 Input Timing Diagram

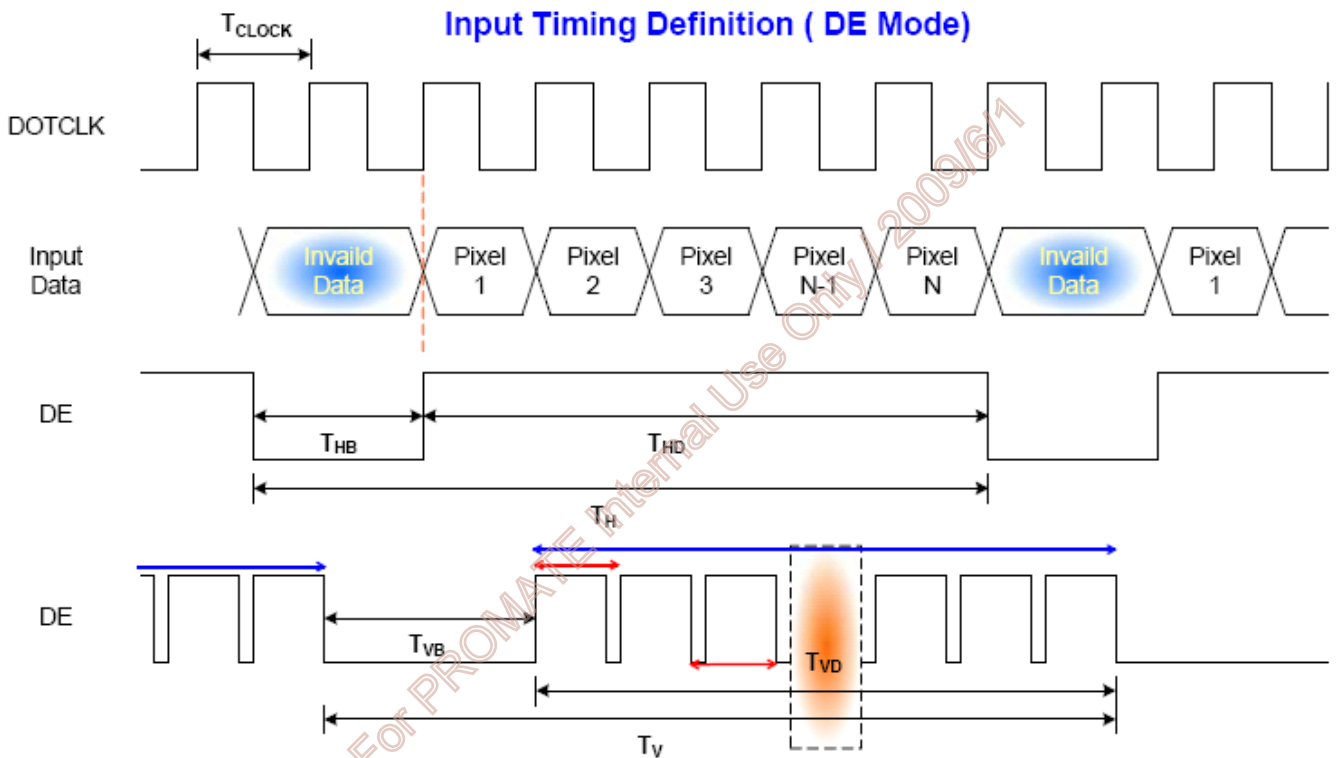

## 6.6 Power ON/OFF Sequence

VDD power and backlight on/off sequence is as below. Interface signals are also shown in the chart. Signals from any system shall be Hi-Z state or low level when VDD is off.

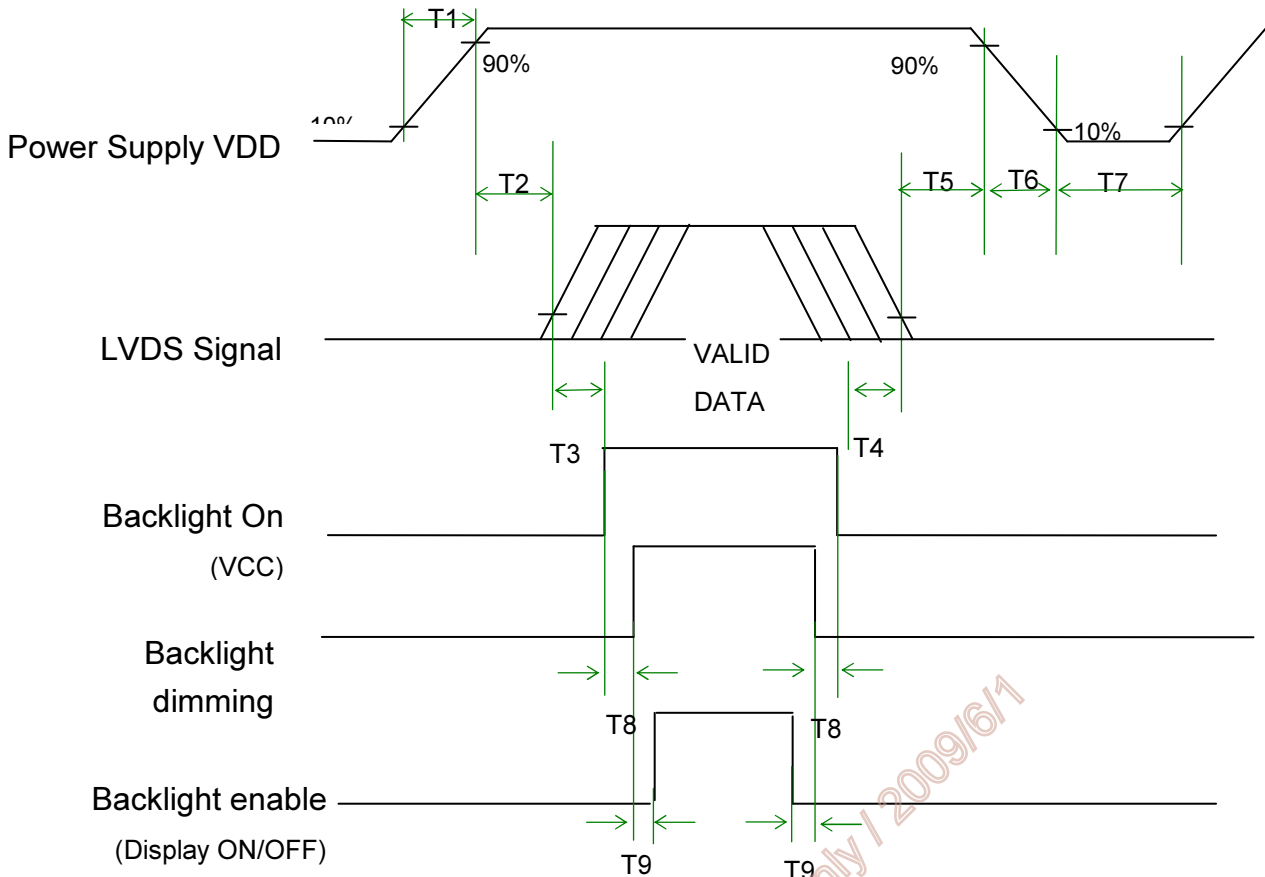

**Power ON/OFF sequence timing**

Parameter	Value			Units
	Min.	Typ.	Max.	
T1	0.5	-	10	ms
T2	0	40	50	ms
T3	200	-	-	ms
T4	200	-	-	ms
T5	0	16	50	ms
T6	0	-	10	ms
T7	1000	-	-	ms
T8	10	-	-	ms
T9	10	-	-	ms

The above on/off sequence should be applied to avoid abnormal function in the display. Please make sure to turn off the power when you plug the cable into the input connector or pull the cable out of the connector.

## 7. Connector & Pin Assignment

Physical interface is described as for the connector on module. These connectors are capable of accommodating the following signals and will be following components.

### 7.1 TFT LCD Signal (CN1): LVDS Connector

Connector Name / Designation	Signal Connector
Manufacturer	STM, Hirose or compatible
Connector Model Number	STM -MSB24013P20HA, Hirose- DF19LA-20P-1H or compatible
Mating Model Number	STM-P24013P20, Hirose-DF19-20S-1C or compatible

Pin No.	Signal Name	Pin No.	Signal Name
1	VDD	2	VDD
3	UD	4	LR
5	RxIN1-	6	RxIN1+
7	GND	8	RxIN2-
9	RxIN2+	10	GND
11	RxIN3-	12	RxIN3+
13	GND	14	RxCKIN-
15	RxCKIN+	16	GND
17	SEL 68	18	NC
19	RxIN4-	20	RxIN4+

### 7.2 LED Backlight Unit (CN2): LED Driver Connector

Connector Name / Designation	LED Driver Connector
Manufacturer	Entery
Connector Model Number	3808K-F04N-02R or compatible
Mating Model Number	H208K-P04N-02B or compatible

Pin #	Symbol	Pin Description
1	GND	GND
2	Display_ON/OFF	+3.3V:ON, 0V:OFF
3	Dimming	Analog Dimming
4	VCC12V	12V Power Input

### 7.3 LED Light Bar Input Connector (CN4):

<b>Manufacturer</b>	Entery or compatible
<b>Connector Model Number</b>	H208K-P02N-02B or compatible
<b>Mating Connector Model Number</b>	3808K-F02N-02R or compatible

Pin #	Symbol	Pin Description
1	AN1	LED anode
2	CA1	LED cathode

Pin #	Symbol	Cable color
1	AN1	Red
2	CA1	Black

### 8. Reliability Test Criteria

Items	Required Condition	Note
Temperature Humidity Bias	40□/90%,300 hours	
High Temperature Operation	85□,300 hours	
Low Temperature Operation	-30□,300 hours	
Hot Storage	85□,300 hours	
Cold Storage	-30□,300 hours	
Thermal Shock Test	-20□/30 min ,60□/30 min ,100cycles	
Shock Test (Non-Operating)	50G,20ms,Half-sine wave, ( ±X, ±Y, ±Z)	
Vibration Test (Non-Operating)	1.5G, (10~200Hz, P-P) 30 mins/axis (X, Y, Z)	
On/off test	On/10 sec, Off/10 sec, 30,000 cycles	
ESD	Contact Discharge: ± 8KV, 150pF(330Ω ) 1sec, 8 points, 25 times/ point Air Discharge: ± 15KV, 150pF(330Ω ) 1sec, 8 points, 25 times/ point	Note 1

Note1: According to EN61000-4-2, ESD class B: Some performance degradation allowed. No data lost  
 . Self-recoverable. No hardware failures.

## 9. Mechanical Characteristics

### 9.1 LCM Front View

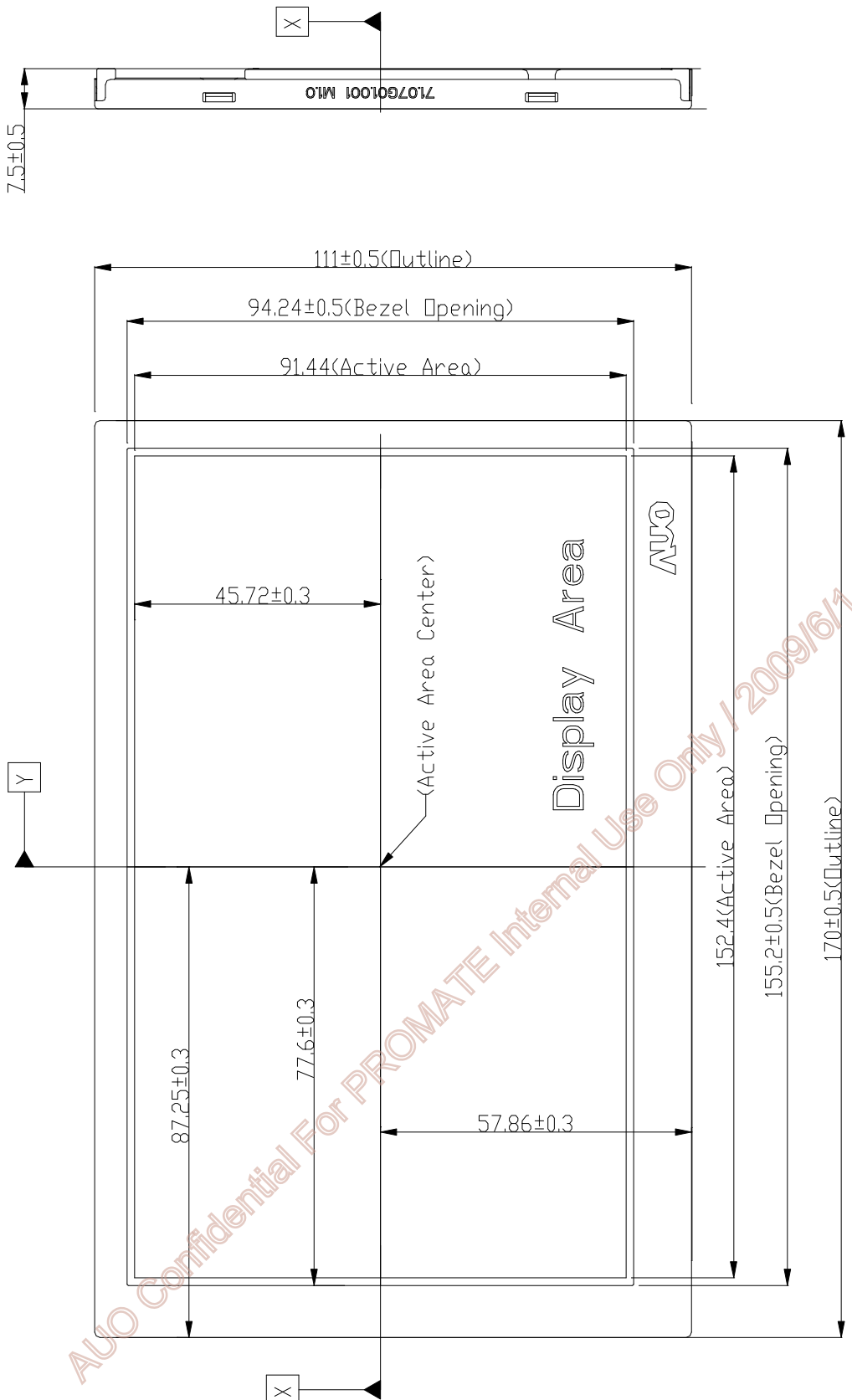

## 9.2 LCM Rear View

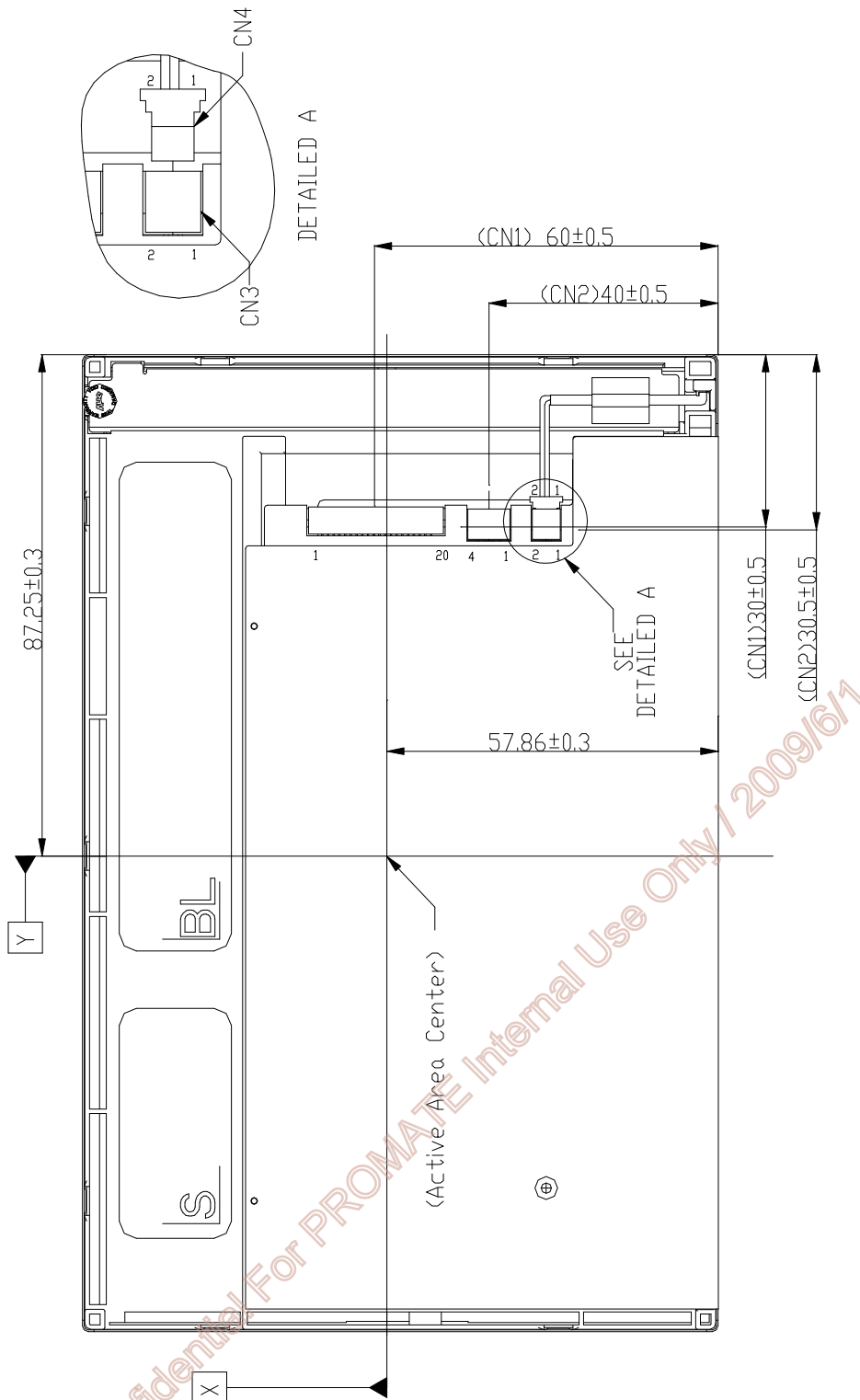

**NOTE:**

- 1.CN1: I/F CONNECTOR IS MSB24013P20HA (STM) OR AU APPROVED EQUIVALENT
- CN2: LED BLU CONNECTOR IS 3808K-F04N-02R (ENTERY) OR AU APPROVED EQUIVALENT
- CN3: LED LIGHT BAR OUTPUT CONNECTOR IS 3808K-F02N-02R (ENTERY) OR AU APPROVED EQUIVALENT
- CN4: LED LIGHT BAR INPUT CONNECTOR IS H208-P02N-02B (ENTERY) OR AU APPROVED EQUIVALENT

## 10. Label and Packaging

### 10.1 Shipping Label (on the rear side of TFT-LCD display)

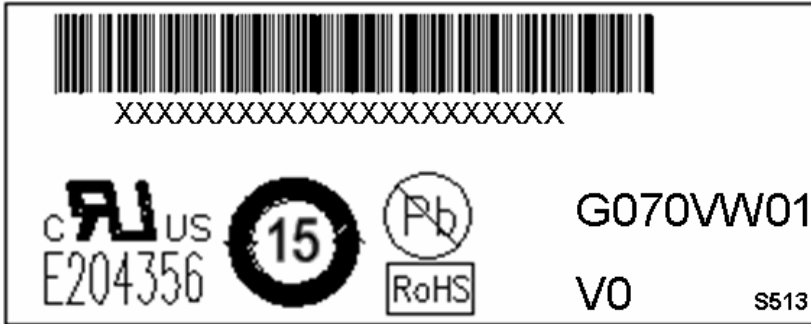

### 10.2 Carton Package

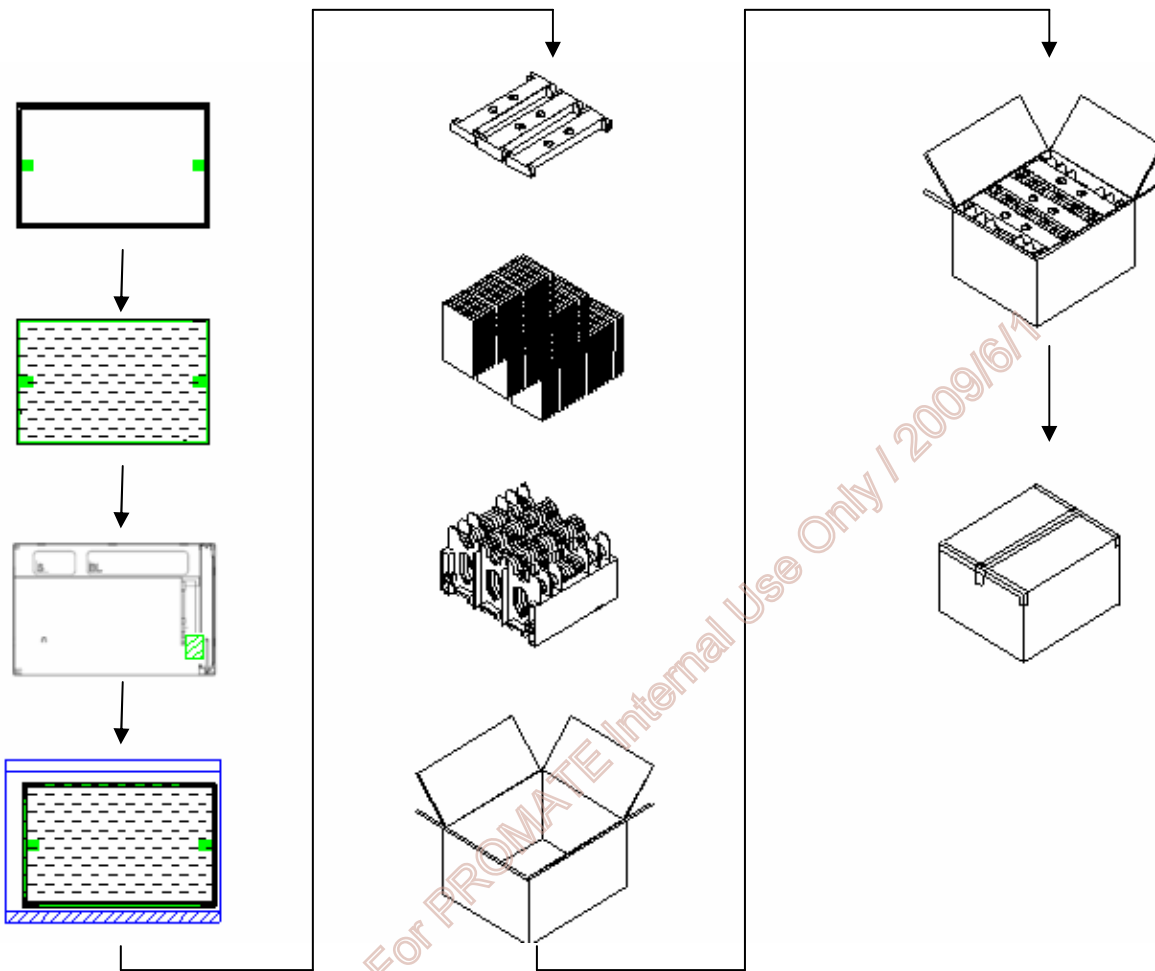

Note:

1. Max. Capacity: 60pcs LCD Modules / per carton
2. Max. Weight: 14.4 kg / per carton
3. The outside dimension of carton is 434(L) mm x 377(W) mm x 264(H) mm



## 11 Safety

### 11.1 Sharp Edge Requirements

There will be no sharp edges or corners on the display assembly that could cause injury.

### 11.2 Materials

#### 11.2.1 Toxicity

There will be no carcinogenic materials used anywhere in the display module. If toxic materials are used, they will be reviewed and approved by the responsible AUO toxicologist.

#### 11.2.2 Flammability

All components including electrical components that do not meet the flammability grade UL94-V1 in the module will complete the flammability rating exception approval process.

The pRxINted circuit board will be made from material rated 94-V1 or better. The actual UL flammability rating will be pRxINted on the pRxINted circuit board.

### 11.3 Capacitors

If any polarized capacitors are used in the display assembly, provisions will be made to keep them from being inserted backwards.

### 11.4 National Test Lab Requirement

The display module will satisfy all requirements for compliance to:

**UL 1950, First Edition**

U.S.A. Information Technology Equipment

AUO Confidential For PROMATE Internal Use Only / 2009/6/17