



Digital Tri-axis Gyroscope/ Tri-axis Accelerometer Specifications

PART NUMBER

KXG03-1034

Rev. 2.0

14-Feb-17

Product Description

KXG03-1034 is a 6 Degrees-of-Freedom inertial sensor system that features digital outputs accessed through I²C or SPI communication. The KXG03 sensor consists of a tri-axial micro machined gyroscope plus a tri-axial accelerometer and an KXG03 packaged in a 3 x 3 x 0.9 mm 16-pin Land Grid Array (LGA) package. The KXG03 is realized in standard CMOS technology and features flexible user programmable gyroscope full scale ranges of ± 256 , ± 512 , ± 1024 , and $\pm 2048^\circ/\text{sec}$ and user-programmable $\pm 2g/\pm 4g/\pm 8g/\pm 16g$ full scale range for the accelerometer. An auxiliary I²C master serial interface exists for communication with up to 2 other sensors to access data that can be accumulated in an internal 1024-byte FIFO buffer and transmitted to the application processor. In addition, the KXG03 has an embedded temperature sensor.

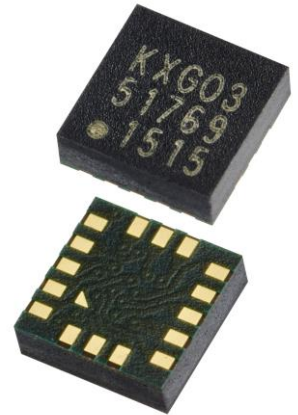

During operation, the gyroscope sensor elements are forced into vibration. When angular velocities are applied about the sensing axes, vibration is transferred to sensing elements, causing capacitance changes at the sensor electrodes. Acceleration sensing is based on the principle of a differential capacitance arising from acceleration-induced motion of the sense element, which utilizes common mode cancellation to decrease errors from process variation, temperature, and environmental stress. Capacitance changes are amplified and converted into digital signals which are processed by a dedicated digital signal processing unit. The digital signal processor applies filtering, bias and sensitivity adjustment, as well as temperature compensation. The DSP also feeds back the driving signal to ensure the proper sensor excitation.

The KXG03 series is designed to strike a balance between current consumption and noise performance with excellent bias stability over temperature. These sensors can accept supply and digital communication voltages between 1.8V and 3.6V.

	Digital Tri-axis Gyroscope/ Tri-axis Accelerometer Specifications	PART NUMBER KXG03-1034 Rev. 2.0 14-Feb-17
---	--	--

Features

- 3 x 3 x 0.9 mm LGA
- User-selectable low power or high resolution mode
- User selectable gyroscope full scale ranges of:
 - ±256 deg/s
 - ±512 deg/s
 - ±1024 deg/s
 - ±2048 deg/s
- User selectable accelerometer full scale ranges of:
 - ±2g
 - ±4g
 - ±8g
 - ±16g
- Temperature sensor with min measurement range of -40 C to +85 C with 16-bit output
- User-selectable Output Data Rate (ODR) up to 51200Hz
- 1024 byte FIFO buffer
- Wake-up and Back-to-sleep functions
- Auxiliary I2C master interface to control up to 2 auxiliary sensors
- Independent Output Data Rate (ODR) : Over Sampling Rate (OSR) control for accelerometer
- User-configurable wake-up function
- Digital I²C up to 3.4MHz
- Digital SPI up to 10MHz
- Lead-free Solderability
- Excellent Temperature Performance
- High Shock Survivability
- Factory Programmed Offset and Sensitivity
- Self-test Function

	Digital Tri-axis Gyroscope/ Tri-axis Accelerometer Specifications	PART NUMBER KXG03-1034 Rev. 2.0 14-Feb-17
---	--	--

Table of Contents

PRODUCT DESCRIPTION	1
FEATURES	2
TABLE OF CONTENTS	3
FUNCTIONAL DIAGRAM	7
PRODUCT SPECIFICATIONS	8
GYROSCOPE MECHANICAL	8
ACCELEROMETER MECHANICAL	9
TEMPERATURE SENSOR	9
ELECTRICAL	10
<i>Accelerometer Start-up time versus ODR profile:</i>	11
<i>Accelerometer Low Power Mode Current versus ODR profile:</i>	11
<i>Power-On Procedure</i>	12
ENVIRONMENTAL	13
SOLDERING	13
APPLICATION SCHEMATIC	14
PIN DESCRIPTIONS	15
PACKAGE DIMENSIONS AND ORIENTATION:	16
<i>Dimensions</i>	16
<i>Orientation</i>	17
DIGITAL INTERFACE	18
I ² C SERIAL INTERFACE	18
<i>I²C Operation</i>	19
<i>Writing to 8-bit Register</i>	20
<i>Reading from 8-bit Register</i>	21
<i>Data Transfer Sequences</i>	22
<i>HS-mode</i>	23
<i>I²C Timing Diagram</i>	24
<i>I²C Timing Specifications</i>	24
<i>Auxiliary I²C Operation</i>	25
<i>Auxiliary I²C Host Mode</i>	25
<i>Auxiliary I²C Bypass Mode</i>	25
<i>Internal Pull-up Resistor</i>	25
SPI COMMUNICATIONS	26
<i>4-Wire SPI Interface</i>	26
<i>4-Wire SPI Timing Diagram</i>	27
<i>4-Wire Read and Write Registers</i>	28
POWER MODES	29



Digital Tri-axis Gyroscope/ Tri-axis Accelerometer Specifications

PART NUMBER

KXG03-1034

Rev. 2.0

14-Feb-17

OFF MODE	29
INITIAL STARTUP.....	29
STAND-BY MODE	30
ACTIVE WUF MODE.....	30
ACTIVE WAKE AND SLEEP MODE.....	30
EMBEDDED WAKE-UP AND BACK-TO-SLEEP FUNCTION	31
EMBEDDED REGISTERS.....	32
GYROSCOPE OUTPUTS	33
ACCELEROMETER OUTPUTS	33
TEMPERATURE SENSOR OUTPUTS	34
REGISTER DESCRIPTIONS.....	35
TEMP_OUT.....	35
GYRO_XOUT.....	35
GYRO_YOUT.....	35
GYRO_ZOUT.....	35
ACCEL_XOUT.....	36
ACCEL_YOUT.....	36
ACCEL_ZOUT.....	36
AUX1_OUT	36
AUX2_OUT	37
WAKE_CNT.....	37
SLEEP_CNT	37
BUF_SMPLEV	38
BUF_PAST	38
AUX_STATUS.....	38
WHO_AM_I.....	40
SN.....	40
STATUS1.....	40
INT1_SRC1	42
INT1_SRC2	43
INT1_L.....	44
STATUS2.....	44
INT2_SRC1	45
INT2_SRC2	47
INT2_L.....	48
ACCEL_ODR_WAKE.....	48
ACCEL_ODR_SLEEP	49
ACCEL_CTL	51
GYRO_ODR_WAKE.....	51
GYRO_ODR_SLEEP	53
STDBY.....	55



Digital Tri-axis Gyroscope/ Tri-axis Accelerometer Specifications

PART NUMBER

KXG03-1034

Rev. 2.0

14-Feb-17

CTL_REG_1.....	56
INT_PIN_CTL.....	57
INT_PIN1_SEL.....	58
INT_PIN2_SEL.....	59
INT_MASK1.....	60
INT_MASK2.....	61
FSYNC_CTL.....	61
WAKE_SLEEP_CTL1.....	62
WAKE_SLEEP_CTL2.....	63
WUF_TH.....	63
WUF_COUNTER.....	64
BTS_TH.....	64
BTS_COUNTER.....	64
AUX_I2C_CTL_REG.....	65
AUX_I2C_SAD1.....	66
AUX_I2C_REG1.....	66
AUX_I2C_CTL1.....	66
AUX_I2C_BIT1.....	66
AUX_I2C_ODR1_W.....	67
AUX_I2C_ODR1_S.....	68
AUX_I2C_SAD2.....	68
AUX_I2C_REG2.....	69
AUX_I2C_CTL2.....	69
AUX_I2C_BIT2.....	69
AUX_I2C_ODR2_W.....	69
AUX_I2C_ODR2_S.....	71
BUF_WMITH_L.....	71
BUF_WMITH_H.....	72
BUF_TRIGTH_L.....	72
BUF_TRIGTH_H.....	72
BUF_CTL2.....	73
BUF_CTL3.....	73
BUF_CTL4.....	74
BUF_EN.....	74
BUF_STATUS.....	76
BUF_CLEAR.....	76
BUF_READ.....	76
SAMPLE BUFFER FEATURE DESCRIPTION	77
FIFO MODE.....	77
STREAM MODE.....	77
TRIGGER MODE.....	78
FILO MODE.....	78

	<h2 style="text-align: center;">Digital Tri-axis Gyroscope/ Tri-axis Accelerometer Specifications</h2>	<p style="text-align: center;">PART NUMBER KXG03-1034 Rev. 2.0 14-Feb-17</p>
---	--	---

BUFFER OPERATION	78
SYNCHRONIZING BUFFER UPDATES TO EXTERNAL CLOCK	84
EXTERNAL INTERRUPT SAMPLING	84
INPUT DATA SELECT	84
DATA ORDER	84
BUFFER UPDATE RATE	85
BUFFER SIZE DESCRIPTION	85
BUFFER FULL INTERRUPT (BFI)	86
SMP_PAST COUNTER (PACKETS LOST SINCE BFI)	87
WATERMARK (WMI)	87
BUFFER LEVEL	87
CHANGING BUFFER CONFIGURATIONS	88
CHANGING SENSOR CONFIGURATIONS	88
CLEARING THE BUFFER	88
BUFFER READS	88
REVISION HISTORY	89
APPENDIX	89



Digital Tri-axis Gyroscope/ Tri-axis Accelerometer Specifications

PART NUMBER
KXG03-1034
 Rev. 2.0
 14-Feb-17

Functional Diagram

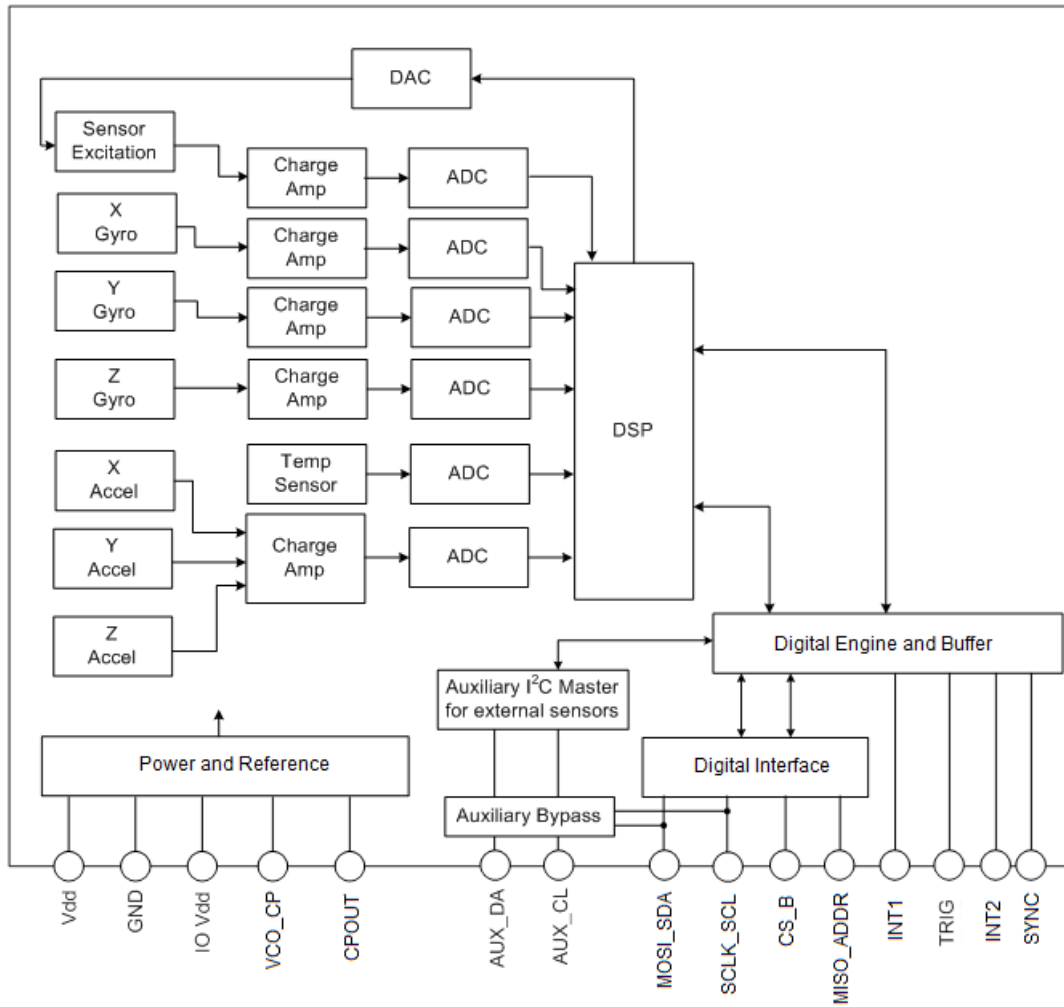



Digital Tri-axis Gyroscope/ Tri-axis Accelerometer Specifications

PART NUMBER

KXG03-1034

Rev. 2.0

14-Feb-17

Product Specifications

Gyroscope Mechanical

(Specifications are for operation at VDD = 2.5V and T = 25°C unless stated otherwise)

Parameters		Units	Min	Typical	Max
Operating Temperature Range		°C	-40	-	85
Zero Rate Output, Digital		counts		0	
Zero Rate Output Stability		± % of FS		1	
Zero Rate Output Variation over Temperature		± dps / °C		0.4	
Sensitivity (16-bit) ¹	RSEL1 = 0, RSEL0 = 0, ±256 deg/sec	counts/deg/sec		128	
	RSEL1 = 0, RSEL0 = 1, ±512 deg/sec			64	
	RSEL1 = 1, RSEL0 = 0, ±1024 deg/sec			32	
	RSEL1 = 1, RSEL0 = 1, ±2048 deg/sec			16	
Sensitivity Variation over Temperature		± % / °C		0.04	
Noise Density		deg/sec/√Hz		0.03	
Output Noise (10 Hz BW)		dps-rms		0.096	
Non-Linearity		% of FS		0.5	
Cross Axis Sensitivity		± %		1	
Bandwidth ²		Hz	10		160

Table 1: Gyroscope Mechanical Specifications

Notes:

1. Resolution and rotation rate ranges are user selectable.
2. User selectable via control register.



Digital Tri-axis Gyroscope/ Tri-axis Accelerometer Specifications

PART NUMBER

KXG03-1034

Rev. 2.0

14-Feb-17

Accelerometer Mechanical

(Specifications are for operation at VDD = 2.5V and T = 25°C unless stated otherwise)

Parameters	Units	Min	Typical	Max	
Operating Temperature Range	°C	-40	-	85	
Zero-g Offset	mg	-	±25	±125	
Zero-g Offset Variation from RT over Temp.	± mg/ °C		0.25		
Sensitivity (16-bit) ¹	GSEL1=1, GSEL0=1 (± 2g)	counts/g	15565	16384	17203
	GSEL1=0, GSEL0=0 (± 4g)		7782	8192	8602
	GSEL1=0, GSEL0=1 (± 8g)		3891	4096	4301
	GSEL1=1, GSEL0=0 (± 16g)		1946	2048	2150
Sensitivity Variation from RT over Temp.	± % / °C		0.01 (xy) 0.03 (z)		
Self-Test Output	g		0.5		
Mechanical Resonance (-3dB) ²	Hz		3500 (xy) 1800 (z)		
Non-Linearity	% of FS		0.5		
Cross Axis Sensitivity	%		2		
Noise Density	$\mu\text{g} / \sqrt{\text{Hz}}$		175		
Bandwidth (-3dB)	Hz		ODR/2		

Table 2: Accelerometer Mechanical Specifications

Notes:

1. Resolution and acceleration ranges are user selectable.
2. Resonance as defined by the damped mechanical sensor.

Temperature Sensor

(Specifications are for operation at VDD = 2.5V and T = 25 °C unless stated otherwise)

Parameters	Units	Min	Typical	Max
Operating Temperature Range	°C	-40	-	85
Output Accuracy	± °C		3	
Sensitivity (16-bit digital)	counts/ °C		128	

Table 3: Temperature Sensor Specifications



Digital Tri-axis Gyroscope/ Tri-axis Accelerometer Specifications

PART NUMBER

KXG03-1034

Rev. 2.0

14-Feb-17

Electrical

(Specifications are for operation at VDD = 2.5V and T = 25 °C unless stated otherwise)

Parameters		Units	Min	Typical	Max
Supply Voltage (VDD)	Operating	V	1.8	2.5	3.6
I/O Pads Supply Voltage (IO_VDD)		V	1.7		VDD
Current Consumption	Operating (gyroscope + accelerometer)	mA		2.1	
	Gyroscope only	mA		1.85	
	Accelerometer only High Res Mode	µA		325	
	Accelerometer only Low Power Mode ⁶	µA		5	
	Standby	µA		1.5	
Output Low Voltage ¹ (VOL)		V	-	-	0.3 * IO_VDD
Output High Voltage (VOH)		V	0.9 * IO_VDD	-	-
Input Low Voltage (VIL)		V	-	-	0.2 * IO_VDD
Input High Voltage (VIH)		V	0.8 * IO_VDD	-	-
Power Up Time (Power on Reset Time) ²		ms			50
Software Reset ⁷		ms			2
Sensor Start-Up Time ³	Gyroscope	ms		80	
	Accelerometer (100Hz)	ms		20	
I ² C Communication Rate ^{4,5}		MHz			3.4
I ² C Address				4E / 4F	
SPI communication Rate		MHz			10

Table 4: Electrical Specifications

Notes:

1. Assuming I²C communication and minimum 1.5kΩ pull-up resistor on SCL and SDA.
2. From OFF to Standby mode after VDD and IO_VDD are valid
3. Time from sensor standby mode to operating mode (GYRO_RUN = 1). Accelerometer time varies with accelerometer Output Data Rate (ODR) per table below.
4. Assuming max bus capacitance load of 20pF.
5. The I²C bus supports Standard-Mode, Fast-Mode and High Speed Mode.
6. Accelerometer only in Low Power Mode current varies with accelerometer Output Data Rate (ODR) and Output Wake-up Function (OWUF) per figure on the next page.
7. Software Reset Time is defined as the time it takes to perform a RAM reboot routine following the setting of the SRST bit to 1 in the CTL_REG_1 register. The SRST bit will remain 1 until the RAM reboot routine is completed.



Digital Tri-axis Gyroscope/ Tri-axis Accelerometer Specifications

PART NUMBER
KXG03-1034
Rev. 2.0
14-Feb-17

Accelerometer Start-up time versus ODR profile:

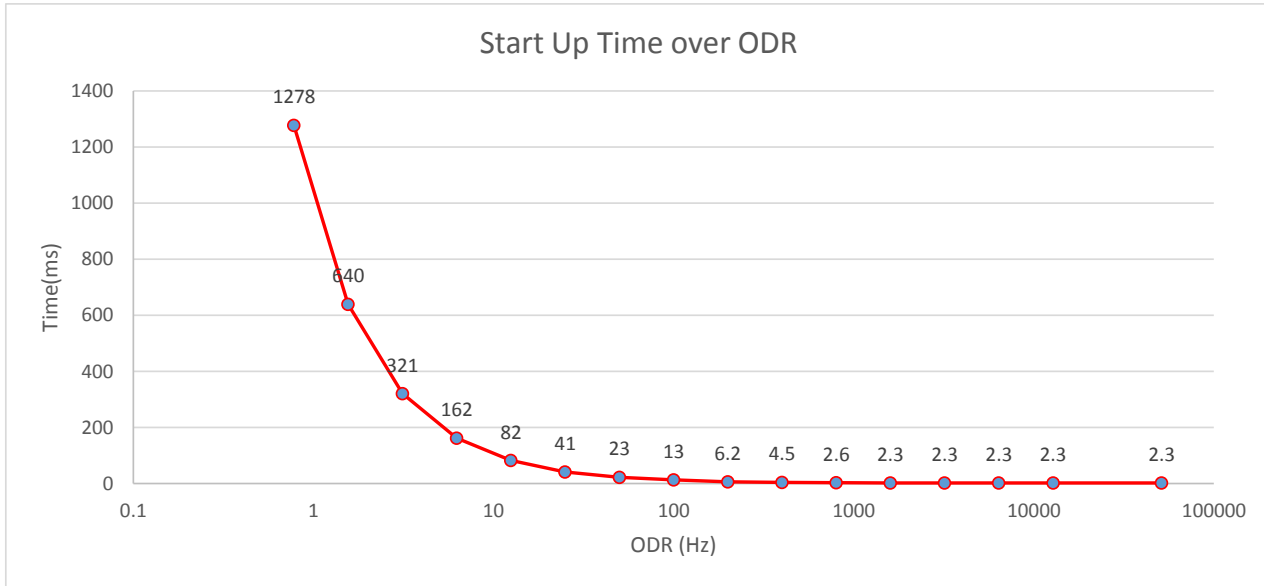

Accelerometer Low Power Mode Current versus ODR profile:

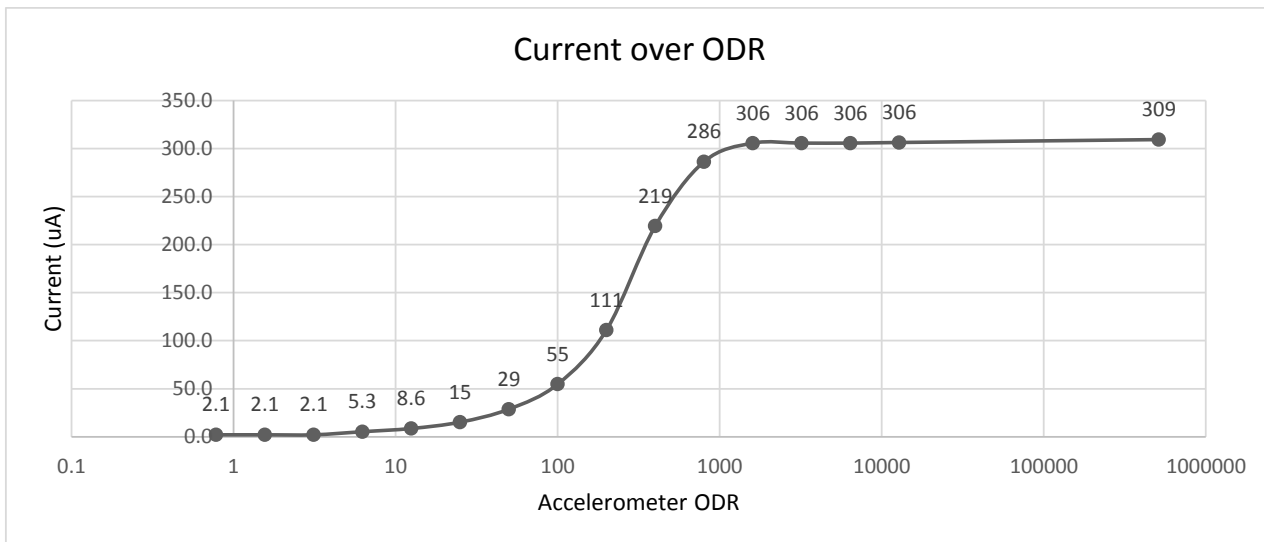

	<p align="center">Digital Tri-axis Gyroscope/ Tri-axis Accelerometer Specifications</p>	<p align="center">PART NUMBER KXG03-1034 Rev. 2.0 14-Feb-17</p>
---	--	--

Power-On Procedure

Proper functioning of power-on reset (POR) is dependent on the specific **VDD**, **VDD_{Low}**, **T_{VDD}** (rise time), and **T_{VDD_OFF}** profile of individual applications. It is recommended to minimize **VDD_{Low}**, and **T_{VDD}**, and maximize **T_{VDD_OFF}**. It is also advised that the **VDD** ramp up time **T_{VDD}** be monotonic. Note that the outputs will not be stable until **VDD** has reached its final value.

- ! *To assure proper POR, the application should be evaluated over the customer specified range of VDD, VDD_{Low}, T_{VDD}, T_{VDD_OFF} and temperature as POR performance can vary depending on these parameters.*

Please refer to Technical Note [TN022 Power-On Procedure](#) for more information.

	Digital Tri-axis Gyroscope/ Tri-axis Accelerometer Specifications	PART NUMBER
		KXG03-1034
		Rev. 2.0
		14-Feb-17

Environmental

Parameters		Units	Min	Typical	Max
Supply Voltage (VDD)	Absolute Limits	V	-0.3	-	3.6
Operating Temperature Range		°C	-40	-	85
Storage Temperature Range		°C	-55	-	150
Mech. Shock (powered and unpowered)		g	-	-	5000 for 0.5 ms 10000 for 0.2 ms
ESD	HBM	V	-	-	2000

Table 5: Environmental Specifications



Caution: ESD Sensitive and Mechanical Shock Sensitive Component, improper handling can cause permanent damage to the device.



These products conform to RoHS Directive 2011/65/EU of the European Parliament and of the Council of the European Union that was issued June 8, 2011. Specifically, these products do not contain any non-exempted amounts of lead, mercury, cadmium, hexavalent chromium, polybrominated biphenyls (PBB) or polybrominated diphenyl ethers (PBDE) above the maximum concentration values (MCV) by weight in any of its homogenous materials. Homogenous materials are “of uniform composition throughout”. The MCV for lead, mercury, hexavalent chromium, PBB, and PBDE is 0.10%. The MCV for cadmium is 0.010%.

Applicable Exemption: *7C-1 - Electrical and electronic components containing lead in a glass or ceramic other than dielectric ceramic in capacitors (piezoelectronic devices) or in a glass or ceramic matrix compound.*



These products are also in conformance with REACH Regulation No 1907/2006 of the European Parliament and of the Council that was issued Dec. 30, 2011. They do not contain any Substances of Very High Concern (SVHC-161) as identified by the European Chemicals Agency as of 17 December 2014.



This product is halogen-free per IEC 61249-2-21. Specifically, the materials used in this product contain a maximum total halogen content of 1500 ppm with less than 900-ppm bromine and less than 900-ppm chlorine.

Soldering

Soldering recommendations are available upon request or from www.kionix.com.



Digital Tri-axis Gyroscope/ Tri-axis Accelerometer Specifications

PART NUMBER
KXG03-1034
 Rev. 2.0
 14-Feb-17

Application Schematic

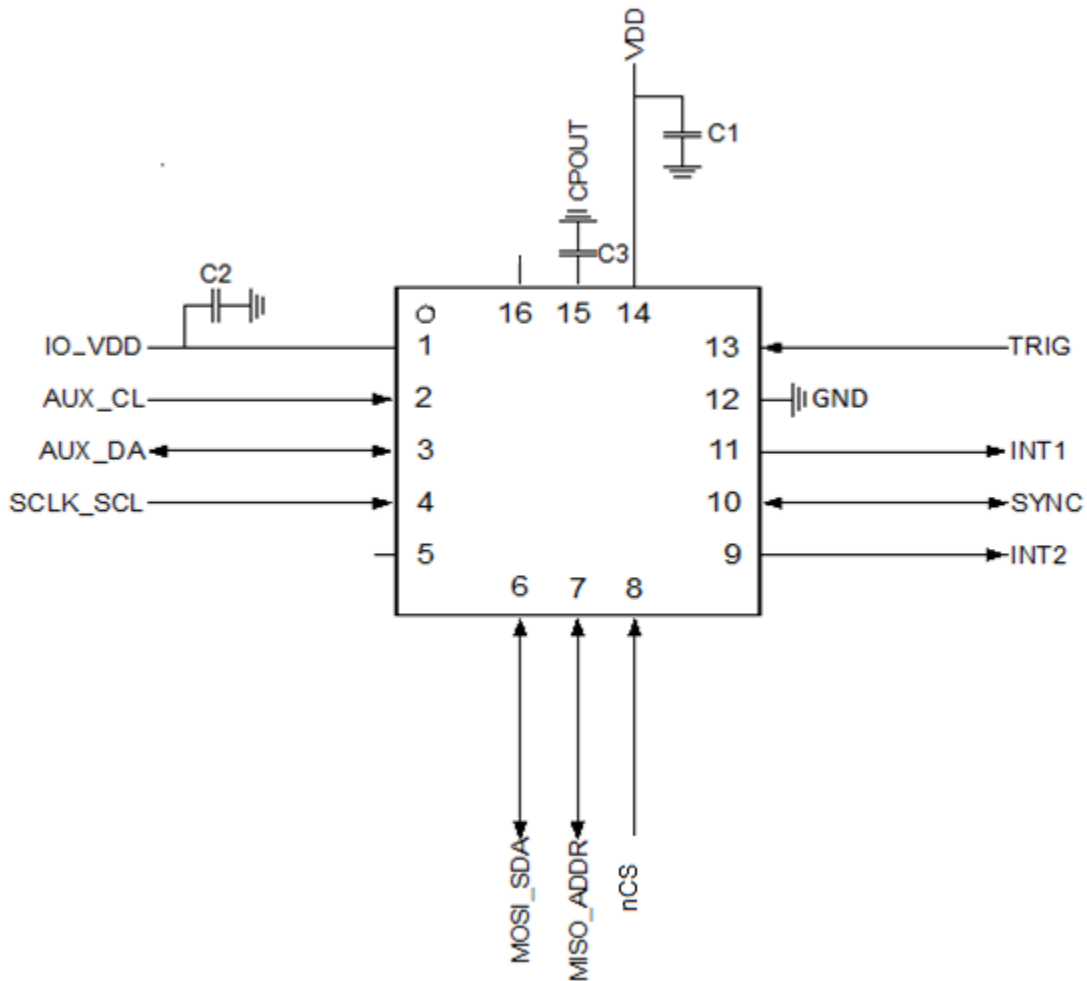

ID	Stress	Value	Rating	Type
C1	3 V	0.1 μ F	16 V	Y5V
C2	3 V	0.1 μ F	16 V	Y5V
C3	20 V	2.2 nF	50 V	Y5V



Digital Tri-axis Gyroscope/ Tri-axis Accelerometer Specifications

PART NUMBER

KXG03-1034

Rev. 2.0

14-Feb-17

Pin Descriptions

Pin	Name	Description
1	IO_VDD	External supply for IO ring. Connect bypass capacitor C2
2	AUX_CL ⁴	Auxiliary I ² C master serial clock
3	AUX_DA ⁴	Auxiliary I ² C master serial data
4	SCLK_SCL ¹	SPI/I ² C serial clock
5	RESERVED	Connect to GND or leave floating. Do not connect to IO_VDD.
6	MOSI_SDA ²	SPI MOSI / I ² C serial data
7	MISO_ADDR	Serial data input during 4-wire SPI communication and part of the device address during I ² C communication.
8	nCS	Chip Select (active LOW) for SPI communication. Connect to IO_VDD for I ² C communication. Do not leave floating.
9	INT2	Programmable interrupt output. Leave floating if not used.
10	SYNC ³	Sync input or output. If configured as input, connect to IO_VDD or GND. If configured as output, leave floating.
11	INT1	Programmable interrupt output. Leave floating if not used.
12	GND	Ground
13	TRIG	External trigger input for buffer actions. Connect to IO_VDD or GND if unused.
14	VDD	External supply with bypass capacitor C1
15	CPOUT	External charge pump reservoir cap C3
16	RESERVED	Connect to GND or leave floating

Table 6: Pin Descriptions

Notes:

- 1, 2 For I²C communication, connect an external IO_VDD pull-up resistors on SCL (pin 4) and SDA (pin 6). The value of the pull up resistors should be 1.5 k Ω or above to ensure a V_{OL} that is less than the maximum specified value.
- 3 Care must be taken with external connection of the SYNC pin. The reset state of the SYNC pin is tri-stated. If pin is not used in application, connect to IO_VDD or GND and ensure the state of the pin is never changed to output through register write to FSYNC_CTL register. If pin is configured as Output in the application, the pin must be left floating to avoid internal short circuit to IO_VDD or GND.
- 4 The AUX_DA and AUX_CL pins should be left floating for applications that do not use the auxiliary I²C interface. Applications interfacing to the sensor in I²C mode and not using aux I²C can keep the default aux_bypass=1 and aux_pull_up=0 settings (see AUX_I2C_CTL_REG). Applications trying to limit the main I²C bus capacitance should set aux_bypass=0 and aux_pull_up=1. Applications interfacing to the sensor in SPI mode and not using aux I²C should set bypass=0 and pull_up=1. Please note SPI applications may see increased standby current until aux_bypass and aux_pull_up have been changed from the default settings.



Digital Tri-axis Gyroscope/ Tri-axis Accelerometer Specifications

PART NUMBER
KXG03-1034
 Rev. 2.0
 14-Feb-17

Package Dimensions and Orientation:

Dimensions

3 x 3 x 0.9 mm LGA Dimensions

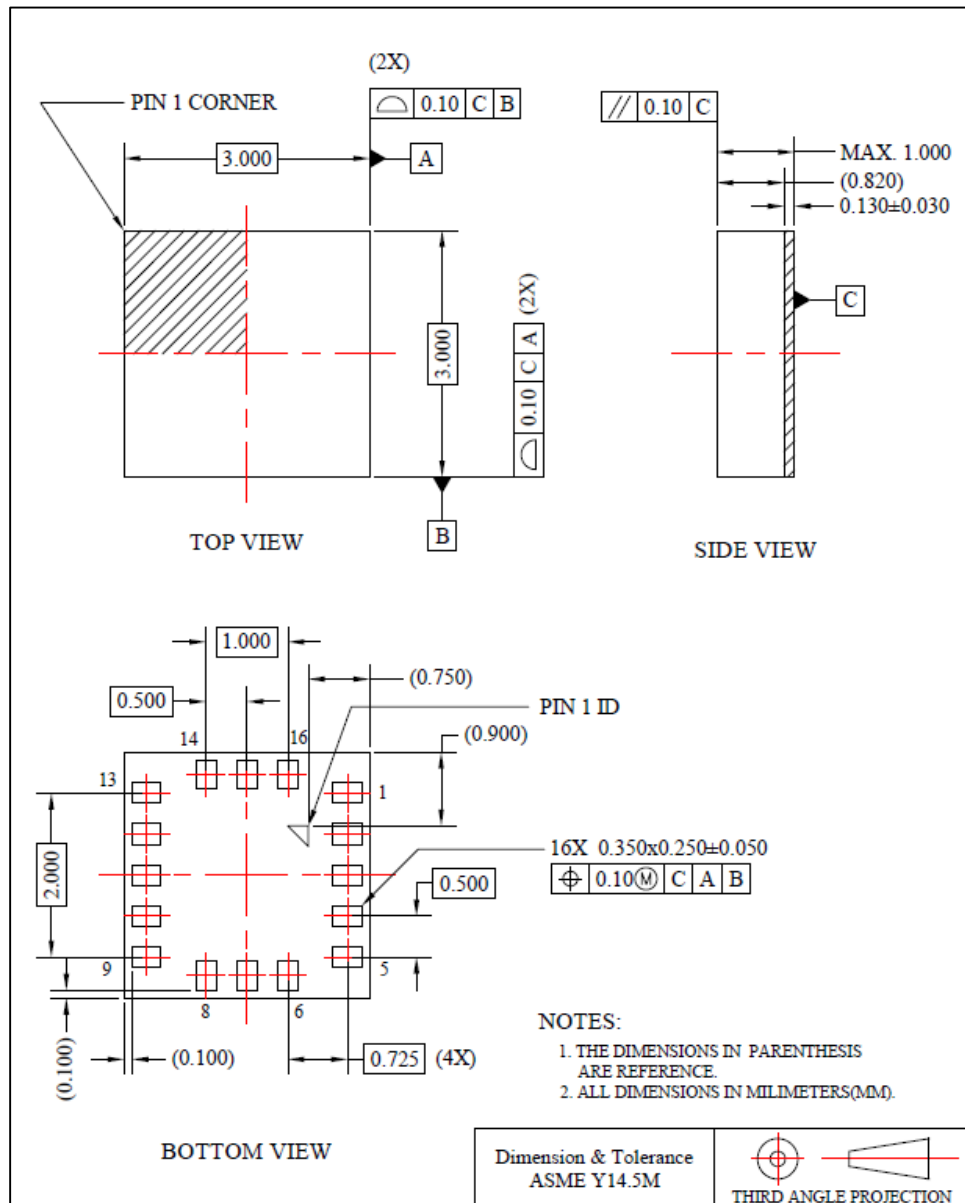

Figure 1: Package Dimensions



Digital Tri-axis Gyroscope/ Tri-axis Accelerometer Specifications

PART NUMBER
KXG03-1034
Rev. 2.0
14-Feb-17

Orientation

When the device is accelerated or rotated in +X, +Y, or +Z direction, the corresponding output will increase.

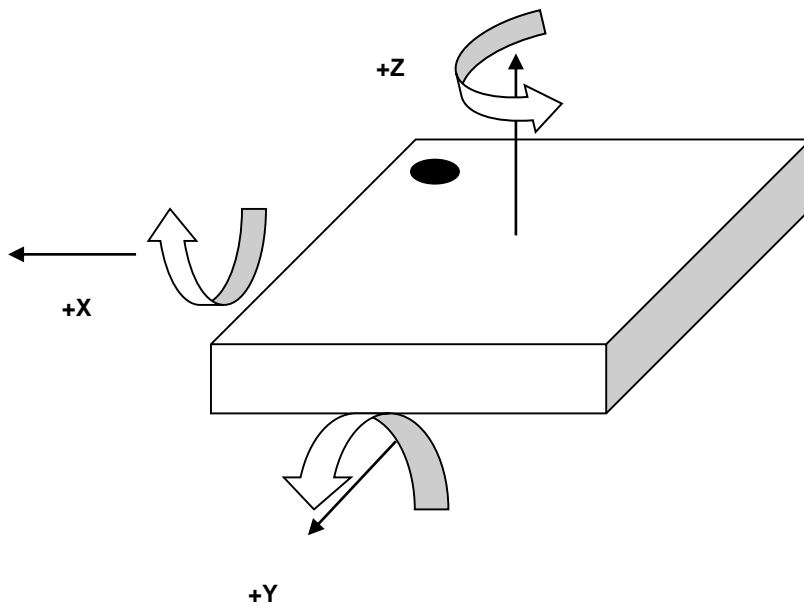



Figure 2: Device Orientation

	Digital Tri-axis Gyroscope/ Tri-axis Accelerometer Specifications	PART NUMBER KXG03-1034 Rev. 2.0 14-Feb-17
---	--	--

Digital Interface

The Kionix KXG03 digital sensor has the ability to communicate via the I²C and SPI digital serial interface protocols. This allows for easy system integration by eliminating analog-to-digital converter requirements and by providing direct communication with system micro-controllers.

The serial interface terms and descriptions as indicated in the table below will be observed throughout this document.

Term	Description
Transmitter	The device that transmits data to the bus.
Receiver	The device that receives data from the bus.
Master	The device that initiates a transfer, generates clock signals, and terminates a transfer.
Slave	The device addressed by the Master.

Table 7: Serial Interface Terminologies

I²C Serial Interface

As previously mentioned, the KXG03 has the ability to communicate on an I²C bus. I²C is primarily used for synchronous serial communication between a Master device and one or more Slave devices. The Master, typically a micro controller, provides the serial clock signal and addresses Slave devices on the bus. The KXG03 always operates as a Slave device during standard Master-Slave I²C operation.

I²C is a two-wire serial interface that contains a Serial Clock (SCL) line and a Serial Data (SDA) line. SCL is a serial clock that is provided by the Master, but can be held low by any Slave device, putting the Master into a wait condition. SDA is a bi-directional line used to transmit and receive data to and from the interface. Data is transmitted MSB (Most Significant Bit) first in 8-bit per byte format, and the number of bytes transmitted per transfer is unlimited. The I²C bus is considered free when both lines are high.

The I²C interface is compliant with high-speed mode, fast mode and standard mode I²C protocols.



Digital Tri-axis Gyroscope/ Tri-axis Accelerometer Specifications

PART NUMBER

KXG03-1034

Rev. 2.0

14-Feb-17

I²C Operation

Transactions on the I²C bus begin after the Master transmits a start condition (S), which is defined as a high-to-low transition on the data line while the SCL line is held high. The bus is considered busy after this condition. The next byte of data transmitted after the start condition contains the Slave Address (SAD) in the seven MSBs (Most Significant Bits), and the LSB (Least Significant Bit) tells whether the Master will be receiving data '1' from the Slave or transmitting data '0' to the Slave. When a Slave Address is sent, each device on the bus compares the seven MSBs with its internally stored address. If they match, the device considers itself addressed by the Master. The KXG03 Slave Address is comprised of a user programmable part, a factory programmable part, and a fixed part, which allows for connection of multiple sensors to the same I²C bus. The Slave Address associated with the KXG03 is 10011YX, where the user programmable bit X, is determined by the assignment of MISO_ADDR (pin 7) to GND or IO_VDD. Also, the factory programmable bit Y is set at the factory. For KXG03-1034, the factory programmable bit Y is fixed to 1 (contact your Kionix sales representative for list of available devices). Table 8 lists possible I²C addresses for KXG03-1034.

Description	Address Pad	7-bit Address	Address	<7>	<6>	<5>	<4>	<3>	Y		X	
									<2>	<1>	<1>	<0>
I2C Wr	GND	0x4E	0x9C	1	0	0	1	1	1	0	0	0
I2C Rd	GND	0x4E	0x9D	1	0	0	1	1	1	0	1	1
I2C Wr	IO_VDD	0x4F	0x9E	1	0	0	1	1	1	1	0	0
I2C Rd	IO_VDD	0x4F	0x9F	1	0	0	1	1	1	1	1	1

Table 8: I²C Slave Addresses for KXG03-1034

It is mandatory that receiving devices acknowledge (ACK) each transaction. Therefore, the transmitter must release the SDA line during this ACK pulse. The receiver then pulls the data line low so that it remains stable low during the high period of the ACK clock pulse. A receiver that has been addressed, whether it is Master or Slave, is obliged to generate an ACK after each byte of data has been received. To conclude a transaction, the Master must transmit a stop condition (P) by transitioning the SDA line from low to high while SCL is high. The I²C bus is now free. Note that if the KXG03 is accessed through I²C protocol before the startup is finished a NACK signal is sent.



Digital Tri-axis Gyroscope/ Tri-axis Accelerometer Specifications

PART NUMBER
KXG03-1034
Rev. 2.0
14-Feb-17

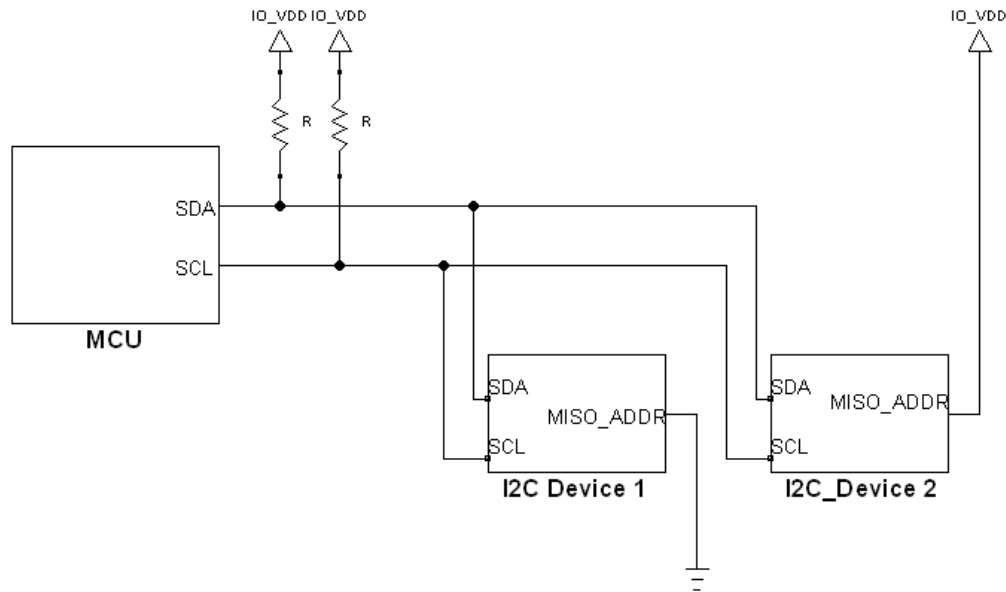

I2C Device	Part Number	ADDR Pin	Slave Address	Bit Y (Bit 1 in 7-bit address)
1	KXG03-1034	GND	0x4E	Factory Set to 1
2	KXG03-1034	IO_VDD	0x4F	Factory Set to 1

Figure 3: Multiple KXG03 Sensors on a Shared I²C Bus

Writing to 8-bit Register

Upon power up, the Master must write to the KXG03's control registers to set its operational mode. Therefore, when writing to a control register on the I²C bus, as shown Sequence 1 on the following page, the following protocol must be observed: After a start condition, SAD+W transmission, and the KXG03 ACK has been returned, an 8-bit Register Address (RA) command is transmitted by the Master. This command is telling the KXG03 to which 8-bit register the Master will be writing the data. Since this is I²C mode, the MSB of the RA command should always be zero (0). The KXG03 acknowledges the RA and the Master transmits the data to be stored in the 8-bit register. The KXG03 acknowledges that it has received the data and the Master transmits a stop condition (P) to end the data transfer. The data sent to the KXG03 is now stored in the appropriate register. The KXG03 automatically increments the received RA commands and, therefore, multiple bytes of data can be written to sequential registers after each Slave ACK as shown in Sequence 2 on the following page.

Note** If a STOP condition is sent on the least significant bit of write data or the following master acknowledge cycle, the last write operation is not guaranteed and it may alter the content of the affected registers.

	Digital Tri-axis Gyroscope/ Tri-axis Accelerometer Specifications	PART NUMBER KXG03-1034 Rev. 2.0 14-Feb-17
---	--	--

Reading from 8-bit Register

When reading data from a KXG03 8-bit register on the I²C bus, as shown in Sequence 3 on the next page, the following protocol must be observed: The Master first transmits a start condition (S) and the appropriate Slave Address (SAD) with the LSB set at '0' to write. The KXG03 acknowledges and the Master transmits the 8-bit RA of the register it wants to read. The KXG03 again acknowledges, and the Master transmits a repeated start condition (Sr). After the repeated start condition, the Master addresses the KXG03 with a '1' in the LSB (SAD+R) to read from the previously selected register. The Slave then acknowledges and transmits the data from the requested register. The Master does not acknowledge (NACK) it received the transmitted data, but transmits a stop condition to end the data transfer. Note that the KXG03 automatically increments through its sequential registers, allowing data to be read from multiple registers following a single SAD+R command as shown below in Sequence 4 below. Reading data from a buffer read register is a special case because if register address (RA) is set to buffer read register (BUF_READ) in Sequence 4, the register auto-increment feature is automatically disabled. Instead, the Read Pointer will increment to the next data in the buffer, thus allowing reading multiple bytes of data from the buffer using a single SAD+R command. Note, accelerometer's and/or gyroscope's output data should be read in a single transaction using the auto-increment feature to prevent output data from being updated prior to intended completion of the read transaction.

****Note**** KXG03's output data should be read in a single transaction using the auto-increment feature to prevent output data from being updated prior to intended completion of the read transaction.



Digital Tri-axis Gyroscope/ Tri-axis Accelerometer Specifications

PART NUMBER

KXG03-1034

Rev. 2.0

14-Feb-17

Data Transfer Sequences

The following information clearly illustrates the variety of data transfers that can occur on the I²C bus and how the Master and Slave interact during these transfers. The table below defines the I²C terms used during the data transfers.

Term	Definition
S	Start Condition
Sr	Repeated Start Condition
SAD	Slave Address
W	Write Bit
R	Read Bit
ACK	Acknowledge
NACK	Not Acknowledge
RA	Register Address
Data	Transmitted/Received Data
P	Stop Condition

Table 9: I²C Terms

Sequence 1. The Master is writing one byte to the Slave.

Master	S	SAD + W		RA		DATA		P
Slave			ACK		ACK		ACK	

Sequence 2. The Master is writing multiple bytes to the Slave.

Master	S	SAD + W		RA		DATA		DATA		P
Slave			ACK		ACK		ACK		ACK	

Sequence 3. The Master is receiving one byte of data from the Slave.

Master	S	SAD + W		RA		Sr	SAD + R			NACK	P
Slave			ACK		ACK			ACK	DATA		

Sequence 4. The Master is receiving multiple bytes of data from the Slave.

Master	S	SAD + W		RA		Sr	SAD + R			ACK		NACK	P
Slave			ACK		ACK			ACK	DATA		DATA		

	Digital Tri-axis Gyroscope/ Tri-axis Accelerometer Specifications		PART NUMBER	
			KXG03-1034	
			Rev. 2.0	
			14-Feb-17	

HS-mode

To enter the 3.4MHz high speed mode of communication, the device must receive the following sequence of conditions from the master: a Start condition followed by a Master code (00001XXX) and a Master Non-acknowledge. Once recognized, the device switches to HS-mode communication. Read/write data transfers then proceed as described in the sequences above. Devices return to the FS-mode after a STOP occurrence on the bus.

Sequence 5: HS-mode data transfer of the Master writing multiple bytes to the Slave.

Speed	FS-mode			HS-mode								FS-mode
Master	S	M-code	NACK	Sr	SAD + W		RA		DATA		P	
Slave						ACK		ACK		ACK		

n bytes + ack.

Sequence 6: HS-mode data transfer of the Master receiving multiple bytes of data from the Slave.

Speed	FS-mode			HS-mode				
Master	S	M-code	NACK	Sr	SAD + W		RA	
Slave						ACK		ACK

Speed	HS-mode								FS-mode
Master	Sr	SAD + R					NACK	P	
Slave			ACK	DATA	ACK	DATA			

(n-1) bytes + ack.



Digital Tri-axis Gyroscope/ Tri-axis Accelerometer Specifications

PART NUMBER

KXG03-1034

Rev. 2.0

14-Feb-17

I²C Timing Diagram

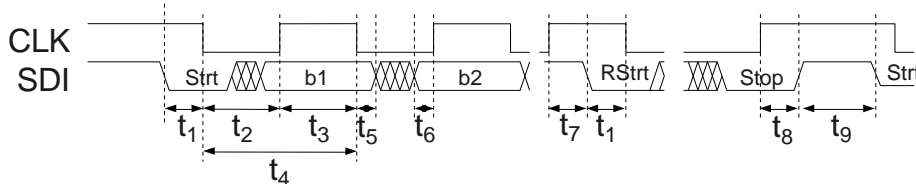

I²C Timing Specifications

Number	Description	Standard and Fast Mode		High Speed Mode		Units
		MIN	MAX	MIN	MAX	
t ₁	Hold time START condition	600		160		ns
t ₂	SCL low	1300		320		ns
t ₃	SCL high	600		120		ns
t ₄	SCL Period	25000		588		ns
t ₅	SDI to SCL rise setup time	100		10		ns
t ₆	SCL fall to SDI hold time	0	900	0	150	ns
t ₇	Setup time for repeated START condition	600		160		ns
t ₈	Setup time SCL rise to SDI rise for STOP condition	600		600		ns
t ₉	Bus free time between STOP and START conditions	1300		1300		ns
	SCL rise transition time (30-70%)		300		160	ns
	SCL fall transition time (30-70%)		300		80	ns
	SDI rise transition time (30-70%)		300		80	ns
	SDI fall transition time (30-70%)		300		160	ns

Table 10: I²C Timing Specifications (Standard, Fast and High Speed Mode)

	Digital Tri-axis Gyroscope/ Tri-axis Accelerometer Specifications	PART NUMBER KXG03-1034 Rev. 2.0 14-Feb-17
---	--	--

Auxiliary I²C Operation

The KXG03 has an auxiliary I²C bus for communicating to external I²C-supported sensors. This bus has an I²C Host Mode where the KXG03 acts as a host to external sensors, and a Bypass Mode where the KXG03 directly connects the primary and auxiliary I²C buses together. This allows the system processor to directly communicate with the external sensors. Maximum data rate for this bus is 400KHz Fast Mode. With the auxiliary I²C enabled the AUX_CL pin operates as an output-only pin. The auxiliary I²C hence does not support clock stretching and KXG03 should not be mated with external devices using clock stretching

Auxiliary I²C Host Mode

This mode allows the KXG03 to directly access the data registers of any external sensors connected to the auxiliary I²C bus. In this mode, the KXG03 directly obtains data from the auxiliary sensors and packages them with its own sensor data inside the internal FIFO buffer.

In Host Mode the KXG03 is easily configured to read up to six successive registers from up to two different auxiliary devices. The user simply configures KXG03 control registers with up to two different I²C SAD's, starting register addresses and the number of bytes to be read back via auto-increment.

Auxiliary I²C Bypass Mode

This mode allows an external processor to act as host and directly communicate to the auxiliary devices. This allows the host to initialize the auxiliary sensors for operation, or to access them directly while the KXG03 is disabled. The AUX_CL and AUX_DA pins can be operated in bypass mode shorted to SCLK_SCL and the MOSI_SDA pins, respectively. When operated in bypass mode the connection to the main I²C pins is broken while nCS is low (i.e. while the main interface is operating in SPI mode).

Internal Pull-up Resistor

The auxiliary I²C interface can be operated with external or internal pull up devices. Internal pull up devices are automatically disabled in bypass mode to prevent pulling up the main I²C /SPI interface. The KXG03 AUX_CL pin is driven by as a rail-to-rail (push-pull) CMOS output. The AUX_CL pin hence does not require external (or internal) pull ups.

	Digital Tri-axis Gyroscope/ Tri-axis Accelerometer Specifications	PART NUMBER
		KXG03-1034
		Rev. 2.0
		14-Feb-17

SPI Communications

Special Note: The KXG03 has an I2C-disable bit I2C_DIS in CTL_REG_1 that defaults to 0 (I2C enabled) on power up or when exiting reset. The state of this bit can only be changed via SPI communications. For applications using SPI on a shared bus (multiple slave devices on a single nCS line) I2C_DIS should be set 1. Applications using a SPI interface on a dedicated bus (nCS connects only to KXG03 and not to any other slave devices) can function with I2C_DIS set to 0 or 1. For applications using I2C interface I2C_DIS should be set 0.

4-Wire SPI Interface

The KXG03 also utilizes an integrated 4-Wire Serial Peripheral Interface (SPI) for digital communication. The SPI interface is primarily used for synchronous serial communication between one Master device and one or more Slave devices. The Master, typically a micro controller, provides the SPI clock signal (SCLK) and determines the state of Chip Select (nCS). The KXG03 always operates as a Slave device during standard Master-Slave SPI operation.

4-wire SPI is a synchronous serial interface that uses two control and two data lines. With respect to the Master, the Serial Clock output (SCLK), the Data Output (SDI or MOSI) and the Data Input (SDO or MISO) are shared among the Slave devices. The Master generates an independent Chip Select (nCS) for each Slave device that goes low at the start of transmission and goes back high at the end. The Slave Data Output (SDO) line, remains in a high-impedance (hi-z) state when the device is not selected, so it does not interfere with any active devices. This allows multiple Slave devices to share a master SPI port as shown in the figure below.

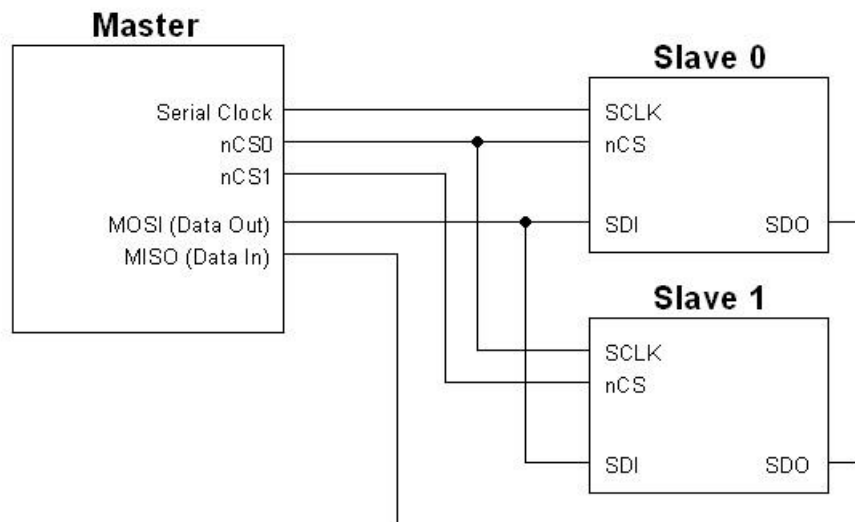

Figure 4: 4-wire SPI Connections



Digital Tri-axis Gyroscope/ Tri-axis Accelerometer Specifications

PART NUMBER
KXG03-1034
 Rev. 2.0
 14-Feb-17

4-Wire SPI Timing Diagram

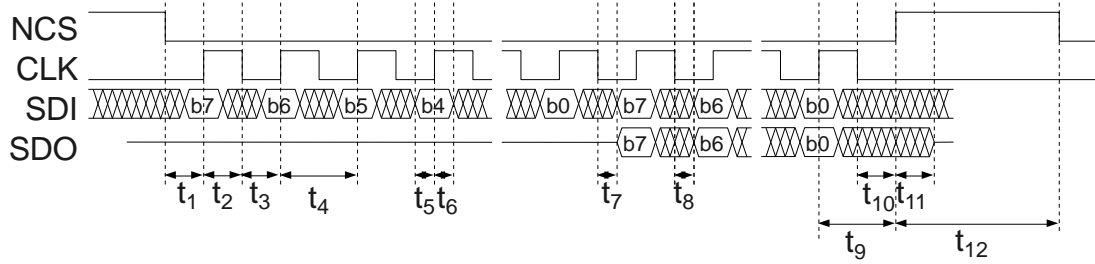

Number	Description	MIN	MAX	Units
t1	NCS fall to SCL rise	40		ns
t2	SCL pulse width high	40		ns
t3	SCL pulse width low	40		ns
t4	SCL period	98		ns
t5	SDI to SCL rise setup time	10		ns
t6	SCL rise to SDI hold time	10		ns
t7	SCL rise to SDO enabled from tri-state	0		ns
t8	SCL rise to SDO (min. = data invalid, max. = data valid)	0	35	ns
t9	SCL fall to NCS rise (Must be met only if SDI is not stable during this time)	40		ns
t10	NCS rise to SDO tri-state		40	ns
t11	NCS high	100		ns
t12	NCS rise to SCL rise	40		ns

Table 11: 4-Wire SPI Timing



Digital Tri-axis Gyroscope/ Tri-axis Accelerometer Specifications

PART NUMBER
KXG03-1034
Rev. 2.0
14-Feb-17

4-Wire Read and Write Registers

The registers embedded in the KXG03 have 8-bit addresses. Upon power up, the Master must write to the sensor's control registers to set its operational mode. On the falling edge of nCS, a 2-byte command is written to the appropriate control register. The first byte initiates the write to the appropriate register, and is followed by the user-defined, data byte. The MSB (Most Significant Bit) of the register address byte will indicate "0" when writing to the register and "1" when reading from the register. This operation occurs over 16 clock cycles. All commands are sent MSB first. The host must return nCS high for at least one clock cycle before the next data request. However, when data is being read from a buffer read register (BUF_READ), the nCS signal can remain low until the buffer is read. The Figure 5 shows the timing diagram for carrying out an 8-bit register write operation.

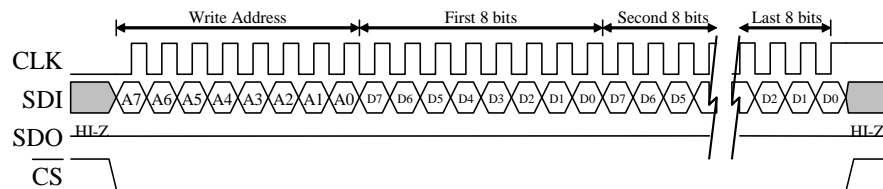

Figure 5: Timing Diagram for 8-Bit Register Write Operation

In order to read an 8-bit register, an 8-bit register address must be written to the sensor to initiate the read. The MSB of this register address byte will indicate "0" when writing to the register and "1" when reading from the register. Upon receiving the address, the sensor returns the 8-bit data stored in the addressed register. This operation also occurs over 16 clock cycles. All returned data is sent MSB first, and the host must return nCS high for at least one clock cycle before the next data request. The Figure 6 shows the timing diagram for an 8-bit register read operation.

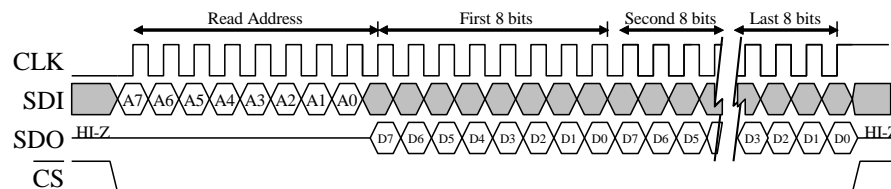



Figure 6: Timing Diagram for 8-Bit Register Read Operation

	Digital Tri-axis Gyroscope/ Tri-axis Accelerometer Specifications	PART NUMBER
		KXG03-1034
		Rev. 2.0
		14-Feb-17

Power Modes

The KXG03 has three power modes: Off, Stand-by, and Active. The part exists in one of these three modes at any given time. Off and Stand-by modes have very low current consumptions.

Power Mode	Bus State	IO_VDD	VDD	Function	Outputs
Off	-	OFF	OFF	No sensor activity	Not available
Off	-	ON	OFF	No sensor activity	Not available
Off	-	OFF	ON	No sensor activity	Not available
Stand-by	Active	ON	ON	Waiting activation command	Not available
Active - WUF	Active	ON	ON	Accelerometer active looking for motion Wake-up	Accelerometer registers, buffer, and DRDY
Active	Active	ON	ON	All functionalities available	All sensors available

Off mode

One or both of the power supplies (VDD or IO_VDD) are not powered. The sensor is completely inactive and not reporting or communicating. Bus communication actions of other devices are not disturbed if they are using the same bus interface as this component.

Initial Startup

The preferred startup sequence is to turn on IO_VDD before VDD, but if VDD is turned on first, the component will not affect the bus communications (no latch-up or other problems during engine system level wake-up).

Power-On Reset (POR) is performed every time when:

1. IO_VDD supply is valid
2. VDD power supply is going to valid level

OR

1. IO_VDD power supply is going to valid level
2. VDD supply is valid

When POR occurs, the registers are loaded from OTP and the part is put into Stand-by mode.

	Digital Tri-axis Gyroscope/ Tri-axis Accelerometer Specifications	PART NUMBER KXG03-1034 Rev. 2.0 14-Feb-17
---	--	--

Stand-by mode

The primary function of the stand-by mode is to ensure fast wake-up to active mode and to minimize current consumption. This mode is set as default when both power supplies are applied and the POR function occurs. A Soft Reset command also performs the POR function and puts the part into Stand-by mode.

Stand-by mode is a low power waiting state for fast turn on time. Bus communication actions of other components are not disturbed if they are using the same bus. There is only one possible way to change to active mode – a register command from the external application processor via the I²C bus.

Active WUF mode

While in Active WUF mode, the accelerometer is periodically taking a measurement to detect if there is any motion. Data in the accelerometer registers is being updated and can be sent to the buffer, and data ready interrupt can be reported.

Active Wake and Sleep mode

Stand-by-mode can be changed to Active mode by writing to register STBY_REG or by use of the WUF.

Active mode engages the full functionality of accelerometer and/or gyroscope measurements in two possible configurations, one is named Wake the other Sleep. The user can select separate configurations for each mode such as ODR, BW, FS-range and even Standby bits for each mode. For example, the user could enable all sensors in Wake state and only the Aux sensor in Sleep state. Or the user could enable the accelerometer in low power mode during Wake state and both the gyroscope and accelerometer in sleep state

The WUF and BTS functions can be used to automatically switch between the two modes based on measured accelerometer activity. The user can select which functions and sensors are enabled for each mode.

	<p align="center">Digital Tri-axis Gyroscope/ Tri-axis Accelerometer Specifications</p>	<p align="center">PART NUMBER KXG03-1034 Rev. 2.0 14-Feb-17</p>
---	--	--

Embedded Wake-up and Back-to-Sleep Function

The KXG03 contains an interrupt engine that can be configured by the user to report when qualified changes detected by the acceleration occur, using the accelerometer. The user has the option to enable or disable specific accelerometer axes and specific directions, as well as to specify the delay time. An example use case for the engine would be to detect motion on any axis to signal an event and wake up or put back to sleep the KXG03 or other devices. For Wake-up (WUF), this can be achieved by configuring the engine to detect when the acceleration on any axis is *greater* than the user-defined threshold for a user-defined amount of time. For Back-To-Sleep (BTS), this can be achieved by configuring the engine to detect when the acceleration on any axis is *less* than the user-defined threshold for a user-defined amount of time. The KXG03 will change modes when the WUF or BTS functions trigger. The user can manually force the KXG03 into Wake or Sleep modes using the MAN_WAKE and MAN_SLEEP bits. The equations below show how to calculate the engine threshold and delay time register values for the desired result.

$$\text{Wake-up Threshold (counts)} = \text{Desired Threshold (g)} \times 16 \text{ (counts/g)}$$

Equation 1: Wake-up Threshold

$$\text{Back-To-Sleep Threshold (counts)} = \text{Desired Threshold (g)} \times 16 \text{ (counts/g)}$$

Equation 2: Back-To-Sleep Threshold

$$\text{Back-To-Sleep Threshold (counts)} = \text{Desired Delay Time (sec)} \times \text{OWUF (Hz)}$$

Equation 3: Wake-up Delay Time

$$\text{Back-To-Sleep Delay Time (counts)} = \text{Desired Delay Time (sec)} \times \text{OSA (Hz)}$$

Equation 4: Back-To-Sleep Delay Time



Digital Tri-axis Gyroscope/ Tri-axis Accelerometer Specifications

PART NUMBER

KXG03-1034

Rev. 2.0

14-Feb-17

Embedded Registers

The KXG03 has embedded 8-bit registers that are accessible by the user. This section contains the addresses for all embedded registers and also describes bit functions of each register. The table below provides a listing of the accessible 8-bit registers and their addresses.

Register Name	R/W	Address	Register Name	R/W	Address	Register Name	R/W	Address
TEMP_OUT_L	R	0x00	BUF_PAST_L	R	0x20	WAKE_SLEEP_CTL2	R/W	0x4C
TEMP_OUT_H	R	0x01	BUF_PAST_H	R	0x21	WUF_TH	R/W	0x4D
GYRO_XOUT_L	R	0x02	AUX_STATUS	R	0x22	WUF_COUNTER	R/W	0x4E
GYRO_XOUT_H	R	0x03	RESERVED	R	0x23-0x2F	BTS_TH	R/W	0x4F
GYRO_YOUT_L	R	0x04	WHO_AM_I	R	0x30	BTS_COUNTER	R/W	0x50
GYRO_YOUT_H	R	0x05	SN1_MIR	R	0x31	AUX_I2C_CTL_REG	R/W	0x51
GYRO_ZOUT_L	R	0x06	SN2_MIR	R	0x32	AUX_I2C_SAD1	R/W	0x52
GYRO_ZOUT_H	R	0x07	SN3_MIR	R	0x33	AUX_I2C_REG1	R/W	0x53
ACC_XOUT_L	R	0x08	SN4_MIR	R	0x34	AUX_I2C_CTL1	R/W	0x54
ACC_XOUT_H	R	0x09	RESERVED	R	0x35	AUX_I2C_BIT1	R/W	0x55
ACC_YOUT_L	R	0x0A	STATUS1	R/W	0x36	AUX_I2C_ODR1_W	R/W	0x56
ACC_YOUT_H	R	0x0B	INT1_SRC1	R	0x37	AUX_I2C_ODR1_S	R/W	0x57
ACC_ZOUT_L	R	0x0C	INT1_SRC2	R	0x38	AUX_I2C_SAD2	R/W	0x58
ACC_ZOUT_H	R	0x0D	INT1_L	R	0x39	AUX_I2C_REG2	R/W	0x59
AUX1_OUT1	R	0x0E	STATUS2	R/W	0x3A	AUX_I2C_CTL2	R/W	0x5A
AUX1_OUT2	R	0x0F	INT2_SRC1	R	0x3B	AUX_I2C_BIT2	R/W	0x5B
AUX1_OUT3	R	0x10	INT2_SRC2	R	0x3C	AUX_I2C_ODR2_W	R/W	0x5C
AUX1_OUT4	R	0x11	INT2_L	R	0x3D	AUX_I2C_ODR2_S	R/W	0x5D
AUX1_OUT5	R	0x12	ACCEL_ODR_WAKE	R/W	0x3E	RESERVED	R/W	0x5E-0x74
AUX1_OUT6	R	0x13	ACCEL_ODR_SLEEP	R/W	0x3F	BUF_WMITH_L	R/W	0x75
AUX2_OUT1	R	0x14	ACCEL_CTL	R/W	0x40	BUF_WMITH_H	R/W	0x76
AUX2_OUT2	R	0x15	GYRO_ODR_WAKE	R/W	0x41	BUF_TRIGTH_L	R/W	0x77
AUX2_OUT3	R	0x16	GYRO_ODR_SLEEP	R/W	0x42	BUF_TRIGTH_H	R/W	0x78
AUX2_OUT4	R	0x17	STDBY	R/W	0x43	BUF_CTL2	R/W	0x79
AUX2_OUT5	R	0x18	CTL_REG_1	R/W	0x44	BUF_CTL3	R/W	0x7A
AUX2_OUT6	R	0x19	INT_PIN_CTL	R/W	0x45	BUF_CTL4	R/W	0x7B
WAKE_CNT_L	R	0x1A	INT_PIN1_SEL	R/W	0x46	BUF_EN	R/W	0x7C
WAKE_CNT_H	R	0x1B	INT_PIN2_SEL	R/W	0x47	BUF_STATUS	R	0x7D
SLEEP_CNT_L	R	0x1C	INT_MASK1	R/W	0x48	BUF_CLEAR	R/W	0x7E
SLEEP_CNT_H	R	0x1D	INT_MASK2	R/W	0x49	BUF_READ	R	0x7F
BUF_SMPLEV_L	R	0x1E	FSYNC_CTL	R/W	0x4A			
BUF_SMPLEV_H	R	0x1F	WAKE_SLEEP_CTL1	R/W	0x4B			

Table 12: I2C Register Map



Digital Tri-axis Gyroscope/ Tri-axis Accelerometer Specifications

PART NUMBER

KXG03-1034

Rev. 2.0

14-Feb-17

Gyroscope Outputs

These registers contain 16-bits of valid angular rate data for each axis. The data is protected from overwrite during each read, and can be converted from digital counts to angular rate (deg/sec) per the table below.

16-bit Data (2's complement)	Equivalent Counts in decimal	Range = ± 2048 deg/sec	Range = ± 1024 deg/sec	Range = ± 512 deg/sec	Range = ± 256 deg/sec
0111 1111 1111 1111	32767	+2047.9375	+1023.9688	+511.9844	+255.9922
0111 1111 1111 1110	32766	+2047.8750	+1023.9376	+511.9688	+255.9844
...
0000 0000 0000 0001	1	+0.0625	+0.0312	+0.0156	+0.0078
0000 0000 0000 0000	0	0 deg/sec	0 deg/sec	0 deg/sec	0 deg/sec
1111 1111 1111 1111	-1	-0.0625	-0.0312	-0.0156	-0.0078
...
1000 0000 0000 0001	-32767	-2047.9375	-1023.9688	-511.9844	-255.9922
1000 0000 0000 0000	-32768	-2048.0000	-1024.0000	-512.0000	-256.0000

Table 13: Angular Rate (deg/sec) Calculation

Accelerometer Outputs

These registers contain 16-bits of valid angular rate data for each axis. The data is protected from overwrite during each read, and can be converted from digital counts to acceleration (g) per the table below.

16-bit Data (2's complement)	Equivalent Counts in decimal	Range = $\pm 2g$	Range = $\pm 4g$	Range = $\pm 8g$	Range = $\pm 16g$
0111 1111 1111 1111	32767	+2.0000g	+3.9999g	+7.9998g	+15.9996g
0111 1111 1111 1110	32766	+1.9999g	+3.9998g	+7.9995g	+15.9992g
...
0000 0000 0000 0001	1	+0.00006g	+0.0001g	+0.0002g	+0.0004g
0000 0000 0000 0000	0	0.000g	0.000g	0.000g	0.000g
1111 1111 1111 1111	-1	-0.00006g	-0.0001g	-0.0002g	-0.0004g
...
1000 0000 0000 0001	-32767	-1.9999g	-3.9999g	-7.9998g	-15.9996g
1000 0000 0000 0000	-32768	-2.0000g	-4.0000g	-8.000g	-15.000g

Table 14: Acceleration (g) Calculation



Digital Tri-axis Gyroscope/ Tri-axis Accelerometer Specifications

PART NUMBER
KXG03-1034
 Rev. 2.0
 14-Feb-17

Temperature Sensor Outputs

The temperature registers contain up to 16-bits of temperature data. Sensitivity can be considered as 128 counts/°C, or 7.8mC/LSB.

16-bit Register Data (2's complement)	Equivalent Counts in decimal	Temperature (°C)
0010 1010 1000 0000	10880	+85.000 °C
...
0000 0000 1000 0000	128	+1.0000 °C
...
0000 0000 0000 0001	1	+0.0078 °C
0000 0000 0000 0000	0	0.0000 °C
1111 1111 1111 1111	-1	-0.0078 °C
...
1111 1111 1000 0000	-128	-1.0000 °C
...
1110 1100 0000 0000	-5120	-40.000 °C

Table 15: Temperature (C) Calculation



Digital Tri-axis Gyroscope/ Tri-axis Accelerometer Specifications

PART NUMBER

KXG03-1034

Rev. 2.0

14-Feb-17

Register Descriptions

TEMP_OUT

Temperature Output least and most significant bytes TEMP_OUT_L and TEMP_OUT_H

R	R	R	R	R	R	R	R
TEMP7	TEMP6	TEMP5	TEMP4	TEMP3	TEMP2	TEMP1	TEMP0
TEMP15	TEMP14	TEMP13	TEMP12	TEMP11	TEMP10	TEMP9	TEMP8
Bit7	Bit6	Bit5	Bit4	Bit3	Bit2	Bit1	Bit0
Address: 0x00,0x01							

GYRO_XOUT

X-axis gyroscope output least and most significant bytes GYRO_XOUT_L and GYRO_XOUT_H

R	R	R	R	R	R	R	R
GYRO_X7	GYRO_X6	GYRO_X5	GYRO_X4	GYRO_X3	GYRO_X2	GYRO_X1	GYRO_X0
GYRO_X15	GYRO_X14	GYRO_X13	GYRO_X12	GYRO_X11	GYRO_X10	GYRO_X9	GYRO_X8
Bit7	Bit6	Bit5	Bit4	Bit3	Bit2	Bit1	Bit0
Address: 0x02,0x03							

GYRO_YOUT

Y-axis gyroscope output least and most significant bytes GYRO_YOUT_L and GYRO_YOUT_H

R	R	R	R	R	R	R	R
GYRO_Y7	GYRO_Y6	GYRO_Y5	GYRO_Y4	GYRO_Y3	GYRO_Y2	GYRO_Y1	GYRO_Y0
GYRO_Y15	GYRO_Y14	GYRO_Y13	GYRO_Y12	GYRO_Y11	GYRO_Y10	GYRO_Y9	GYRO_Y8
Bit7	Bit6	Bit5	Bit4	Bit3	Bit2	Bit1	Bit0
Address: 0x04,0x05							

GYRO_ZOUT

Z-axis gyroscope output least and most significant bytes GYRO_ZOUT_L and GYRO_ZOUT_H

R	R	R	R	R	R	R	R
GYRO_Z7	GYRO_Z6	GYRO_Z5	GYRO_Z4	GYRO_Z3	GYRO_Z2	GYRO_Z1	GYRO_Z0
GYRO_Z15	GYRO_Z14	GYRO_Z13	GYRO_Z12	GYRO_Z11	GYRO_Z10	GYRO_Z9	GYRO_Z8
Bit7	Bit6	Bit5	Bit4	Bit3	Bit2	Bit1	Bit0
Address: 0x06,0x07							



Digital Tri-axis Gyroscope/ Tri-axis Accelerometer Specifications

PART NUMBER

KXG03-1034

Rev. 2.0

14-Feb-17

ACCEL_XOUT

X-axis accelerometer output least and most significant byte ACCEL_XOUT_L and ACCEL_XOUT_H

R	R	R	R	R	R	R	R
ACCEL_X7	ACCEL_X6	ACCEL_X5	ACCEL_X4	ACCEL_X3	ACCEL_X2	ACCEL_X1	ACCEL_X0
ACCEL_X15	ACCEL_X14	ACCEL_X13	ACCEL_X12	ACCEL_X11	ACCEL_X10	ACCEL_X9	ACCEL_X8
Bit7	Bit6	Bit5	Bit4	Bit3	Bit2	Bit1	Bit0
Address: 0x08,0x09							

ACCEL_YOUT

Y-axis accelerometer output least and most significant byte ACCEL_YOUT_L and ACCEL_YOUT_H

R	R	R	R	R	R	R	R
ACCEL_Y7	ACCEL_Y6	ACCEL_Y5	ACCEL_Y4	ACCEL_Y3	ACCEL_Y2	ACCEL_Y1	ACCEL_Y0
ACCEL_Y15	ACCEL_Y14	ACCEL_Y13	ACCEL_Y12	ACCEL_Y11	ACCEL_Y10	ACCEL_Y9	ACCEL_Y8
Bit7	Bit6	Bit5	Bit4	Bit3	Bit2	Bit1	Bit0
Address: 0x0A,0x0B							

ACCEL_ZOUT

Z-axis accelerometer output least and most significant byte ACCEL_ZOUT_L and ACCEL_ZOUT_H

R	R	R	R	R	R	R	R
ACCEL_Z7	ACCEL_Z6	ACCEL_Z5	ACCEL_Z4	ACCEL_Z3	ACCEL_Z2	ACCEL_Z1	ACCEL_Z0
ACCEL_Z15	ACCEL_Z14	ACCEL_Z13	ACCEL_Z12	ACCEL_Z11	ACCEL_Z10	ACCEL_Z9	ACCEL_Z8
Bit7	Bit6	Bit5	Bit4	Bit3	Bit2	Bit1	Bit0
Address: 0x0C,0x0D							

AUX1_OUT

Auxiliary Sensor #1 output data bytes AUX1_OUT1 through AUX1_OUT6

R	R	R	R	R	R	R	R	Reset Value
AUX1_1_7	AUX1_1_6	AUX1_1_5	AUX1_1_4	AUX1_1_3	AUX1_1_2	AUX1_1_1	AUX1_1_0	0000
AUX1_2_7	AUX1_2_6	AUX1_2_5	AUX1_2_4	AUX1_2_3	AUX1_2_2	AUX1_2_1	AUX1_2_0	0000
AUX1_3_7	AUX1_3_6	AUX1_3_5	AUX1_3_4	AUX1_3_3	AUX1_3_2	AUX1_3_1	AUX1_3_0	0000
AUX1_4_7	AUX1_4_6	AUX1_4_5	AUX1_4_4	AUX1_4_3	AUX1_4_2	AUX1_4_1	AUX1_4_0	0000
AUX1_5_7	AUX1_5_6	AUX1_5_5	AUX1_5_4	AUX1_5_3	AUX1_5_2	AUX1_5_1	AUX1_5_0	0000
AUX1_6_7	AUX1_6_6	AUX1_6_5	AUX1_6_4	AUX1_6_3	AUX1_6_2	AUX1_6_1	AUX1_6_0	0000
Bit7	Bit6	Bit5	Bit4	Bit3	Bit2	Bit1	Bit0	
Address: 0x0E to 0x13								



Digital Tri-axis Gyroscope/ Tri-axis Accelerometer Specifications

PART NUMBER

KXG03-1034

Rev. 2.0

14-Feb-17

AUX2_OUT

Auxiliary Sensor #2 output data bytes AUX2_OUT1 through AUX2_OUT6

R	R	R	R	R	R	R	R	Reset Value
AUX2_1_7	AUX2_1_6	AUX2_1_5	AUX2_1_4	AUX2_1_3	AUX2_1_2	AUX2_1_1	AUX2_1_0	0000
AUX2_2_7	AUX2_2_6	AUX2_2_5	AUX2_2_4	AUX2_2_3	AUX2_2_2	AUX2_2_1	AUX2_2_0	0000
AUX2_3_7	AUX2_3_6	AUX2_3_5	AUX2_3_4	AUX2_3_3	AUX2_3_2	AUX2_3_1	AUX2_3_0	0000
AUX2_4_7	AUX2_4_6	AUX2_4_5	AUX2_4_4	AUX2_4_3	AUX2_4_2	AUX2_4_1	AUX2_4_0	0000
AUX2_5_7	AUX2_5_6	AUX2_5_5	AUX2_5_4	AUX2_5_3	AUX2_5_2	AUX2_5_1	AUX2_5_0	0000
AUX2_6_7	AUX2_6_6	AUX2_6_5	AUX2_6_4	AUX2_6_3	AUX2_6_2	AUX2_6_1	AUX2_6_0	0000
Bit7	Bit6	Bit5	Bit4	Bit3	Bit2	Bit1	Bit0	
Address: 0x14 to 0x19								

WAKE_CNT

Number of ODR cycles spent in wake state as measured in accelerometer ODRa_wake/ODRa_sleep periods. Data byte WAKE_CNT_L and WAKE_CNT_H.

R	R	R	R	R	R	R	R	Reset Value
WAKE_C7	WAKE_C6	WAKE_C5	WAKE_C4	WAKE_C3	WAKE_C2	WAKE_C1	WAKE_C0	0000
WAKE_C15	WAKE_C14	WAKE_C13	WAKE_C12	WAKE_C11	WAKE_C10	WAKE_C9	WAKE_C8	0000
Bit7	Bit6	Bit5	Bit4	Bit3	Bit2	Bit1	Bit0	
Address: 0x1A,0x1B								

SLEEP_CNT

Number of ODR cycles spent in sleep state as measured in accelerometer ODRa_wake/ODRa_sleep periods. Data byte SLEEP_CNT_L and SLEEP_CNT_H.

R	R	R	R	R	R	R	R	Reset Value
SLEEP_C7	SLEEP_C6	SLEEP_C5	SLEEP_C4	SLEEP_C3	SLEEP_C2	SLEEP_C1	SLEEP_C0	0000
SLEEP_C15	SLEEP_C14	SLEEP_C13	SLEEP_C12	SLEEP_C11	SLEEP_C10	SLEEP_C9	SLEEP_C8	0000
Bit7	Bit6	Bit5	Bit4	Bit3	Bit2	Bit1	Bit0	
Address: 0x1C,0x1D								

	Digital Tri-axis Gyroscope/ Tri-axis Accelerometer Specifications	PART NUMBER
		KXG03-1034
		Rev. 2.0
		14-Feb-17

BUF_SMPLEV

Reports the number of data packets (ODR cycles) currently stored in the buffer. Reading the buffer contents, BUF_SMPLEV or BUF_PAST within 10 us from enabling or clearing the buffer is not permitted to avoid corrupted data. Data bytes BUF_SMPLEV_L and BUF_SMPLEV_H

R	R	R	R	R	R	R	R	Reset Value
SMP_LEV1	SMP_LEV0	Reserved	Reserved	Reserved	Reserved	Reserved	Reserved	0000
SMP_LEV9	SMP_LEV8	SMP_LEV7	SMP_LEV6	SMP_LEV5	SMP_LEV4	SMP_LEV3	SMP_LEV2	0000
Bit7	Bit6	Bit5	Bit4	Bit3	Bit2	Bit1	Bit0	
Address: 0x1E,0x1F								

BUF_PAST

Reports the number of data packets lost since buffer has been filled. Reading the buffer contents, BUF_SMPLEV or BUF_PAST within 10 us from enabling or clearing the buffer is not permitted to avoid corrupted data. Data bytes BUF_PAST_L and BUF_PAST_H

R	R	R	R	R	R	R	R	Reset Value
SMP_PAST1	SMP_PAST0	Reserved	Reserved	Reserved	Reserved	Reserved	Reserved	0000
SMP_PAST9	SMP_PAST8	SMP_PAST7	SMP_PAST6	SMP_PAST5	SMP_PAST4	SMP_PAST3	SMP_PAST2	0000
Bit7	Bit6	Bit5	Bit4	Bit3	Bit2	Bit1	Bit0	
Address: 0x20,0x21								

AUX_STATUS

Reports the status of Auxiliary Sensors AUX1 and AUX2.

R	R	R	R	R	R	R	R	Reset Value
AUX2FAIL	AUX2ERR	AUX2ST1	AUX2ST0	AUX1FAIL	AUX1ERR	AUX1ST1	AUX1ST0	00000000
Bit7	Bit6	Bit5	Bit4	Bit3	Bit2	Bit1	Bit0	
Address: 0x22								

AUX1ST[1:0] - Detailed aux1 communication status.

2'b00: Aux1 sensor is disabled.

Aux1 has not been enabled or KXG03 has successfully sent disable cmd.

2'b01: Aux1 sensor is waiting to be enabled.

KXG03 is attempting to enable aux sensor via enable sequence.

2'b10: Aux1 sensor is waiting to be disabled.

KXG03 is attempting to disable aux sensor via disable sequence.

2'b11: Aux1 sensor is running.

KXG03 has successfully sent aux enable cmd.

AUX1ERR - Aux1 data read error flag.

	Digital Tri-axis Gyroscope/ Tri-axis Accelerometer Specifications	PART NUMBER KXG03-1034 Rev. 2.0 14-Feb-17
---	--	---

0: No error detected.

1: Missing ACK detected during aux1 polling. KXG03 will retry polling aux device at next scheduled ODR period.

Flag is cleared by writing (any value) into AUX_STATUS register.

AUX1FAIL - Aux1 command sequence failure flag.

0: No failure detected.

1: Missing ACK detected after writing control register address to aux1 device during enable/disable command sequence. KXG03 will suspend aux1 communications until AUX1FAIL bit is cleared by user.

Flag is cleared by writing (any value) into AUX_STATUS register.

AUX2ST[1:0] - Detailed aux2 communication status.

2'b00: Aux2 sensor is disabled.

Aux2 has not been enabled or KXG03 has successfully sent disable cmd.

2'b01: Aux2 sensor is waiting to be enabled.

KXG03 is attempting to enable aux sensor via enable sequence.

2'b10: Aux2 sensor is waiting to be disabled.

KXG03 is attempting to disable aux sensor via disable sequence.

2'b11: Aux2 sensor is running.

KXG03 has successfully sent aux enable cmd.

AUX2ERR – Aux2 data read error flag.

0: No error detected.

1: Missing ACK detected during aux2 polling. KXG03 will retry polling aux device at next scheduled ODR period.

Flag is cleared by writing (any value) into AUX_STATUS register.

AUX2FAIL – Aux2 command sequence failure flag.

0: No failure detected.

1: Missing ACK detected after writing control register address to aux2 device during enable/disable command sequence. KXG03 will suspend aux1 communications until AUX2FAIL bit is cleared by user.

Flag is cleared by writing (any value) into AUX_STATUS register.

	Digital Tri-axis Gyroscope/ Tri-axis Accelerometer Specifications	PART NUMBER
		KXG03-1034
		Rev. 2.0
		14-Feb-17

WHO_AM_I

This register can be used for supplier recognition, as it can be factory written to a known byte value. The default value is 0x24.

R	R	R	R	R	R	R	R	
WIA7	WIA6	WIA5	WIA4	WIA3	WIA2	WIA1	WIA0	Reset Value
Bit7	Bit6	Bit5	Bit4	Bit3	Bit2	Bit1	Bit0	00100100
Address:							0x30	

SN

Individual Identification (serial number). Data bytes SN_1, SN_2, SN_3, SN_4.

R/W	R/W	R/W	R/W	R/W	R/W	R/W	R/W	R/W
SN7	SN6	SN5	SN4	SN3	SN2	SN1	SN0	
SN15	SN14	SN13	SN12	SN11	SN10	SN9	SN8	
SN23	SN22	SN21	SN20	SN19	SN18	SN17	SN16	
SN31	SN30	SN29	SN28	SN27	SN26	SN25	SN24	
Bit7	Bit6	Bit5	Bit4	Bit3	Bit2	Bit1	Bit0	
Address:							0x31 – 0x34	

STATUS1

Status register 1. GYRO_START = 1 and GYRO_RUN = 0 at system startup and go to GYRO_START = 0 and GYRO_RUN = 1 as the output rate signals become valid; permanent GYRO_START = 1 and GYRO_RUN = 0 indicate a damage in the device.

R	R	R	R	R	R	R	R	
INT1	POR	AUX2_ACT	AUX1_ACT	AUX_ERR	WAKE/SLEEP	GYRO_RUN	GYRO_START	Reset Value
Bit7	Bit6	Bit5	Bit4	Bit3	Bit2	Bit1	Bit0	01000100
Address:							0x36	

INT1 - reports Logical OR of non-masked interrupt sources sent to INT1 pin.

0: No interrupt event.

1: Interrupt event.

POR - Reset indicator.

0: No reset has occurred since register was last read.

1: KXG03 has exited reset phase.

This bit is automatically cleared when the status register is read.

	Digital Tri-axis Gyroscope/ Tri-axis Accelerometer Specifications	PART NUMBER KXG03-1034 Rev. 2.0 14-Feb-17
---	--	---

AUX2_ACT - Auxiliary sensor #2 active flag.

0: Aux2 is not active. Aux2 has completed its disable sequence and is in standby mode.

1: Aux2 active. Aux2 has completed its enable sequence and is in active mode.

AUX1_ACT - Auxiliary sensor #1 active flag.

0: Aux1 is not active. Aux1 has completed its disable sequence and is in standby mode.

1: Aux1 active. Aux1 has completed its enable sequence and is in active mode.

AUX_ERR - Auxiliary communications error.

0: No aux communication error detected.

1: Aux communication error (missing ACK) detected.

Note:

- The user should read aux_stat register to determine state of aux sensors upon aux error detection.
- The flag can be cleared through writing any value to AUX_STATUS register

WAKE/SLEEP - Wake/sleep status flag.

0: Sleep mode.

1: Wake mode.

GYRO_RUN - Gyroscope run flag.

0: control loop has not locked.

1: control loop has locked and gyroscope is active.

GYRO_START - Gyroscope start-up flag.

0: Gyro not in start-up mode.

1: Start-up mode.

	Digital Tri-axis Gyroscope/ Tri-axis Accelerometer Specifications	PART NUMBER
		KXG03-1034
		Rev. 2.0
		14-Feb-17

INT1_SRC1

Interrupt 1 source register 1

R	R	R	R	R	R	R	R	R	
INT1_BFI	INT1_WMI	INT1_WUFS	INT1_BTS	INT1_DRDY_AUX2	INT1_DRDY_AUX1	INT1_DRDY_ACCTEMP	INT1_DRDY_GYRO	Reset Value	
Bit7	Bit6	Bit5	Bit4	Bit3	Bit2	Bit1	Bit0	00000000	
Address: 0x37									

INT1_BFI - Buffer full interrupt.

0: Buffer is not full.

1: Buffer is full.

This bit is cleared when the int1_I register is read or when the buffer full condition ceases to exist.

Please note: Re-enabling the buffer after the buffer had been disabled during a BFI event can cause the KXG03 to briefly output a false BFI flag.

INT1_WMI - Buffer water mark interrupt.

0: Watermark has not been reached.

1: Watermark has been reached.

This bit is cleared when the int1_I register is read or when the water mark condition ceases to exist.

Please note: Re-enabling the buffer after the buffer had been disabled during a WMI event can cause the KXG03 to briefly output a false WMI flag.

INT1_WUFS - Wake-up function interrupt.

0: No Wake-up event detected.

1: Wake-up event detected.

This bit is cleared when the int1_I register is read.

INT1_BTS – Back-to-sleep interrupt.

0: No back-to-sleep event detected.

1: Back-to-sleep event detected.

This bit is cleared when the int1_I register is read.

INT1_DRDY_AUX2 - Aux2 data ready interrupt.

0: New sensor data is not ready.

1: New sensor data is ready.

This bit is cleared when the int1_I register or when the aux2_out1 register is read.

INT1_DRDY_AUX1 – Aux1 data ready interrupt.

0: New sensor data is not ready.

	Digital Tri-axis Gyroscope/ Tri-axis Accelerometer Specifications	PART NUMBER KXG03-1034 Rev. 2.0 14-Feb-17
---	--	---

1: New sensor data is ready.
 This bit is cleared when the `int1_l` register or when the `aux1_out1` register is read.

INT1_DRDY_ACCTEMP – Accelerometer / Temperature data ready interrupt.

0: New sensor data is not ready.
 1: New sensor data is ready.

Note: With both accel and die temp enabled simultaneously, the die temp data updates at the same time as the accel data. With the accel disabled the availability of new die temp data uses the `drdy_acctemp` interrupt.
 This bit is cleared when the `int1_l` register or when the `acc_xout_l` register (x06) is read or when `temp_out_l` is read (if accel disabled).

INT1_DRDY_GYRO – Gyro data ready interrupt.

0: New sensor data is not ready.
 1: New sensor data is ready.

This bit is cleared when the `int1_l` register or when the `gyro_xout_l` register (x00) is read.

INT1_SRC2

Interrupt 1 source register 2

R	R	R	R	R	R	R	R	
Reserved	Reserved	INT1_XNWU	INT1_XPWU	INT1_YNWU	INT1_YPWU	INT1_ZNWU	INT1_ZPWU	Reset Value
Bit7	Bit6	Bit5	Bit4	Bit3	Bit2	Bit1	Bit0	00000000
Address: 0x38								

INT1_XNWU - WUF directional indicator bit.

0: no interrupt event.
 1: Wake-up event detected on x-axis, negative direction.

INT1_XPWU - WUF directional indicator bit.

0: no interrupt event.
 1: Wake-up event detected on x-axis, positive direction.

INT1_YNWU - WUF directional indicator bit.

0: no interrupt event.
 1: Wake-up event detected on y-axis, negative direction.

INT1_YPWU – WUF directional indicator bit.

0: no interrupt event.



Digital Tri-axis Gyroscope/ Tri-axis Accelerometer Specifications

PART NUMBER

KXG03-1034

Rev. 2.0

14-Feb-17

1: Wake-up event detected on y-axis, positive direction.

INT1_ZNWU - WUF directional indicator bit.

0: no interrupt event.

1: Wake-up event detected on z-axis, negative direction.

INT1_ZPWU – WUF directional indicator bit.

0: no interrupt event.

1: Wake-up event detected on z-axis, positive direction.

INT1_L

Interrupt 1 Latch Release – Reading the interrupt1 latch release register clears the interrupt1 source (int1_src1 and int1_src2) registers. Reading int1_l returns x00 in user mode.

R	R	R	R	R	R	R	R
0	0	0	0	0	0	0	0
Bit7	Bit6	Bit5	Bit4	Bit3	Bit2	Bit1	Bit0
							Address: 0x39

STATUS2

Status register 2. GYRO_START = 1 and GYRO_RUN = 0 at system startup and go to GYRO_START = 0 and GYRO_RUN = 1 as the output rate signals become valid; permanent GYRO_START = 1 and GYRO_RUN = 0 indicate a damage in the device.

R	R	R	R	R	R	R	R	
INT2	POR	AUX2_ACT	AUX1_ACT	AUX_ERR	WAKE/SLEEP	GYRO_RUN	GYRO_START	Reset Value
Bit7	Bit6	Bit5	Bit4	Bit3	Bit2	Bit1	Bit0	01000100
							Address:	0x3A

INT2 - reports Logical OR of non-masked interrupt sources sent to INT2 pin.

0: No interrupt event.

1: Interrupt event.

POR - Reset indicator.

0: No reset has occurred since register was last read.

1: KXG03 has exited reset phase.

This bit is automatically cleared when the status register is read.

AUX2_ACT - Auxiliary sensor #2 active flag.

0: Aux2 is not active. Aux2 has completed its disable sequence and is in standby mode.

1: Aux2 active. Aux2 has completed its enable sequence and is in active mode.



Digital Tri-axis Gyroscope/ Tri-axis Accelerometer Specifications

PART NUMBER

KXG03-1034

Rev. 2.0

14-Feb-17

AUX1_ACT - Auxiliary sensor #1 active flag.

0: Aux1 is not active. Aux1 has completed its disable sequence and is in standby mode.

1: Aux1 active. Aux1 has completed its enable sequence and is in active mode.

AUX_ERR - Auxiliary communications error.

0: No aux communication error detected.

1: Aux co communication mm error (missing ACK) detected.

Note: The user should read aux_stat register to determine state of aux sensors upon aux error detection.

WAKE/SLEEP - Wake/sleep status flag.

0: Sleep mode.

1: Wake mode.

GYRO_START - Gyroscope start-up flag.

0: Gyro not in startup mode.

1: Start up mode.

GYRO_RUN - Gyroscope run flag.

0: control loop has not locked.

1: control loop has locked and gyroscope is active.

INT2_SRC1

Interrupt 2 source register 1

R	R	R	R	R	R	R	R	Reset Value
INT2_BFI	INT2_WMI	INT2_WUFS	INT2_BTS	INT2_DRDY_AUX2	INT2_DRDY_AUX1	INT2_DRDY_ACCTEMP	INT2_DRDY_GYRO	00000000
Bit7	Bit6	Bit5	Bit4	Bit3	Bit2	Bit1	Bit0	
Address: 0x3B								

INT2_BFI - Buffer full interrupt.

0: Buffer is not full.

1: Buffer is full.

This bit is cleared when the int2_l register is read or when the buffer full condition ceases to exist.

Please note: Re-enabling the buffer after the buffer had been disabled during a BFI event can cause the KXG03 to briefly output a false BFI flag.

INT2_WMI - Buffer water mark interrupt.

	Digital Tri-axis Gyroscope/ Tri-axis Accelerometer Specifications	PART NUMBER KXG03-1034 Rev. 2.0 14-Feb-17
---	--	--

0: Watermark has not been reached.
1: Watermark has been reached.
This bit is cleared when the *int2_I* register is read or when the water mark condition ceases to exist.
Please note: Re-enabling the buffer after the buffer had been disabled during a WMI event can cause the KXG03 to briefly output a false WMI flag.

INT2_WUFS - Wake-up function interrupt.
0: No Wake-up event detected.
1: Wake-up event detected.
This bit is cleared when the *int2_I* register is read.

INT2_BTS – Back-to-sleep interrupt.
0: No back-to-sleep event detected.
1: Back-to-sleep event detected.
This bit is cleared when the *int2_I* register is read.

INT2_DRDY_AUX2 - Aux2 data ready interrupt.
0: New sensor data is not ready.
1: New sensor data is ready.
This bit is cleared when the *int2_I* register or when the *aux2_out1* register is read.

INT2_DRDY_AUX1 – Aux1 data ready interrupt.
0: New sensor data is not ready.
1: New sensor data is ready.
This bit is cleared when the *int2_I* register or when the *aux1_out1* register is read.

INT2_DRDY_ACCTEMP – Accelerometer data ready interrupt.
0: New sensor data is not ready.
1: New sensor data is ready.
Note: With both accel and die temp enabled simultaneously, the die temp data updates at the same time as the accel data. With the accel disabled the availability of new die temp data uses the *drdy_acctemp* interrupt.
This bit is cleared when the *int2_I* register or when the *acc_xout_I* register (x06) is read or when *temp_out_I* is read (if accel disabled).

INT2_DRDY_GYRO – Gyro data ready interrupt.
0: New sensor data is not ready.
1: New sensor data is ready.
This bit is cleared when the *int2_I* register or when the *gyro_xout_I* register (x00) is read.

	Digital Tri-axis Gyroscope/ Tri-axis Accelerometer Specifications	PART NUMBER
		KXG03-1034
		Rev. 2.0
		14-Feb-17

INT2_SRC2

Interrupt 2 source register 2

R	R	R	R	R	R	R	R	R
Reserved	Reserved	INT2_XNWU	INT2_XPWU	INT2_YNWU	INT2_YPWU	INT2_ZNWU	INT2_ZPWU	Reset Value
Bit7	Bit6	Bit5	Bit4	Bit3	Bit2	Bit1	Bit0	00000000
Address: 0x3C								

INT2_XNWU - WUF directional indicator bit.
0: no interrupt event.
1: Wake-up event detected on x-axis, negative direction.

INT2_XPWU - WUF directional indicator bit.
0: no interrupt event.
1: Wake-up event detected on x-axis, positive direction.

INT2_YNWU - WUF directional indicator bit.
0: no interrupt event.
1: Wake-up event detected on y-axis, negative direction.

INT2_YPWU – WUF directional indicator bit.
0: no interrupt event.
1: Wake-up event detected on y-axis, positive direction.

INT2_ZNWU - WUF directional indicator bit.
0: no interrupt event.
1: Wake-up event detected on z-axis, negative direction.

INT2_ZPWU – WUF directional indicator bit.
0: no interrupt event.
1: Wake-up event detected on z-axis, positive direction.



Digital Tri-axis Gyroscope/ Tri-axis Accelerometer Specifications

PART NUMBER

KXG03-1034

Rev. 2.0

14-Feb-17

INT2_L

Interrupt 2 Latch Release – Reading the interrupt2 latch release register clears the interrupt2 source (int1_src2 and int2_src2) registers. Reading int2_l returns x00 in user mode.

R	R	R	R	R	R	R	R
0	0	0	0	0	0	0	0
Bit7	Bit6	Bit5	Bit4	Bit3	Bit2	Bit1	Bit0
Address: 0x3D							

ACCEL_ODR_WAKE

Accelerometer Wake Mode Control register.

R/W	R/W	R/W	R/W	R/W	R/W	R/W	R/W	
LPMODE_W	NAVW_W2	NAVW_W1	NAVW_W0	ODRA_W3	ODRA_W2	ODRA_W1	ODRA_W0	Reset Value
Bit7	Bit6	Bit5	Bit4	Bit3	Bit2	Bit1	Bit0	11010110
Address: 0x3E								

LPMODE_W - Accelerometer wake state low power mode enable

0: Accelerometer low power mode is disabled in wake state.

Accelerometer operates at max sampling rate and navg_wake is ignored

1: Accelerometer low power mode is enabled in wake state

Accelerometer operates in duty cycle mode with number of samples set by navg_wake

Note: The LPMODE_W = 1 setting would be ignored and device would not operate in duty cycle mode when ODR for either accelerometer or gyro is set for 400Hz or higher.

NAVW_W[2:0]: Accelerometer wake mode OSR control. The max over sampling rate (or max number of samples averaged) varies with ODR.

[2]	[1]	[0]	Number of Averages
0	0	0	1
0	0	1	2
0	1	0	4
0	1	1	8
1	0	0	16
1	0	1	32
1	1	0	64
1	1	1	128



Digital Tri-axis Gyroscope/ Tri-axis Accelerometer Specifications

PART NUMBER

KXG03-1034

Rev. 2.0

14-Feb-17

ODRA_W[3:0]: Determines accelerometer ODR in wake mode

[3]	[2]	[1]	[0]	Output Data Rate
0	0	0	0	0.781Hz
0	0	0	1	1.563Hz
0	0	1	0	3.125Hz
0	0	1	1	6.25Hz
0	1	0	0	12.5Hz
0	1	0	1	25Hz
0	1	1	0	50Hz
0	1	1	1	100Hz
1	0	0	0	200Hz
1	0	0	1	400Hz
1	0	1	0	800Hz
1	0	1	1	1600Hz
1	1	0	0	3200Hz
1	1	0	1	6400Hz
1	1	1	0	12800Hz
1	1	1	1	51200Hz

ACCEL_ODR_SLEEP

Accelerometer Wake Mode Control register.

R/W	R/W	R/W	R/W	R/W	R/W	R/W	R/W	Reset Value
LPMODE_S	NAV_G_S2	NAV_G_S1	NAV_G_S0	ODRA_S3	ODRA_S2	ODRA_S1	ODRA_S0	11010110
Bit7	Bit6	Bit5	Bit4	Bit3	Bit2	Bit1	Bit0	
							Address:	0x3F

LPMODE_S - Accelerometer sleep state low power mode enable

0: Accelerometer low power mode is disabled in sleep state

Accelerometer operates at max sampling rate and *navg_sleep* is ignored

1: Accelerometer low power mode is enabled in sleep state

Accelerometer operates in duty cycle mode with number of samples set by *navg_sleep*

Note: The LPMODE_S = 1 setting would be ignored and device would not operate in duty cycle mode when ODR for either accelerometer or gyro is set for 400Hz or higher.



Digital Tri-axis Gyroscope/ Tri-axis Accelerometer Specifications

PART NUMBER

KXG03-1034

Rev. 2.0

14-Feb-17

NAVGS[2:0]: Accelerometer sleep mode OSR control. The max over sampling rate (or max number of samples averaged) varies with ODR.

[2]	[1]	[0]	Number of Averages
0	0	0	1
0	0	1	2
0	1	0	4
0	1	1	8
1	0	0	16
1	0	1	32
1	1	0	64
1	1	1	128

ODRAS[3:0]: Determines accelerometer ODR in sleep mode

[3]	[2]	[1]	[0]	Output Data Rate
0	0	0	0	0.781Hz
0	0	0	1	1.563Hz
0	0	1	0	3.125Hz
0	0	1	1	6.25Hz
0	1	0	0	12.5Hz
0	1	0	1	25Hz
0	1	1	0	50Hz
0	1	1	1	100Hz
1	0	0	0	200Hz
1	0	0	1	400Hz
1	0	1	0	800Hz
1	0	1	1	1600Hz
1	1	0	0	3200Hz
1	1	0	1	6400Hz
1	1	1	0	12800Hz
1	1	1	1	51200Hz

	Digital Tri-axis Gyroscope/ Tri-axis Accelerometer Specifications	PART NUMBER
		KXG03-1034
		Rev. 2.0
		14-Feb-17

ACCEL_CTL

Accelerometer range control register.

R/W	R/W	R/W	R/W	R/W	R/W	R/W	R/W	
ACC_FS_S1	ACC_FS_S0	Reserved	Reserved	ACC_FS_W1	ACC_FS_W0	Reserved	Reserved	Reset Value
Bit7	Bit6	Bit5	Bit4	Bit3	Bit2	Bit1	Bit0	00000000
Address: 0x40								

ACC_FS_S[1:0] Accelerometer sleep mode full scale range select

- 2'b00: ± 2 g
- 2'b01: ± 4 g,
- 2'b10: ± 8 g,
- 2'b11: ± 16 g

ACC_FS_W[1:0] Accelerometer wake mode full scale range select

- 2'b00: ± 2 g
- 2'b01: ± 4 g,
- 2'b10: ± 8 g,
- 2'b11: ± 16 g

GYRO_ODR_WAKE

Gyroscope Wake Mode Control register.

R/W	R/W	R/W	R/W	R/W	R/W	R/W	R/W	
GYRO_FS_W1	GYRO_FS_W0	GYRO_BW_W1	GYRO_BW_W0	ODRG_W3	ODRG_W2	ODRG_W1	ODRG_W0	Reset Value
Bit7	Bit6	Bit5	Bit4	Bit3	Bit2	Bit1	Bit0	00000110
Address: 0x41								

GYRO_FS_W[1:0]: Gyroscope angular velocity range wake mode

[1]	[0]	Range
0	0	±256
0	1	±512
1	0	±1024
1	1	±2048



Digital Tri-axis Gyroscope/ Tri-axis Accelerometer Specifications

PART NUMBER

KXG03-1034

Rev. 2.0

14-Feb-17

GYRO_BW_W[1:0]: Gyroscope bandwidth selection in wake mode

[1]	[0]	BW
0	0	10 Hz
0	1	20 Hz
1	0	40 Hz
1	1	160 Hz

ODRG_W[3:0]: Determines gyroscope ODR in wake mode

[3]	[2]	[1]	[0]	Output Data Rate
0	0	0	0	0.781Hz
0	0	0	1	1.563Hz
0	0	1	0	3.125Hz
0	0	1	1	6.25Hz
0	1	0	0	12.5Hz
0	1	0	1	25Hz
0	1	1	0	50Hz
0	1	1	1	100Hz
1	0	0	0	200Hz
1	0	0	1	400Hz
1	0	1	0	800Hz
1	0	1	1	1600Hz
1	1	0	0	1600Hz
1	1	0	1	1600Hz
1	1	1	0	1600Hz
1	1	1	1	1600Hz



Digital Tri-axis Gyroscope/ Tri-axis Accelerometer Specifications

PART NUMBER

KXG03-1034

Rev. 2.0

14-Feb-17

GYRO_ODR_SLEEP

Gyroscope Sleep Mode Control register.

R/W	R/W	R/W	R/W	R/W	R/W	R/W	R/W	
GYRO_FS_S1	GYRO_FS_S0	GYRO_BW_S1	GYRO_BW_S0	ODRG_S3	ODRG_S2	ODRG_S1	ODRG_S0	Reset Value
Bit7	Bit6	Bit5	Bit4	Bit3	Bit2	Bit1	Bit0	00000110
Address: 0x42								

GYRO_FS_S[1:0]: Gyroscope angular velocity range in sleep mode

[1]	[0]	Range
0	0	±256
0	1	±512
1	0	±1024
1	1	±2048

GYRO_BW_S[1:0]: Gyroscope bandwidth selection in sleep mode

[1]	[0]	BW
0	0	10 Hz
0	1	20 Hz
1	0	40 Hz
1	1	160 Hz



Digital Tri-axis Gyroscope/ Tri-axis Accelerometer Specifications

PART NUMBER

KXG03-1034

Rev. 2.0

14-Feb-17

ODRG_S[3:0]: Determines gyroscope ODR in sleep mode

[3]	[2]	[1]	[0]	Output Data Rate
0	0	0	0	0.781Hz
0	0	0	1	1.563Hz
0	0	1	0	3.125Hz
0	0	1	1	6.25Hz
0	1	0	0	12.5Hz
0	1	0	1	25Hz
0	1	1	0	50Hz
0	1	1	1	100Hz
1	0	0	0	200Hz
1	0	0	1	400Hz
1	0	1	0	800Hz
1	0	1	1	1600Hz
1	1	0	0	1600Hz
1	1	0	1	1600Hz
1	1	1	0	1600Hz
1	1	1	1	1600Hz

	Digital Tri-axis Gyroscope/ Tri-axis Accelerometer Specifications	PART NUMBER
		KXG03-1034
		Rev. 2.0
		14-Feb-17

STDBY

Stand-by and operational control register. KXG03 register settings can be applied prior to enabling the Accel or Gyro. Enabling the sensor “locks in” the user register settings. Altering register settings after enable is not recommended.

R/W	R/W	R/W	R/W	R/W	R/W	R/W	R/W	
AUX2_STD BY_S	AUX1_STD BY_S	GYRO_STD BY_S	Reserved	AUX2_STD BY_W	AUX1_STD BY_W	GYRO_STD BY_W	ACC_STDBY	Reset Value
Bit7	Bit6	Bit5	Bit4	Bit3	Bit2	Bit1	Bit0	11101111
Address: 0x43								

AUX2_STDBY_S - Active LOW aux2 sensor enable

0: Aux2 sensor is enabled in sleep state

1: Aux2 sensor is disabled in sleep state

AUX1_STDBY_S - Active LOW aux1 sensor enable

0: Aux1 sensor is enabled in sleep state

1: Aux1 sensor is disabled in sleep state

GYRO_STDBY_S - Active LOW gyroscope sensor enable

0: Gyro sensor is enabled in sleep state

1: Gyro sensor is disabled in sleep state

AUX2_STDBY_W - Active LOW aux2 sensor enable

0: Aux2 sensor is enabled in wake state

1: Aux2 sensor is disabled in wake state

AUX1_STDBY_W - Active LOW aux1 sensor enable

0: Aux1 sensor is enabled in wake state

1: Aux1 sensor is disabled in wake state

GYRO_STDBY_W - Active LOW gyroscope sensor enable

0: Gyro sensor is enabled in wake state

1: Gyro sensor is disabled in wake state

ACC_STDBY - Active LOW Accelerometer sensor enable.

0: Accelerometer sensor is enabled

1: Accelerometer sensor is disabled

	Digital Tri-axis Gyroscope/ Tri-axis Accelerometer Specifications	PART NUMBER
		KXG03-1034
		Rev. 2.0
		14-Feb-17

CTL_REG_1

Special control register 1.

R/W	R/W	R/W	R/W	R/W	R/W	R/W	R/W	Reset Value
SRST	Reserved	I2C_DIS	TEMP_STDBY_S	TEMP_STDBY_W	Reserved	ACC_STPOL	ACC_ST	00011000
Bit7	Bit6	Bit5	Bit4	Bit3	Bit2	Bit1	Bit0	
Address: 0x44								

SRST - initiates software reset, which performs the RAM reboot routine. This bit will remain 1 until the RAM reboot routine is finished.

SRST = 0 – no action

SRST = 1 – start RAM reboot routine. This bit is self-clearing.

I2C_DIS - Active high I2C disable bit.

0: I2C interface is not disabled.

1: I2C interface is disabled.

Please note the I2C_DIS control bit defaults to 0 on power up or when exiting reset. The state of this bit can only be changed via SPI communications.

For applications using SPI on a shared bus (multiple slave devices on a single nCS line)

I2C_DIS should be set 1. Applications using a SPI interface on a dedicated bus (nCS

connects only to KXG03 and not to any other slave devices) can function with I2C_DIS set to 0 or 1. For applications using I2C interface I2C_DIS should be set 0.

TEMP_STDBY_S - Sleep mode temperature output standby bit.

0: Temperature output is enabled in sleep mode.

1: Temperature output is disabled in sleep mode.

Note: Temperature output operates with the same ODR as the Accelerometer.

TEMP_STDBY_W - Wake mode temperature output standby bit.

0: Temperature output is enabled in wake mode.

1: Temperature output is disabled in wake mode.

Note: Temperature output operates with the same ODR as the Accelerometer.

ACC_STPOL - Defines accelerometer self-test polarity.

0: Accelerometer self-test polarity is not inverted.

1: Accelerometer self-test polarity is inverted.

ACC_ST - Active high accelerometer self-test enable

0: Accelerometer self-test is disabled.

1: Accelerometer self-test is enabled.

	Digital Tri-axis Gyroscope/ Tri-axis Accelerometer Specifications	PART NUMBER
		KXG03-1034
		Rev. 2.0
		14-Feb-17

INT_PIN_CTL

This register controls the settings for the physical interrupt pins INT1 and INT2.

R/W	R/W	R/W	R/W	R/W	R/W	R/W	R/W	
IEN2	IEA2	IEL2_1	IEL2_0	IEN1	IEA1	IEL1_1	IEL1_0	Reset Value
Bit7	Bit6	Bit5	Bit4	Bit3	Bit2	Bit1	Bit0	01000100
Address: 0x45								

IEN2 - Active high enable for INT2 pin.

0: INT2 pin is disabled and output is forced to non-asserted state.

1: INT2 pin is enabled. Output state is either high or low depending on status of selected interrupt sources.

IEA2 - Interrupt polarity select for INT2 pin.

0: INT2 is active low. Pin pulls low during interrupt event.

1: INT2 is active high. Pin pulls high during interrupt event.

IEL2[1:0]: Interrupt latch mode select for INT2 pin.

2'b00: Latched. Once an interrupt has triggered INT2 remains in its interrupt state defined by IEA2 until the interrupt source has been cleared.

2'b01: Pulsed. Once an interrupt has triggered INT2 remains in its interrupt state defined by IEA2 for an approximate period of 40 us before returning to the non-interrupt state.

2'b10: Pulsed. Once an interrupt has triggered INT2 remains in its interrupt state defined by IEA2 for an approximate period of 160 us before returning to the non-interrupt state.

2'b11: Real time mode. INT2 only remains asserted as long as underlying interrupt conditions exist.

IEN1 - Active high enable for INT1 pin.

0: INT1 pin is disabled and output is forced to non-asserted state.

1: INT1 pin is enabled. Output state is either high or low depending on status of selected interrupt sources.

IEA1 - Interrupt polarity select for INT1 pin.

0: INT1 is active low. Pin pulls low during interrupt event.

1: INT1 is active high. Pin pulls high during interrupt event.

IEL1[1:0]: Interrupt latch mode select for INT1 pin.

2'b00: Latched. Once an interrupt has triggered INT1 remains in its interrupt state defined by IEA2 until the interrupt source has been cleared.

2'b01: Pulsed. Once an interrupt has triggered INT1 remains in its interrupt state defined by IEA2 for an approximate period of 40 us before returning to the non-interrupt state.



Digital Tri-axis Gyroscope/ Tri-axis Accelerometer Specifications

PART NUMBER

KXG03-1034

Rev. 2.0

14-Feb-17

2'b10: Pulsed. Once an interrupt has triggered INT1 remains in its interrupt state defined by IEA2 for an approximate period of 160 us before returning to the non-interrupt state.

2'b11: Real time mode. INT1 only remains asserted as long as underlying interrupt conditions exist.

INT_PIN1_SEL

Physical interrupt pin INT1 select register.

R/W	R/W	R/W	R/W	R/W	R/W	R/W	R/W	Reset Value
BFI_P1	WMI_P1	WUF_P1	BTS_P1	DRDY_AUX2_P1	DRDY_AUX1_P1	DRDY_ACCT_EMP_P1	DRDY_GYRO_P1	11111111
Bit7	Bit6	Bit5	Bit4	Bit3	Bit2	Bit1	Bit0	
Address: 0x46								

BFI_P1 – Buffer Full Interrupt for INT1 pin.

0: Corresponding interrupt is not routed to INT1 pin.

1: Corresponding interrupt is routed to INT1 pin.

WMI_P1 – Water Mark Interrupt for INT1 pin.

0: Corresponding interrupt is not routed to INT1 pin.

1: Corresponding interrupt is routed to INT1 pin.

WUF_P1 – Wake-up Function Interrupt for INT1 pin.

0: Corresponding interrupt is not routed to INT1 pin.

1: Corresponding interrupt is routed to INT1 pin.

BTS_P1 – Back-to-sleep Function Interrupt for INT1 pin.

0: Corresponding interrupt is not routed to INT1 pin.

1: Corresponding interrupt is routed to INT1 pin.

DRDY_AUX2_P1 – Data Ready Aux2 Interrupt for INT1 pin.

0: Corresponding interrupt is not routed to INT1 pin.

1: Corresponding interrupt is routed to INT1 pin.

DRDY_AUX1_P1 – Data Ready AUX1 Interrupt for INT1 pin.

0: Corresponding interrupt is not routed to INT1 pin.

1: Corresponding interrupt is routed to INT1 pin.

DRDY_ACCTEMP_P1 – Data Ready Accelerometer / Temperature Interrupt for INT1 pin.

0: Corresponding interrupt is not routed to INT1 pin.

1: Corresponding interrupt is routed to INT1 pin.

	Digital Tri-axis Gyroscope/ Tri-axis Accelerometer Specifications	PART NUMBER
		KXG03-1034
		Rev. 2.0
		14-Feb-17

DRDY_GYRO_P1 – Data Ready Gyroscope Interrupt for INT1 pin.
0: Corresponding interrupt is not routed to INT1 pin.
1: Corresponding interrupt is routed to INT1 pin.

INT_PIN2_SEL

Physical interrupt pin INT2 select register.

R/W	R/W	R/W	R/W	R/W	R/W	R/W	R/W	R/W	Reset Value
BFI_P2	WMI_P2	WUF_P2	BTS_P2	DRDY_AUX2_P2	DRDY_AUX1_P2	DRDY_ACCTEMP_P2	DRDY_GYRO_P2		00000000
Bit7	Bit6	Bit5	Bit4	Bit3	Bit2	Bit1	Bit0		
Address: 0x47									

BFI_P2 – Buffer Full Interrupt for INT2 pin.
0: Corresponding interrupt is not routed to INT2 pin.
1: Corresponding interrupt is routed to INT2 pin.

WMI_P2 – Water Mark Interrupt for INT2 pin.
0: Corresponding interrupt is not routed to INT2 pin.
1: Corresponding interrupt is routed to INT2 pin.

WUF_P2 – Wake-up Function Interrupt for INT2 pin.
0: Corresponding interrupt is not routed to INT2 pin.
1: Corresponding interrupt is routed to INT2 pin.

BTS_P2 – Back-to-sleep Function Interrupt for INT2 pin.
0: Corresponding interrupt is not routed to INT2 pin.
1: Corresponding interrupt is routed to INT2 pin.

DRDY_AUX2_P2 – Data Ready Aux2 Interrupt for INT2 pin.
0: Corresponding interrupt is not routed to INT2 pin.
1: Corresponding interrupt is routed to INT2 pin.

DRDY_AUX1_P2 – Data Ready AUX1 Interrupt for INT2 pin.
0: Corresponding interrupt is not routed to INT2 pin.
1: Corresponding interrupt is routed to INT2 pin.

DRDY_ACCTEMP_P2 – Data Ready Accelerometer / Temperature Interrupt for INT2 pin.
0: Corresponding interrupt is not routed to INT2 pin.
1: Corresponding interrupt is routed to INT2 pin.

	Digital Tri-axis Gyroscope/ Tri-axis Accelerometer Specifications	PART NUMBER
		KXG03-1034
		Rev. 2.0
		14-Feb-17

DRDY_GYRO_P2 – Data Ready Gyroscope Interrupt for INT2 pin.
0: Corresponding interrupt is not routed to INT2 pin.
1: Corresponding interrupt is routed to INT2 pin.

INT_MASK1

Interrupt mask register 1.

R/W	R/W	R/W	R/W	R/W	R/W	R/W	R/W	Reset Value
BFIE	WMIE	WUFE	BTSE	DRDY_AUX2	DRDY_AUX1	DRDY_ACCT EMP	DRDY_GYRO	11000000
Bit7	Bit6	Bit5	Bit4	Bit3	Bit2	Bit1	Bit0	
Address: 0x48								

BFIE – Buffer Full Interrupt enable/mask bit.
0: Corresponding interrupt is disabled (masked).
1: Corresponding interrupt is enabled.

WMIE – Water Mark Interrupt enable/mask bit.
0: Corresponding interrupt is disabled (masked).
1: Corresponding interrupt is enabled.

WUFE – Wake-up Function Interrupt enable/mask bit.
0: Corresponding interrupt is disabled (masked).
1: Corresponding interrupt is enabled.

BTSE – Back-to-sleep Function Interrupt enable/mask bit.
0: Corresponding interrupt is disabled (masked). 1: Corresponding interrupt is routed to INT1 pin.

DRDY_AUX2 – Data Ready Aux2 Interrupt enable/mask bit.
0: Corresponding interrupt is disabled (masked).
1: Corresponding interrupt is enabled.

DRDY_AUX1 – Data Ready AUX1 Interrupt enable/mask bit.
0: Corresponding interrupt is disabled (masked).
1: Corresponding interrupt is enabled.

DRDY_ACCTEMP – Data Ready Accelerometer / Temperature Interrupt enable/mask bit.
0: Corresponding interrupt is disabled (masked).
1: Corresponding interrupt is enabled.

	Digital Tri-axis Gyroscope/ Tri-axis Accelerometer Specifications	PART NUMBER
		KXG03-1034
		Rev. 2.0
		14-Feb-17

DRDY_GYRO – Data Ready Gyroscope Interrupt enable/mask bit.
0: Corresponding interrupt is disabled (masked).
1: Corresponding interrupt is enabled.

INT_MASK2

Interrupt mask register 2. This register controls which axis and direction of detected motion can cause an interrupt.

R/W	R/W	R/W	R/W	R/W	R/W	R/W	R/W	
Reserved	Reserved	XNWUE	XPWUE	YNWUE	YPWUE	ZNWUE	ZPWUE	Reset Value
Bit7	Bit6	Bit5	Bit4	Bit3	Bit2	Bit1	Bit0	00111111
Address: 0x49								

NXWUE - x negative (x-) mask for WUF/BTS, 0=disable, 1=enable.
PXWUE - x positive (x+) mask for WUF/BTS, 0=disable, 1=enable.
NYWUE - y negative (y-) mask for WUF/BTS, 0=disable, 1=enable.
PYWUE - y positive (y+) mask for WUF/BTS, 0=disable, 1=enable.
NZWUE - z negative (z-) mask for WUF/BTS, 0=disable, 1=enable.
PZWUE - z positive (z+) mask for WUF/BTS, 0=disable, 1=enable.

FSYNC_CTL

External Synchronous control register.

R/W	R/W	R/W	R/W	R/W	R/W	R/W	R/W	
Reserved	Reserved	FSYNC_MODE1	FSYNC_MODE2	Reserved	FSYNC_SEL2	FSYNC_SEL1	FSYNC_SEL0	Reset Value
Bit7	Bit6	Bit5	Bit4	Bit3	Bit2	Bit1	Bit0	00000000
Address: 0x4A								

FSYNC_MODE[1:0]: FSYNC enable and mode select.
2'b00: FSYNC is disabled. SYNC pin is tri-stated.
2'b01: FSYNC is enabled. Sync pin is configured as input pin.
Buffer is updated in sync with external clock applied at SYNC pin.
2'b10: FSYNC is enabled. Sync pin is configured as input pin.
State of SYNC pin is stored in selected sensor's LSB bit.
2'b11: FSYNC is disabled. SYNC pin is configured as output pin.

FSYNC_SEL[2:0]: FSYNC sensor select bits.
if(fsycn_mode=2'b10)
3'b000: SYNC function disabled.



Digital Tri-axis Gyroscope/ Tri-axis Accelerometer Specifications

PART NUMBER

KXG03-1034

Rev. 2.0

14-Feb-17

3'b001: State of SYNC pin is stored in gyroscope's x LSB bit.
 3'b010: State of SYNC pin is stored in gyroscope's y LSB bit.
 3'b011: State of SYNC pin is stored in gyroscope's z LSB bit
 3'b100: State of SYNC pin is stored in accelerometer's x LSB bit.
 3'b101: State of SYNC pin is stored in accelerometer's y LSB bit.
 3'b110: State of SYNC pin is stored in accelerometer's z LSB bit.
 3'b111: State of SYNC pin is stored in temperature LSB bit
 if(fsync_mode=2'b11)
 3'b000: SYNC pin outputs gyroscope ODR clock.
 3'b001: SYNC pin outputs accelerometer's ODR clock.
 3'b010: SYNC pin outputs aux1 ODR clock.
 3'b011: SYNC pin outputs aux2 ODR clock.
 3'b1xx: SYNC pin disabled.

WAKE_SLEEP_CTL1

Wake and Sleep control register 1.

R/W	R/W	R/W	R/W	R/W	R/W	R/W	R/W	Reset Value
BTS_EN	WUF_EN	MAN_SLEEP	MAN_WAKE	Reserved	OWUF2	OWUF1	OWUF0	00000000
Bit7	Bit6	Bit5	Bit4	Bit3	Bit2	Bit1	Bit0	
Address: 0x4B								

BTS_EN - Active high back-to-sleep function enable.

0: Back-to-sleep transition for all sensors is not controlled by BTS function.

1: Back-to-sleep transition for all sensors is controlled by BTS function.

WUF_EN - Active high wake-up function enable.

0: Sleep-to-wake transition for all sensors is not controlled by BTS function.

1: Sleep-to-wake transition for all sensors is controlled by BTS function.

MAN_SLEEP - Active high manual sleep trigger.

0: No impact.

1: Forces transition to sleep state.

Please note:

Man_sleep is a self-clearing bit. The bit is cleared automatically after transition to sleep state.

Forcing a manual sleep state does not trigger WUFS or BTS interrupts.

Setting both man_sleep=1 and man_wake=1 is ignored.

MAN_WAKE - Active high manual wake trigger.

0: No impact.

1: Forces transition to wake state.

	Digital Tri-axis Gyroscope/ Tri-axis Accelerometer Specifications	PART NUMBER
		KXG03-1034
		Rev. 2.0
		14-Feb-17

Please note:

Man_sleep is a self-clearing bit. The bit is cleared automatically after transition to sleep state.

Forcing a manual sleep state does not trigger WUFS or BTS interrupts.

Setting both man_sleep=1 and man_wake=1 is ignored.

OWUF[2:0]: sets the Output Data Rate for the Wake-up (motion detection).

[2]	[1]	[0]	Output Data Rate (Hz)
0	0	0	0.781
0	0	1	1.563
0	1	0	3.125
0	1	1	6.25
1	0	0	12.5
1	0	1	25
1	1	0	50
1	1	1	100

WAKE_SLEEP_CTL2

Wake and Sleep control register 1.

R/W	R/W	R/W	R/W	R/W	R/W	R/W	R/W	Reset Value
Reserved	Reserved	Reserved	Reserved	Reserved	Reserved	TH_MODE	C_MODE	00000010
Bit7	Bit6	Bit5	Bit4	Bit3	Bit2	Bit1	Bit0	
Address: 0x4C								

TH_MODE - Defines WUF and BTS threshold mode.

0: Absolute threshold. KXG03 compares current output to threshold.

1: Relative threshold. KXG03 compares difference between current output and previous output to threshold.

C_MODE - Defines de-bounce counter clear mode.

0: Counter is cleared once activity level is outside the threshold.

1: Counter is decremented by one when activity level is outside the threshold.

WUF_TH

This register sets the Active Threshold for wake-up (motion detect) interrupt. The KXG03 will ship from the factory with this value set to correspond to a change in acceleration of 0.5g.

Resolution = 62.5 mg/LSB for FS < ± 16 g.

Resolution = 125 mg/LSB for FS = ± 16 g.



Digital Tri-axis Gyroscope/ Tri-axis Accelerometer Specifications

PART NUMBER

KXG03-1034

Rev. 2.0

14-Feb-17

R/W	R/W	R/W	R/W	R/W	R/W	R/W	R/W	Reset Value
ATH_7	ATH_6	ATH_5	ATH_4	ATH_3	ATH_2	ATH_1	ATH_0	00001000
Bit7	Bit6	Bit5	Bit4	Bit3	Bit2	Bit1	Bit0	
Address: 0x4D								

WUF_COUNTER

This register sets the time motion must be present before a wake-up interrupt is set. Every count is calculated as 1/OWUF delay period. OWUF is set in WAKE_SLEEP_CTL1.

Note: Setting the register to 0xFF disables the WUF_COUNTER.

R/W	R/W	R/W	R/W	R/W	R/W	R/W	R/W	Reset Value
WUFC7	WUFC6	WUFC5	WUFC4	WUFC3	WUFC2	WUFC1	WUFC0	00000000
Bit7	Bit6	Bit5	Bit4	Bit3	Bit2	Bit1	Bit0	
Address: 0x4E								

BTS_TH

This register sets the threshold for Back-to-sleep (motion detect) interrupt. The KXG03 will ship from the factory with this value set to correspond to a change in acceleration of 0.5g.

Resolution = 62.5 mg/LSB for FS < ± 16 g.

Resolution = 125 mg/LSB for FS = ± 16 g.

R/W	R/W	R/W	R/W	R/W	R/W	R/W	R/W	Reset Value
BTH_7	BTH_6	BTH_5	BTH_4	BTH_3	BTH_2	BTH_1	BTH_0	00001000
Bit7	Bit6	Bit5	Bit4	Bit3	Bit2	Bit1	Bit0	
Address: 0x4F								

BTS_COUNTER

This register sets the time motion must be present before a Back-to-sleep interrupt is set. Every count is calculated as 16/OWUF delay period. OWUF is set in WAKE_SLEEP_CTL1.

Note: Setting the register to 0xFF disables the BTS_COUNTER.

R/W	R/W	R/W	R/W	R/W	R/W	R/W	R/W	Reset Value
BTSC7	BTSC6	BTSC5	BTSC4	BTSC3	BTSC2	BTSC1	BTSC0	00000000
Bit7	Bit6	Bit5	Bit4	Bit3	Bit2	Bit1	Bit0	
Address: 0x50								

	Digital Tri-axis Gyroscope/ Tri-axis Accelerometer Specifications	PART NUMBER
		KXG03-1034
		Rev. 2.0
		14-Feb-17

AUX_I2C_CTL_REG
Read/Write control register.

R/W	R/W	R/W	R/W	R/W	R/W	R/W	R/W	Reset Value
Reserved	Reserved	AUX_CTL_POL2	AUX_CTL_POL1	AUX_BUS_SPD	AUX_PULL_UP	AUX_BYPASS	Reserved	00000010
Bit7	Bit6	Bit5	Bit4	Bit3	Bit2	Bit1	Bit0	
Address: 0x51								

AUX_CTL_POL2 - Defines control bit polarity for aux2 enable/disable command sequences.
0: KXG03 clears selected control bits when enabling auxiliary-2 sensor and KXG03 sets to 1 selected control bits when disabling aux2 sensor.
1: KXG03 sets to 1 selected control bits when enabling auxiliary-2 sensor and KXG03 clears selected control bits when disabling aux2 sensor.

AUX_CTL_POL1 - Defines control bit polarity for aux1 enable/disable command sequences.
0: KXG03 clears selected control bits when enabling auxiliary-1 sensor and KXG03 sets to 1 selected control bits when disabling aux1 sensor.
1: KXG03 sets to 1 selected control bits when enabling auxiliary-1 sensor and KXG03 clears selected control bits when disabling aux1 sensor.

AUX_BUS_SPD- Sets I2C bus speed.
0: 100 kHz,
1: 400 kHz

AUX_PULL_UP - Active high pull up enable.
0: Pull up disabled.
1: 1.5KΩ pull up resistor enabled.
Please note the pull up resistor is automatically disabled when aux_bypass=1 even though aux_pull_up may be set to 1.

AUX_BYPASS – Active high bypass enable
0: Aux I2C not bypassed
1: Aux I2C pins shorted to main (slave) I2C pins. Pull up disabled



Digital Tri-axis Gyroscope/ Tri-axis Accelerometer Specifications

PART NUMBER

KXG03-1034

Rev. 2.0

14-Feb-17

AUX_I2C_SAD1

Read/Write that should be used to store the SAD for auxiliary I²C device 1.

R/W	R/W	R/W	R/W	R/W	R/W	R/W	R/W	Reset Value
SAD1_6	SAD1_5	SAD1_4	SAD1_3	SAD1_2	SAD1_1	SAD1_0	-	00000000
Bit7	Bit6	Bit5	Bit4	Bit3	Bit2	Bit1	Bit0	
Address: 0x52								

AUX_I2C_REG1

Read/Write that should be used to store the starting data register address for auxiliary I²C device 1.

R/W	R/W	R/W	R/W	R/W	R/W	R/W	R/W	Reset Value
REG1_7	REG1_6	REG1_5	REG1_4	REG1_3	REG1_2	REG1_1	REG1_0	00000000
Bit7	Bit6	Bit5	Bit4	Bit3	Bit2	Bit1	Bit0	
Address: 0x53								

AUX_I2C_CTL1

Register address for enable/disable control register for auxiliary I²C device 1.

R/W	R/W	R/W	R/W	R/W	R/W	R/W	R/W	Reset Value
CNTL1_7	CNTL1_6	CNTL1_5	CNTL1_4	CNTL1_3	CNTL1_2	CNTL1_1	CNTL1_0	00000000
Bit7	Bit6	Bit5	Bit4	Bit3	Bit2	Bit1	Bit0	
Address: 0x54								

AUX_I2C_BIT1

Defines bits to toggle in the control register for auxiliary I²C device 1.

R/W	R/W	R/W	R/W	R/W	R/W	R/W	R/W	Reset Value
BIT1_7	BIT1_6	BIT1_5	BIT1_4	BIT1_3	BIT1_2	BIT1_1	BIT1_0	00000000
Bit7	Bit6	Bit5	Bit4	Bit3	Bit2	Bit1	Bit0	
Address: 0x55								



Digital Tri-axis Gyroscope/ Tri-axis Accelerometer Specifications

PART NUMBER

KXG03-1034

Rev. 2.0

14-Feb-17

AUX_I2C_ODR1_W

Defines register read controls for auxiliary I²C device 1.

R/W	R/W	R/W	R/W	R/W	R/W	R/W	R/W	Reset Value
Reserved	AUX1_D2	AUX1_D1	AUX1_D0	AUX1ODRW3	AUX1ODRW2	AUX1ODRW1	AUX1ODRW0	00000110
Bit7	Bit6	Bit5	Bit4	Bit3	Bit2	Bit1	Bit0	
Address: 0x56								

AUX1_D[2:0]: Number of bytes read back via Auxiliary I²C bus from device 1

[2]	[1]	[0]	No. of
0	0	0	0
0	0	1	1
0	1	0	2
0	1	1	3
1	0	0	4
1	0	1	5
1	1	0	6
1	1	1	DNE

AUX1ODRW[3:0]: Determines rate at which aux1 output is polled by KXG03 in aux1 wake state

[3]	[2]	[1]	[0]	Output Data Rate
0	0	0	0	0.781Hz
0	0	0	1	1.563Hz
0	0	1	0	3.125Hz
0	0	1	1	6.25Hz
0	1	0	0	12.5Hz
0	1	0	1	25Hz
0	1	1	0	50Hz
0	1	1	1	100Hz
1	0	0	0	200Hz
1	0	0	1	400Hz
1	0	1	0	800Hz
1	0	1	1	1600Hz
1	1	0	0	1600Hz
1	1	0	1	1600Hz
1	1	1	0	1600Hz
1	1	1	1	1600Hz

	Digital Tri-axis Gyroscope/ Tri-axis Accelerometer Specifications	PART NUMBER
		KXG03-1034
		Rev. 2.0
		14-Feb-17

AUX_I2C_ODR1_S

Defines register read controls for auxiliary I²C device 1.

R/W	R/W	R/W	R/W	R/W	R/W	R/W	R/W	Reset Value
Reserved	Reserved	Reserved	Reserved	AUX1ODRS3	AUX1ODRS2	AUX1ODRS1	AUX1ODRS0	00000110
Bit7	Bit6	Bit5	Bit4	Bit3	Bit2	Bit1	Bit0	
Address: 0x57								

AUX1ODRS[3:0]: Determines rate at which aux1 output is polled by KXG03 in aux1 sleep state

[3]	[2]	[1]	[0]	Output Data Rate
0	0	0	0	0.781Hz
0	0	0	1	1.563Hz
0	0	1	0	3.125Hz
0	0	1	1	6.25Hz
0	1	0	0	12.5Hz
0	1	0	1	25Hz
0	1	1	0	50Hz
0	1	1	1	100Hz
1	0	0	0	200Hz
1	0	0	1	400Hz
1	0	1	0	800Hz
1	0	1	1	1600Hz
1	1	0	0	1600Hz
1	1	0	1	1600Hz
1	1	1	0	1600Hz
1	1	1	1	1600Hz

AUX_I2C_SAD2

Read/Write that should be used to store the SAD for auxiliary I²C device 2.

R/W	R/W	R/W	R/W	R/W	R/W	R/W	R/W	Reset Value
SAD2_6	SAD2_5	SAD2_4	SAD2_3	SAD2_2	SAD2_1	SAD2_0	-	00000000
Bit7	Bit6	Bit5	Bit4	Bit3	Bit2	Bit1	Bit0	
Address: 0x58								



Digital Tri-axis Gyroscope/ Tri-axis Accelerometer Specifications

PART NUMBER

KXG03-1034

Rev. 2.0

14-Feb-17

AUX_I2C_REG2

Read/Write that should be used to store the starting data register address for auxiliary I²C device 2.

R/W	R/W	R/W	R/W	R/W	R/W	R/W	R/W	Reset Value
REG2_7	REG2_6	REG2_5	REG2_4	REG2_3	REG2_2	REG2_1	REG2_0	00000000
Bit7	Bit6	Bit5	Bit4	Bit3	Bit2	Bit1	Bit0	
Address: 0x59								

AUX_I2C_CTL2

Register address for enable/disable control register for auxiliary I²C device 2.

R/W	R/W	R/W	R/W	R/W	R/W	R/W	R/W	Reset Value
CNTL2_7	CNTL2_6	CNTL2_5	CNTL2_4	CNTL2_3	CNTL2_2	CNTL2_1	CNTL2_0	00000000
Bit7	Bit6	Bit5	Bit4	Bit3	Bit2	Bit1	Bit0	
Address: 0x5A								

AUX_I2C_BIT2

Defines bits to toggle in the control register for auxiliary I²C device 2.

R/W	R/W	R/W	R/W	R/W	R/W	R/W	R/W	Reset Value
BIT2_7	BIT2_6	BIT2_5	BIT2_4	BIT2_3	BIT2_2	BIT2_1	BIT2_0	00000000
Bit7	Bit6	Bit5	Bit4	Bit3	Bit2	Bit1	Bit0	
Address: 0x5B								

AUX_I2C_ODR2_W

Defines register read controls for auxiliary I²C device 2.

R/W	R/W	R/W	R/W	R/W	R/W	R/W	R/W	Reset Value
Reserved	AUX2_D2	AUX2_D1	AUX2_D0	AUX2ODRW3	AUX2ODRW2	AUX2ODRW1	AUX2ODRW0	00000110
Bit7	Bit6	Bit5	Bit4	Bit3	Bit2	Bit1	Bit0	
Address: 0x5C								



Digital Tri-axis Gyroscope/ Tri-axis Accelerometer Specifications

PART NUMBER

KXG03-1034

Rev. 2.0

14-Feb-17

AUX2_D[2:0]: Number of bytes read back via Auxiliary I²C bus from device 2

[2]	[1]	[0]	No. of Bytes
0	0	0	0
0	0	1	1
0	1	0	2
0	1	1	3
1	0	0	4
1	0	1	5
1	1	0	6
1	1	1	DNE

AUX2ODRW[3:0]: Determines rate at which aux2 output is polled by KXG03 in aux2 wake state

[3]	[2]	[1]	[0]	Output Data Rate
0	0	0	0	0.781Hz
0	0	0	1	1.563Hz
0	0	1	0	3.125Hz
0	0	1	1	6.25Hz
0	1	0	0	12.5Hz
0	1	0	1	25Hz
0	1	1	0	50Hz
0	1	1	1	100Hz
1	0	0	0	200Hz
1	0	0	1	400Hz
1	0	1	0	800Hz
1	0	1	1	1600Hz
1	1	0	0	1600Hz
1	1	0	1	1600Hz
1	1	1	0	1600Hz
1	1	1	1	1600Hz

	Digital Tri-axis Gyroscope/ Tri-axis Accelerometer Specifications	PART NUMBER
		KXG03-1034
		Rev. 2.0
		14-Feb-17

AUX_I2C_ODR2_S

Defines register read controls for auxiliary I²C device 2.

R/W	R/W	R/W	R/W	R/W	R/W	R/W	R/W	Reset Value
Reserved	Reserved	Reserved	Reserved	AUX2ODRS3	AUX2ODRS2	AUX2ODRS1	AUX2ODRS0	00000110
Bit7	Bit6	Bit5	Bit4	Bit3	Bit2	Bit1	Bit0	
Address: 0x5D								

AUX2ODRS[3:0]: Determines rate at which aux2 output is polled by KXG03 in aux2 sleep state

[3]	[2]	[1]	[0]	Output Data Rate
0	0	0	0	0.781Hz
0	0	0	1	1.563Hz
0	0	1	0	3.125Hz
0	0	1	1	6.25Hz
0	1	0	0	12.5Hz
0	1	0	1	25Hz
0	1	1	0	50Hz
0	1	1	1	100Hz
1	0	0	0	200Hz
1	0	0	1	400Hz
1	0	1	0	800Hz
1	0	1	1	1600Hz
1	1	0	0	1600Hz
1	1	0	1	1600Hz
1	1	1	0	1600Hz
1	1	1	1	1600Hz

BUF_WMITH_L

Read/write control register that controls the buffer sample threshold.

R/W	R/W	R/W	R/W	R/W	R/W	R/W	R/W	Reset Value
SMP_TH1	SMP_TH0	Reserved	Reserved	Reserved	Reserved	Reserved	Reserved	00000000
Bit7	Bit6	Bit5	Bit4	Bit3	Bit2	Bit1	Bit0	
Address: 0x75								

	Digital Tri-axis Gyroscope/ Tri-axis Accelerometer Specifications	PART NUMBER
		KXG03-1034
		Rev. 2.0
		14-Feb-17

BUF_WMITH_H

Read/write control register that controls the buffer sample threshold.

R/W	R/W	R/W	R/W	R/W	R/W	R/W	R/W	
SMP_TH9	SMP_TH8	SMP_TH7	SMP_TH6	SMP_TH5	SMP_TH4	SMP_TH3	SMP_TH2	Reset Value
Bit7	Bit6	Bit5	Bit4	Bit3	Bit2	Bit1	Bit0	00000000
Address: 0x76								

SMP_TH[9:0] Sample Threshold; determines the number of data packets (ODR cycles) in a watermark interrupt in FIFO, Stream, FILO, or TRIGGER mode.

BUF_TRIGTH_L

Read/write control register that controls the buffer sample threshold.

R/W	R/W	R/W	R/W	R/W	R/W	R/W	R/W	
TRIG_TH1	TRIG_TH0	Reserved	Reserved	Reserved	Reserved	Reserved	Reserved	Reset Value
Bit7	Bit6	Bit5	Bit4	Bit3	Bit2	Bit1	Bit0	00000000
Address: 0x77								

BUF_TRIGTH_H

Read/write control register that controls the buffer sample threshold.

R/W	R/W	R/W	R/W	R/W	R/W	R/W	R/W	
TRIG_TH9	TRIG_TH8	TRIG_TH7	TRIG_TH6	TRIG_TH5	TRIG_TH4	TRIG_TH3	TRIG_TH2	Reset Value
Bit7	Bit6	Bit5	Bit4	Bit3	Bit2	Bit1	Bit0	00000000
Address: 0x78								

TRIG_TH[9:0] Trigger Threshold; determines the number of data packets (ODR cycles) that will trigger an interrupt in Trigger mode.



Digital Tri-axis Gyroscope/ Tri-axis Accelerometer Specifications

PART NUMBER

KXG03-1034

Rev. 2.0

14-Feb-17

BUF_CTL2

Read/write control register that controls sample buffer input in wake mode.

R/W	R/W	R/W	R/W	R/W	R/W	R/W	R/W	Reset Value
Reserved	BUF_TEMP_W	BUF_ACC_W_X	BUF_ACC_W_Y	BUF_ACC_W_Z	BUF_GYR_W_X	BUF_GYR_W_Y	BUF_GYR_W_Z	00000000
Bit7	Bit6	Bit5	Bit4	Bit3	Bit2	Bit1	Bit0	
Address: 0x79								

BUF_TEMP_W controls the Temperature input into the sample buffer.

BUF_TEMP_W = 0 – Temperature data is not input into the sample buffer

BUF_TEMP_W = 1 – Temperature data is input into the sample buffer

BUF_ACC_W[XYZ] controls the Accelerometer axis input into the sample buffer.

BUF_ACC_W = 0 – Accelerometer data is not input into the sample buffer

BUF_ACC_W = 1 – Accelerometer data is input into the sample buffer

BUF_GYR_W[XYZ] controls the Gyroscope axis input into the sample buffer.

BUF_GYR_W = 0 – Gyroscope data is not input into the sample buffer

BUF_GYR_W = 1 – Gyroscope data is input into the sample buffer

BUF_CTL3

Read/write control register that controls sample buffer input in sleep mode.

R/W	R/W	R/W	R/W	R/W	R/W	R/W	R/W	Reset Value
Reserved	BUF_TEMP_S	BUF_ACC_S_X	BUF_ACC_S_Y	BUF_ACC_S_Z	BUF_GYR_S_X	BUF_GYR_S_Y	BUF_GYR_S_Z	00000000
Bit7	Bit6	Bit5	Bit4	Bit3	Bit2	Bit1	Bit0	
Address: 0x7A								

BUF_TEMP_S controls the Temperature input into the sample buffer.

BUF_TEMP_S = 0 – Temperature data is not input into the sample buffer

BUF_TEMP_S = 1 – Temperature data is input into the sample buffer

BUF_ACC_S[XYZ] controls the Accelerometer axis input into the sample buffer.

BUF_ACC_S = 0 – Accelerometer data is not input into the sample buffer

BUF_ACC_S = 1 – Accelerometer data is input into the sample buffer

BUF_GYR_S[XYZ] controls the Gyroscope axis input into the sample buffer.

BUF_GYR_S = 0 – Gyroscope data is not input into the sample buffer

BUF_GYR_S = 1 – Gyroscope data is input into the sample buffer

	Digital Tri-axis Gyroscope/ Tri-axis Accelerometer Specifications	PART NUMBER
		KXG03-1034
		Rev. 2.0
		14-Feb-17

BUF_CTL4

Read/write control register that controls aux1 and aux2 buffer input.

R/W	R/W	R/W	R/W	R/W	R/W	R/W	R/W	Reset Value
Reserved	Reserved	Reserved	Reserved	BUF_AUX2_S	BUF_AUX1_S	BUF_AUX2_W	BUF_AUX1_W	00000000
Bit7	Bit6	Bit5	Bit4	Bit3	Bit2	Bit1	Bit0	
Address: 0x7B								

BUF_AUX2_S controls the aux2 input into the sample buffer in sleep mode.

BUF_AUX2_S = 0 – aux2 data is not input into the sample buffer

BUF_AUX2_S = 1 – aux2 data is input into the sample buffer

BUF_AUX1_S controls the aux1 axis input into the sample buffer in sleep mode.

BUF_AUX1_S = 0 – aux1 data is not input into the sample buffer

BUF_AUX1_S = 1 – aux1 data is input into the sample buffer

BUF_AUX2_W controls the aux2 input into the sample buffer in wake mode.

BUF_AUX2_W = 0 – aux2 data is not input into the sample buffer

BUF_AUX2_W = 1 – aux2 data is input into the sample buffer

BUF_AUX1_W controls the aux1 axis input into the sample buffer in wake mode.

BUF_AUX1_W = 0 – aux1 data is not input into the sample buffer

BUF_AUX1_W = 1 – aux1 data is input into the sample buffer

BUF_EN

Read/write control register that controls sample buffer operation.

R/W	R/W	R/W	R/W	R/W	R/W	R/W	R/W	Reset Value
BUFE	Reserved	Reserved	Reserved	BUF_SYM1	BUF_SYM0	BUF_M1	BUF_M0	00000000
Bit7	Bit6	Bit5	Bit4	Bit3	Bit2	Bit1	Bit0	
Address: 0x7C								

BUFE – controls activation of the sample buffer.

BUFE = 0 – sample buffer inactive

BUFE = 1 – sample buffer active

	Digital Tri-axis Gyroscope/ Tri-axis Accelerometer Specifications	PART NUMBER KXG03-1034 Rev. 2.0 14-Feb-17
---	--	--

BUF_SYM1, BUF_SYMO – Symbol mode select.

BUF_SYM1	BUF_SYMO	Description
0	0	Symbol mode disabled. KXG03 does not insert symbols into buffer output data stream.
0	1	Single symbol mode enabled. KXG03 inserts 0x8000 between complete data sets whenever wake/sleep mode changes. KXG03 replaces 0x8000 in gyroscope, accelerometer and die temp data with 0x8001 codes.
1	0	Dual symbol mode enables. KXG03 inserts x8000 between complete data sets to indicate wake-to-sleep transitions, and 0x8001 to indicate sleep-to-wake transitions. Symbols are only inserted when wake/sleep state changes. KXG03 replaces 0x8000 and 0x8001 gyroscope, accelerometer, and die temperature output data codes with 0x8002.
1	1	Dual symbol mode for every frame. KXG03 inserts 0x8000 or 0x8001 symbols between every complete data set (frame) according to the current wake/sleep state.

BUF_M1, BUF_M0 selects the operating mode of the sample buffer.

BUF_M1	BUF_M0	Mode	Description
0	0	FIFO*	The buffer collects up to 1024 bytes of data plus two (2) additional data sets until full, collecting new data only when the buffer is not full.
0	1	Stream	The buffer collects up to and holds the last 1024 bytes of data plus two (2) additional data sets. Once the buffer is full, the oldest data is discarded to make room for newer data.
1	0	Trigger*	When a trigger event occurs (logic high input on TRIG pin), the buffer holds the last data set of SMP[6:0] samples before the trigger event and then continues to collect data until full. New data is collected only when the buffer is not full.
1	1	FILO	The buffer holds the last 1024 bytes of data plus two (2) additional data sets. Once the buffer is full, the oldest data is discarded to make room for newer data. Reading from the buffer in this mode will return the most recent data first.

*Note: Data is stored as sets of bytes. If there is not enough room in the buffer to hold the new set of data (i.e. exceeds 1024-bytes + two (2) additional data sets), it will not be stored.



Digital Tri-axis Gyroscope/ Tri-axis Accelerometer Specifications

PART NUMBER

KXG03-1034

Rev. 2.0

14-Feb-17

BUF_STATUS

This register reports the status of the sample buffer trigger function.

R/W	R/W	R/W	R/W	R/W	R/W	R/W	R/W
BUF_TRIG	0	0	0	0	0	0	0
Bit7	Bit6	Bit5	Bit4	Bit3	Bit2	Bit1	Bit0
Address: 0x7D							

BUF_TRIG reports the status of the buffer's trigger function if this mode has been selected. When using trigger mode, a buffer read should only be performed after a trigger event.

BUF_CLEAR

Latched buffer status information and the entire sample buffer are cleared when any data is written to this register.

R/W	R/W	R/W	R/W	R/W	R/W	R/W	R/W
X	X	X	X	X	X	X	X
Bit7	Bit6	Bit5	Bit4	Bit3	Bit2	Bit1	Bit0
Address: 0x7E							

BUF_READ

Data from the buffer should be read using a single SAD+R command. The auto-increment feature of the buffer will continue to increment the read pointer to the next data in the buffer until the specified number of bytes is read. Output data is in 2's Complement format.

R	R	R	R	R	R	R	R
X	X	X	X	X	X	X	X
Bit7	Bit6	Bit5	Bit4	Bit3	Bit2	Bit1	Bit0
Address: 0x7F							

	Digital Tri-axis Gyroscope/ Tri-axis Accelerometer Specifications	PART NUMBER KXG03-1034 Rev. 2.0 14-Feb-17
---	--	---

Sample Buffer Feature Description

The 1024-byte sample buffer feature of the KXG03 accumulates and outputs data based on how it is configured. There are 4 buffer modes available. Data is collected at the highest ODR of the specified by the corresponding Wake and Sleep mode registers. Each buffer mode accumulates data, reports data, and interacts with status indicators in a slightly different way.

FIFO Mode

Data Accumulation

Sample collection stops when the buffer is full.

Data Reporting

Data is reported with the oldest byte of the oldest sample first (X_L or X based on resolution).

Status Indicators

A watermark interrupt occurs when the number of samples in the buffer reaches the Sample Threshold. The watermark interrupt stays active until the buffer contains less than this number of samples. This can be accomplished through clearing the buffer or reading greater than SMPX.

$$\text{SMPX} = \text{SMP_LEV}[9:0] - \text{SMP_TH}[9:0]$$

Equation 5: Samples above Sample Threshold

Stream Mode

Data Accumulation

Sample collection continues when the buffer is full; older data is discarded to make room for newer data.

Data Reporting

Data is reported with the oldest sample first (uses FIFO read pointer).

Status Indicators

A watermark interrupt occurs when the number of samples in the buffer reaches the Sample Threshold. The watermark interrupt stays active until the buffer contains less than this number of samples. This can be accomplished through clearing the buffer or explicitly reading greater than SMPX samples (calculated with Equation 5).

	Digital Tri-axis Gyroscope/ Tri-axis Accelerometer Specifications	PART NUMBER KXG03-1034 Rev. 2.0 14-Feb-17
---	--	---

Trigger Mode

Data Accumulation

When a logic high signal occurs on the TRIG pin, the trigger event is asserted and TRIG[9:0] samples prior to the event are retained. Sample collection continues until the buffer is full.

Data Reporting

Data is reported with the oldest sample first (uses FIFO read pointer).

Status Indicators

When a physical interrupt occurs and there are at least TRIG[9:0] samples in the buffer, BUF_TRIG in BUF_STATUS is asserted.

FILO Mode

Data Accumulation

Sample collection continues when the buffer is full; older data is discarded to make room for newer data.

Data Reporting

Data is reported with the newest byte of the newest sample first (Z_H or Z based on resolution).

Status Indicators

A watermark interrupt occurs when the number of samples in the buffer reaches the Sample Threshold. The watermark interrupt stays active until the buffer contains less than this number of samples. This can be accomplished through clearing the buffer or explicitly reading greater than SMPX samples (calculated with Equation 5).

Buffer Operation

The following diagrams illustrate the operation of the buffer conceptually. Actual physical implementation has been abstracted to offer a simplified explanation of how the different buffer modes operate. Figure 7 represents a high-resolution 3-axis sample within the buffer. Figure 8 through Figure 16 represent a 10-sample version of the buffer (for simplicity), with Sample Threshold set to 8.

Regardless of the selected mode, the buffer fills sequentially, one byte at a time. Figure 7 shows one 6-byte data sample. Note the location of the FILO read pointer versus that of the FIFO read pointer.



Digital Tri-axis Gyroscope/ Tri-axis Accelerometer Specifications

PART NUMBER

KXG03-1034

Rev. 2.0

14-Feb-17

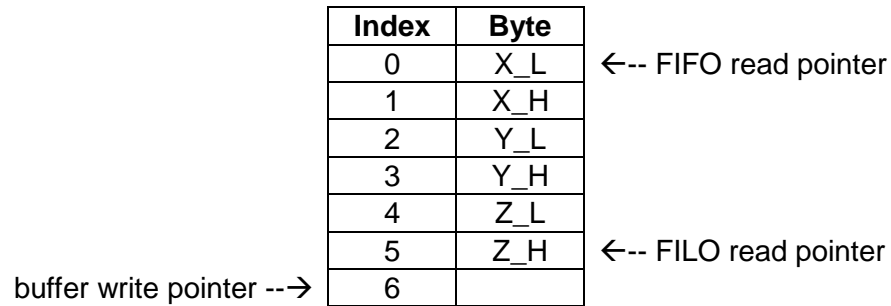

Figure 7: One Buffer Sample

Regardless of the selected mode, the buffer fills sequentially, one sample at a time. Note in Figure 8 the location of the FILO read pointer versus that of the FIFO read pointer. The buffer write pointer shows where the next sample will be written to the buffer.

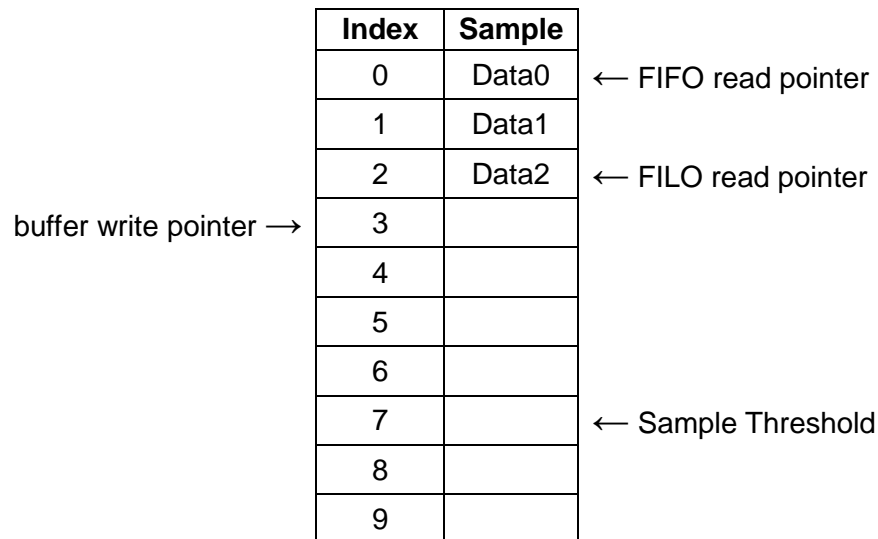

Figure 8: Buffer Filling



Digital Tri-axis Gyroscope/ Tri-axis Accelerometer Specifications

PART NUMBER
KXG03-1034
Rev. 2.0
14-Feb-17

The buffer continues to fill sequentially until the Sample Threshold is reached. Note in Figure 9 the location of the FILO read pointer versus that of the FIFO read pointer.

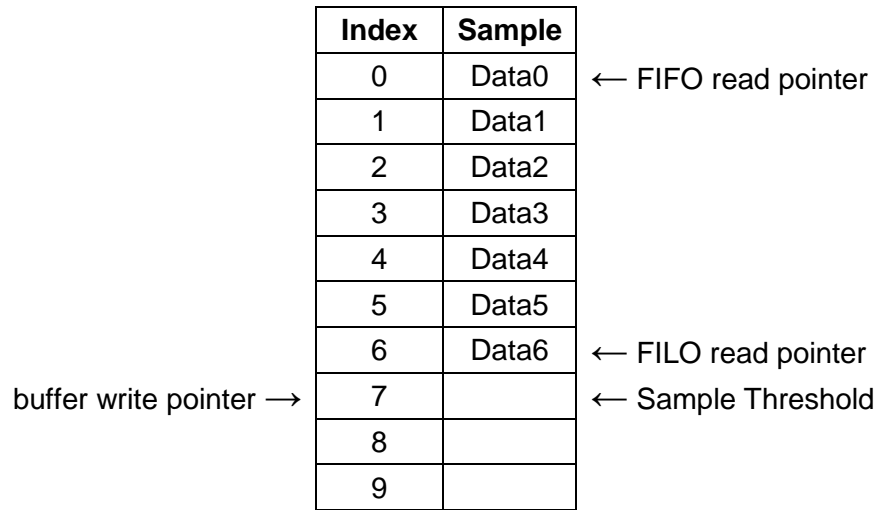

Figure 9: Buffer Approaching Sample Threshold

In FIFO, Stream, and FILO modes, a watermark interrupt is issued when the number of samples in the buffer reaches the Sample Threshold. In trigger mode, this is the point where the oldest data in the buffer is discarded to make room for newer data.

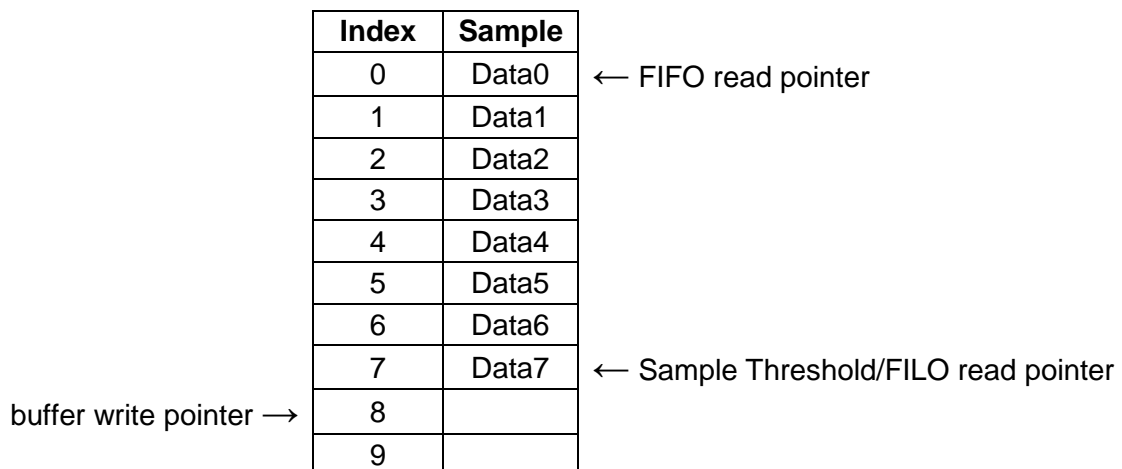

Figure 10: Buffer at Sample Threshold

In trigger mode, data is accumulated in the buffer sequentially until the Trigger Threshold is reached. Once the Trigger Threshold is reached, the oldest samples are discarded when new samples are collected. Note in Figure 11 how Data0 was thrown out to make room for Data8.

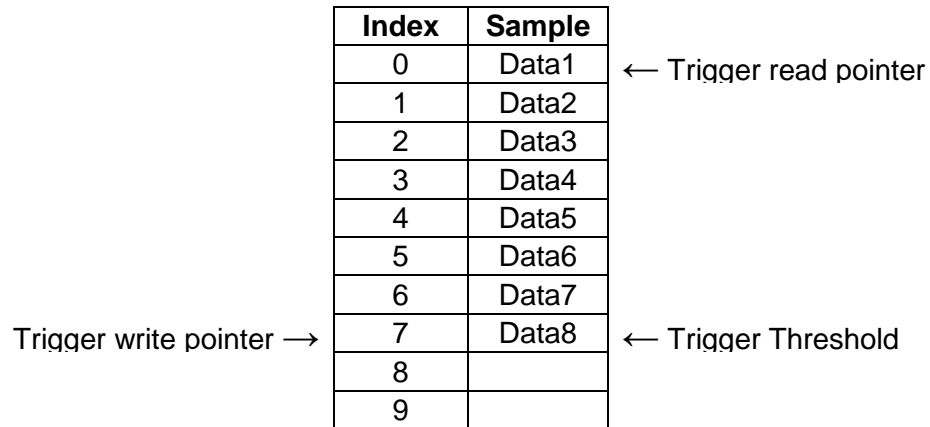

Figure 11: Additional Data Prior to Trigger Event

After a trigger event occurs, the buffer no longer discards the oldest samples, and instead begins accumulating samples sequentially until full. The buffer then stops collecting samples, as seen in Figure 12. This results in the buffer holding TRIG_TH[9:0] samples prior to the trigger event, and TRIGX samples after the trigger event.

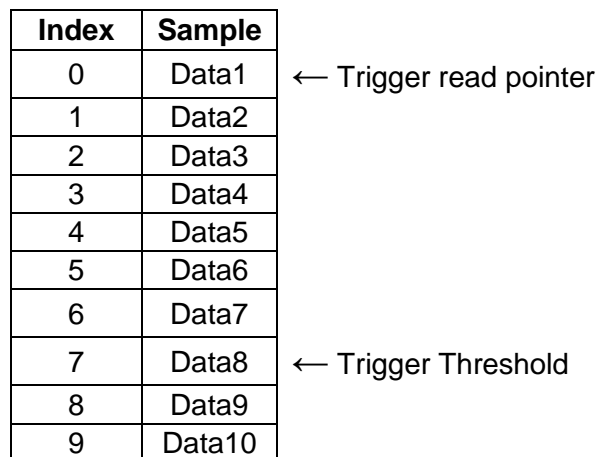



Figure 12: Additional Data after Trigger Event

	Digital Tri-axis Gyroscope/ Tri-axis Accelerometer Specifications	PART NUMBER KXG03-1034 Rev. 2.0 14-Feb-17
---	--	--

In FIFO, Stream, FILO, and Trigger (after a trigger event has occurred) modes, the buffer continues filling sequentially after the Sample Threshold is reached. Sample accumulation after the buffer is full depends on the selected operation mode. FIFO and Trigger modes stop accumulating samples when the buffer is full, and Stream and FILO modes begin discarding the oldest data when new samples are accumulated.

Index	Sample	
0	Data0	← FIFO read pointer
1	Data1	
2	Data2	
3	Data3	
4	Data4	
5	Data5	
6	Data6	
7	Data7	← Sample Threshold
8	Data8	
9	Data9	← FILO read pointer

Figure 13: Buffer Full

After the buffer has been filled in FILO or Stream mode, the oldest samples are discarded when new samples are collected. Note in Figure 14 how Data0 was thrown out to make room for Data10.

Index	Sample	
0	Data1	← FIFO read pointer
1	Data2	
2	Data3	
3	Data4	
4	Data5	
5	Data6	
6	Data7	
7	Data8	← Sample Threshold
8	Data9	
9	Data10	← FILO read pointer

Figure 14: Buffer Full – Additional Sample Accumulation in Stream or FILO Mode



Digital Tri-axis Gyroscope/ Tri-axis Accelerometer Specifications

PART NUMBER

KXG03-1034

Rev. 2.0

14-Feb-17

In FIFO, Stream, or Trigger mode, reading one sample from the buffer will remove the oldest sample and effectively shift the entire buffer contents up, as seen in Figure 15.

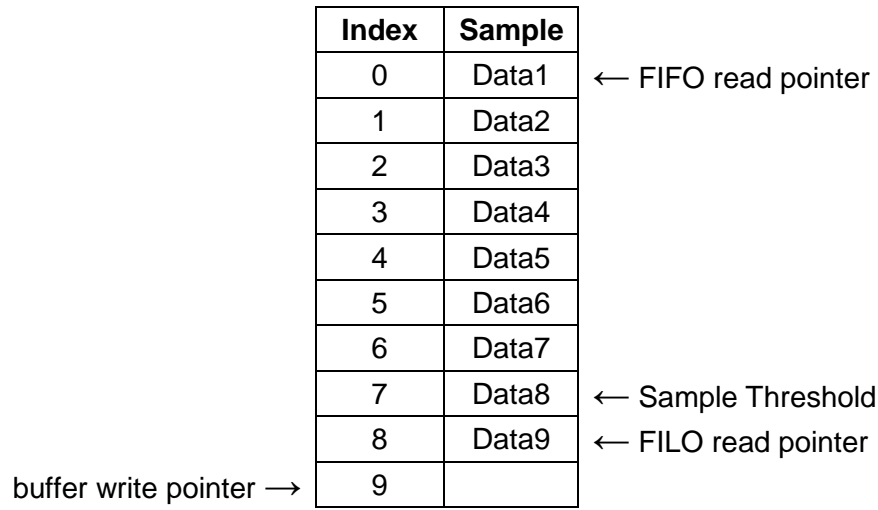

Figure 15: FIFO Read from Full Buffer

In FILO mode, reading one sample from the buffer will remove the newest sample and leave the older samples untouched, as seen in Figure 16.

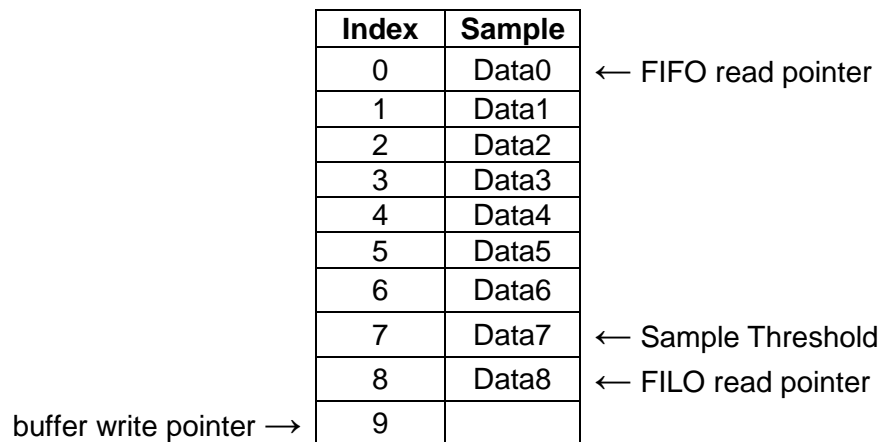



Figure 16: FILO Read from Full Buffer

	Digital Tri-axis Gyroscope/ Tri-axis Accelerometer Specifications	PART NUMBER KXG03-1034 Rev. 2.0 14-Feb-17
---	--	--

Synchronizing Buffer Updates to External Clock

The buffer can be configured to update in sync with an external clock applied at the SYNC pin. Setting `FSYNC_MODE=2'b01` enables the external buffer sync feature. This forces the data in the buffer to be updated at the positive edge of the SYNC pin only. Please note even with `FSYNC_MODE=2'b01` the respective sensor output registers still update at the sensors' output data rates (ODR).

External Interrupt Sampling

The buffer can be configured to store the state of the SYNC pin in the buffer. Setting `FSYNC_MODE=2'b10` forces the KXG03 to replace the LSB bit of the selected sensor axis with the state of SYNC pin at the time of the buffer update. This allows the user to sample the state of an external interrupt and store the interrupt value in the buffer. Please note: This function only impacts the data stored in the buffer. The sensor output registers are not impacted by this function.

Input Data Select

The user can select which sensor's data is added to the buffer. It is possible to operate with a sensor enabled, but none of its data being stored in the buffer. In addition, for the accelerometer and gyroscope, the user can also select which axes' data is added to the buffer. There is no capability to select which auxiliary axis is added to the buffer. If auxiliary data is selected all of the corresponding sensor's data that is being read is added to the buffer.

Care needs to be taken to handle cases where a sensor's output is selected for the buffer, but the sensor is not enabled. In this case, the last available output for the selected sensor's is added to the buffer. If the output is not available, zeros (0's) are placed in the buffer to that sensor's output.

Data Order

Assuming all sensors are selected to send data to the buffer, new The data in the buffer is in the following order: gyro-x, gyro-y, gyro-z, accel-x, accel-y, accel-z, temperature, aux1, aux2. In case a sensor's output data is not selected for the buffer that sensor's slot would be skipped. Example: Assume only gyro-y, aux2 and temperature are selected for the buffer, the buffer data would then be in the following order: gyro-y, temperature, aux2.

	Digital Tri-axis Gyroscope/ Tri-axis Accelerometer Specifications	PART NUMBER KXG03-1034 Rev. 2.0 14-Feb-17
---	--	---

Buffer Update Rate

New data is added to the buffer at the highest configured ODR rate of all the enabled sensors (STDBY). Data is added for all selected sensors (BUF_CTL2, BUF_CTL3, BUF_CTL4). In the case where a selected sensor does not have new data available, it is repeated from the previous time point.

Consider the following example: Both accelerometer and gyroscope are selected to add data to the buffer and are enabled to output (STDBY). The accelerometer operates at ODR=400 Hz and the gyroscope operates at ODR=100 Hz. New data accumulates into the buffer at a 400 Hz rate. The accelerometer data is updated at the 400 Hz rate while the gyroscope data remains constant for 3 out of 4 samples.

```
gyro_d0, accel_d0
gyro_d0, accel_d1
gyro_d0, accel_d2
gyro_d0, accel_d3
gyro_d1, accel_d4
gyro_d1, accel_d5
gyro_d1, accel_d6
gyro_d1, accel_d7
gyro_d2, accel_d8
...
```

Buffer Size Description

The buffer has a maximum size is 1024 bytes plus an additional two (2) buffers, thus expanding the overall buffer size in bytes by two (2) times the dataset in bytes ($2 * dataset_in_bytes$).

The dataset in bytes (*dataset_in_bytes*) depends on what is actively being stored into the buffer. This includes which sensors are configured to store into the buffer (gyroscope, accelerometer, temperature, auxillary1, and/or auxillary2), as well as, selected axis (gyroscope and accelerometer only). The temperature sensor stores 2 bytes at a time. The data for gyroscope, accelerometer, auxillary1, and auxillary2 sensors is 6 bytes in length each. For gyroscope and accelerometer only, each axis can store 2 bytes each (if selected).

	Digital Tri-axis Gyroscope/ Tri-axis Accelerometer Specifications	PART NUMBER KXG03-1034 Rev. 2.0 14-Feb-17
---	--	--

$$\text{Maximum \# Bytes} = 1024 + 2 * (\text{gyro_dataset_in_bytes} + \text{accel_dataset_in_bytes} + \text{aux1_dataset_in_bytes} + \text{aux2_dataset_in_bytes} + \text{temp_dataset_in_bytes})$$

$$\text{Maximum \# Bytes} = 1024 + 2 (26)$$

Equation 6: Maximum Number of Bytes

Example: If accelerometer (x) and gyroscope (x, y, z) are selected to be stored in the buffer, then the *dataset_in_bytes* is equal 8 bytes (1*2 + 3*6). Maximum number of bytes = 1024 + (2*8) = 1040.

Note: To ensure the buffer is large enough, ideally declare a buffer size equal the maximum number of bytes when all sensors and axis are selected to be stored. With all sensors enabled and selected each data set contains 26 bytes (3 gyroscope axes at 2 bytes each, 3 accelerometer axes at 2 bytes each, 2 bytes for temperature, plus 6 bytes for each of the two auxiliary sensors).

The maximum number of ODR cycles the buffer can actually hold is determined by dividing the maximum buffer size (1024 bytes) by the dataset in bytes and adding two (2) samples.

$$\text{Maximum \# ODR Cycles} = \text{round-down}(1024/\text{dataset_in_bytes}) + 2$$

Equation 7: Maximum Number of ODR Cycles

The number of bytes to read from the sample buffer is determined by multiplying the number of samples (BUF_SMPLEV) by the *dataset_in_bytes*. If only accelerometer (x, y and z) data is being stored to the buffer, the number of bytes to read when the buffer is full would be equal to 4104 (684 ODR cycles * 6 bytes).

Buffer Full Interrupt (BFI)

The buffer features a buffer full interrupt. When enabled, the buffer full interrupt triggers when the buffer contains so much un-read data that the buffer has insufficient space for one

	Digital Tri-axis Gyroscope/ Tri-axis Accelerometer Specifications	PART NUMBER KXG03-1034 Rev. 2.0 14-Feb-17
---	--	--

additional full data set. This implies that the buffer full level is a function of which (or how much) data is selected to go into the buffer.

With all sensors enabled and selected each data set contains 26 bytes (3 accel axes at 2 bytes each, 3 gyro axes at 2 bytes each, 2 bytes for temperature, plus 6 bytes for each of the two aux sensors). In this case buffer full would be triggered when the buffer contains less than 26 bytes of free space, or when the remaining buffer space is smaller than the size of the data set.

The max size of one data set is 26 bytes as mentioned above. The minimum data packet size is 1 byte. In cases (assuming an auxiliary sensor is active in single byte mode and only the auxiliary data is stored in the buffer) in which case the buffer can hold up to 2048 data sets since the data is stored in 17-bit words.

The buffer generates a buffer full output flag, BFI, for the interrupt control logic while BUF_EN=1. The buffer shall not generate a BFI flag while BUF_EN=0. Latching and clearing of the BFI is handled in the interrupt control logic module.

SMP_PAST Counter (Packets Lost Since BFI)

SMP_PAST[9:0] measures the number of data-sets or packets lost since buffer full status was reached. For FIFO and TRIGGER modes this is equal to the number of ODR cycles since the buffer full level has been reached. For STREAM mode this is equal to the number of data-sets that have been overridden by new data since the buffer filled up. The SMP_PAST counter stops counting when the buffer output is read. SMP_PAST[9:0] is cleared when the SMP_PAST is read or the buffer is cleared. Care needs to be taken not to overflow SMP_PAST[9:0].

Watermark (WMI)

The buffer includes a programmable watermark. The watermark (SMP_TH[9:0]) is measured in number of data sets in the buffer. In other words, the watermark is measured at the highest ODR rate of all the sensors selected to write in to the buffer.

The buffer generates a watermark output flag, WMI, for the interrupt control logic while BUF_EN=1. The buffer shall not generate a WMI flag while BUF_EN=0. Latching and clearing of the wmi is handled in the interrupt control logic module.

Buffer Level

SMP_LEV[9:0] indicates to the user how many data sets (ODR cycles) are currently stored in the buffer. Please note when operating the buffer in STREAM mode or during the STREAM

	Digital Tri-axis Gyroscope/ Tri-axis Accelerometer Specifications	PART NUMBER KXG03-1034 Rev. 2.0 14-Feb-17
---	--	--

phase of TRIGGER mode SMP_LEV will briefly decrement by one count during a buffer full condition while the buffer discard old data for new incoming data.

Changing Buffer Configurations

Unless otherwise noted, buffer configurations can only be changed while the buffer is disabled (BUF_EN=0). This includes data select bits, buffer operating mode, watermark level, etc.

Changing Sensor Configurations

Changes to the sensor configuration (ODR, Bandwidth, FS range, etc.) while the buffer is enabled are not captured in the buffer. It is strongly recommended to disable and flush the buffer when changing sensor configurations.

Clearing the Buffer

The buffer is cleared or flushed and all counters are reset when (1) a non-zero value to the BUF_CLEAR register or (2) the buffer transitions from disabled (BUF_EN=0) to (BUF_EN=1) state. Clearing the buffer takes approximately 2-3 μ sec. To avoid receiving corrupted data, the buffer contents, sample level, or packets lost for the first 10 μ sec after clearing or enabling the buffer.

Buffer Reads

The buffer is read from register 0x7F (BUF_READ). The buffer data shall be read using burst mode read operations (See Digital Interface section for more details). The buffer holds off writing to RAM during buffer reads of registers 0x7C-0x7F to avoid loss of data occurring during read/write collisions. The held off data is written to the RAM at the end of the burst mode read operation. This is done for all buffer modes. This requires to end the burst mode read operations within $\frac{1}{2}$ of the ODR cycle to avoid loss of new data. For multiple sensor scenarios, “within $\frac{1}{2}$ ODR cycle” becomes “within half the period of the highest enabled ODR cycle”. The time required to read out N number of datasets is a function of the SPI/I2C clock rate, the selected ODR and the selected dataset size. Exercise care when configuration the KXG08 to avoid loss of data during buffer reads.

Important Note: Single byte reads are supported. However, it is required to read out each 16-bit word (2 bytes) in less than 1 ODR cycle. Stretching out the read of a data byte to more than one ODR cycle will lead to data corruption.

	Digital Tri-axis Gyroscope/ Tri-axis Accelerometer Specifications	PART NUMBER KXG03-1034 Rev. 2.0 14-Feb-17
---	--	--

Revision History

REVISION	DESCRIPTION	DATE
1.0	Initial release	22-Jun-2016
2.0	Swapped order of GYRO_RUN and GYRO_START in the bit description section for STATUS1 register (0x36). Changed name for AUX_I2C_CTRL_REG to AUX_I2C_CTL_REG Changed the note regarding AUX_PULL_UP in AUX_I2C_CTL_REG Changed the reset value of AUX_I2C_CTRL_REG to 0x02 (aux_bypass=1) Added additional note to pin descriptions regarding applications not utilizing AUX_CL, AUX_DA, and updated nCS bit description. Updated VDD max, Power Consumption, Noise values, and Software Reset value. Increased temperature sensor tolerance to 3°C in table 3. Cleared up some buffer description in regards to how fast samples are collect if running different ODRs. Added buffer update rate section. Updated name of BUF_SMPLEV bits to SMP_LEV, BUF_SMPPAST to SMP_PAST Removed BUF_RES from Equation 5 description since this option doesn't exist. Fixed High Byte bit numbering in ACCELEROMETER_XOUT, YOUT, and ZOUT Deleted Notice Added Appendix Moved POR to Technical Note Buffer size clarification in buffer registers Buffer Description section updated Changed RST bit in CNTL_REG1 to SRST Updated I2C Serial Interface section	14-Feb-2017

"Kionix" is a registered trademark of Kionix, Inc. Products described herein are protected by patents issued or pending. No license is granted by implication or otherwise under any patent or other rights of Kionix. The information contained herein is believed to be accurate and reliable but is not guaranteed. Kionix does not assume responsibility for its use or distribution. Kionix also reserves the right to change product specifications or discontinue this product at any time without prior notice. This publication supersedes and replaces all information previously supplied.

Appendix

The following Notice is included to guide the use of Kionix products in its application and manufacturing processes. Kionix, Inc., is a ROHM Group company. For purposes of this Notice, the name "ROHM" would also imply Kionix, Inc.

Notice

Precaution on using ROHM Products

- Our Products are designed and manufactured for application in ordinary electronic equipments (such as AV equipment, OA equipment, telecommunication equipment, home electronic appliances, amusement equipment, etc.). If you intend to use our Products in devices requiring extremely high reliability (such as medical equipment ^(Note 1), transport equipment, traffic equipment, aircraft/spacecraft, nuclear power controllers, fuel controllers, car equipment including car accessories, safety devices, etc.) and whose malfunction or failure may cause loss of human life, bodily injury or serious damage to property ("Specific Applications"), please consult with the ROHM sales representative in advance. Unless otherwise agreed in writing by ROHM in advance, ROHM shall not be in any way responsible or liable for any damages, expenses or losses incurred by you or third parties arising from the use of any ROHM's Products for Specific Applications.

(Note1) Medical Equipment Classification of the Specific Applications

JAPAN	USA	EU	CHINA
CLASS III	CLASS III	CLASS II b	CLASS III
CLASS IV		CLASS III	

- ROHM designs and manufactures its Products subject to strict quality control system. However, semiconductor products can fail or malfunction at a certain rate. Please be sure to implement, at your own responsibilities, adequate safety measures including but not limited to fail-safe design against the physical injury, damage to any property, which a failure or malfunction of our Products may cause. The following are examples of safety measures:
 - Installation of protection circuits or other protective devices to improve system safety
 - Installation of redundant circuits to reduce the impact of single or multiple circuit failure
- Our Products are designed and manufactured for use under standard conditions and not under any special or extraordinary environments or conditions, as exemplified below. Accordingly, ROHM shall not be in any way responsible or liable for any damages, expenses or losses arising from the use of any ROHM's Products under any special or extraordinary environments or conditions. If you intend to use our Products under any special or extraordinary environments or conditions (as exemplified below), your independent verification and confirmation of product performance, reliability, etc. prior to use, must be necessary:
 - Use of our Products in any types of liquid, including water, oils, chemicals, and organic solvents
 - Use of our Products outdoors or in places where the Products are exposed to direct sunlight or dust
 - Use of our Products in places where the Products are exposed to sea wind or corrosive gases, including Cl₂, H₂S, NH₃, SO₂, and NO₂
 - Use of our Products in places where the Products are exposed to static electricity or electromagnetic waves
 - Use of our Products in proximity to heat-producing components, plastic cords, or other flammable items
 - Sealing or coating our Products with resin or other coating materials
 - Use of our Products without cleaning residue of flux (even if you use no-clean type fluxes, cleaning residue of flux is recommended); or Washing our Products by using water or water-soluble cleaning agents for cleaning residue after soldering
 - Use of the Products in places subject to dew condensation
- The Products are not subject to radiation-proof design.
- Please verify and confirm characteristics of the final or mounted products in using the Products.
- In particular, if a transient load (a large amount of load applied in a short period of time, such as pulse. is applied, confirmation of performance characteristics after on-board mounting is strongly recommended. Avoid applying power exceeding normal rated power; exceeding the power rating under steady-state loading condition may negatively affect product performance and reliability.
- De-rate Power Dissipation depending on ambient temperature. When used in sealed area, confirm that it is the use in the range that does not exceed the maximum junction temperature.
- Confirm that operation temperature is within the specified range described in the product specification.
- ROHM shall not be in any way responsible or liable for failure induced under deviant condition from what is defined in this document.

Precaution for Mounting / Circuit board design

- When a highly active halogenous (chlorine, bromine, etc.) flux is used, the residue of flux may negatively affect product performance and reliability.
- In principle, the reflow soldering method must be used on a surface-mount products, the flow soldering method must be used on a through hole mount products. If the flow soldering method is preferred on a surface-mount products, please consult with the ROHM representative in advance.

For details, please refer to ROHM Mounting specification

Precautions Regarding Application Examples and External Circuits

1. If change is made to the constant of an external circuit, please allow a sufficient margin considering variations of the characteristics of the Products and external components, including transient characteristics, as well as static characteristics.
2. You agree that application notes, reference designs, and associated data and information contained in this document are presented only as guidance for Products use. Therefore, in case you use such information, you are solely responsible for it and you must exercise your own independent verification and judgment in the use of such information contained in this document. ROHM shall not be in any way responsible or liable for any damages, expenses or losses incurred by you or third parties arising from the use of such information.

Precaution for Electrostatic

This Product is electrostatic sensitive product, which may be damaged due to electrostatic discharge. Please take proper caution in your manufacturing process and storage so that voltage exceeding the Products maximum rating will not be applied to Products. Please take special care under dry condition (e.g. Grounding of human body / equipment / solder iron, isolation from charged objects, setting of Ionizer, friction prevention and temperature / humidity control).

Precaution for Storage / Transportation

1. Product performance and soldered connections may deteriorate if the Products are stored in the places where:
 - [a] the Products are exposed to sea winds or corrosive gases, including Cl₂, H₂S, NH₃, SO₂, and NO₂
 - [b] the temperature or humidity exceeds those recommended by ROHM
 - [c] the Products are exposed to direct sunshine or condensation
 - [d] the Products are exposed to high Electrostatic
2. Even under ROHM recommended storage condition, solderability of products out of recommended storage time period may be degraded. It is strongly recommended to confirm solderability before using Products of which storage time is exceeding the recommended storage time period.
3. Store / transport cartons in the correct direction, which is indicated on a carton with a symbol. Otherwise bent leads may occur due to excessive stress applied when dropping of a carton.
4. Use Products within the specified time after opening a humidity barrier bag. Baking is required before using Products of which storage time is exceeding the recommended storage time period.

Precaution for Product Label

A two-dimensional barcode printed on ROHM Products label is for ROHM's internal use only.

Precaution for Disposition

When disposing Products please dispose them properly using an authorized industry waste company.

Precaution for Foreign Exchange and Foreign Trade act

Since concerned goods might be fallen under listed items of export control prescribed by Foreign exchange and Foreign trade act, please consult with ROHM in case of export.

Precaution Regarding Intellectual Property Rights

1. All information and data including but not limited to application example contained in this document is for reference only. ROHM does not warrant that foregoing information or data will not infringe any intellectual property rights or any other rights of any third party regarding such information or data.
2. ROHM shall not have any obligations where the claims, actions or demands arising from the combination of the Products with other articles such as components, circuits, systems or external equipment (including software).
3. No license, expressly or implied, is granted hereby under any intellectual property rights or other rights of ROHM or any third parties with respect to the Products or the information contained in this document. Provided, however, that ROHM will not assert its intellectual property rights or other rights against you or your customers to the extent necessary to manufacture or sell products containing the Products, subject to the terms and conditions herein.

Other Precaution

1. This document may not be reprinted or reproduced, in whole or in part, without prior written consent of ROHM.
2. The Products may not be disassembled, converted, modified, reproduced or otherwise changed without prior written consent of ROHM.
3. In no event shall you use in any way whatsoever the Products and the related technical information contained in the Products or this document for any military purposes, including but not limited to, the development of mass-destruction weapons.
4. The proper names of companies or products described in this document are trademarks or registered trademarks of ROHM, its affiliated companies or third parties.