

RoHS Compliant & Pb-Free Product
Package Style: Micro-X Ceramic

Features

- DC to 6000MHz Operation
- Internally matched Input and Output
- 16dB Small Signal Gain
- +26dBm Output IP3
- +12dBm Output Power
- Excellent Gain Flatness

Applications

- Broadband, Low Noise Gain Blocks
- IF or RF Buffer Amplifiers
- Driver Stage for Power Amplifiers
- Final PA for Low Power Applications
- High Reliability Applications
- Broadband Test Equipment

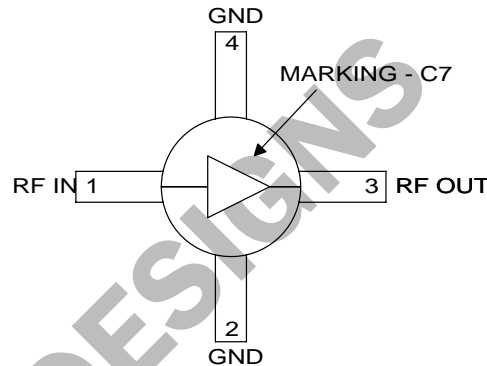

Functional Block Diagram

Product Description

The RF2047 is a general purpose, low cost RF amplifier IC. The device is manufactured on an advanced Gallium Arsenide Heterojunction Bipolar Transistor (HBT) process, and has been designed for use as an easily-cascadable 50Ω gain block. Applications include IF and RF amplification in wireless voice and data communication products operating in frequency bands up to 6000MHz. The device is self-contained with 50Ω input and output impedances and requires only two external DC biasing elements to operate as specified. With a goal of enhanced reliability, the extremely small Micro-X ceramic package offers significantly lower thermal resistance than similar size plastic packages.

Ordering Information

RF2047	General Purpose Amplifier
RF2047PCBA-41X	Fully Assembled Evaluation Board

Optimum Technology Matching® Applied

- | | | | |
|--|--------------------------------------|-------------------------------------|-----------------------------------|
| <input checked="" type="checkbox"/> GaAs HBT | <input type="checkbox"/> SiGe BiCMOS | <input type="checkbox"/> GaAs pHEMT | <input type="checkbox"/> GaN HEMT |
| <input type="checkbox"/> GaAs MESFET | <input type="checkbox"/> Si BiCMOS | <input type="checkbox"/> Si CMOS | |
| <input type="checkbox"/> InGaP HBT | <input type="checkbox"/> SiGe HBT | <input type="checkbox"/> Si BJT | |

RF MICRO DEVICES®, RFMD®, Optimum Technology Matching®, Enabling Wireless Connectivity™, PowerStar®, POLARIS™ TOTAL RADIO™ and UltimateBlue™ are trademarks of RFMD, LLC. BLUETOOTH is a trademark owned by Bluetooth SIG, Inc., U.S.A. and licensed for use by RFMD. All other trade names, trademarks and registered trademarks are the property of their respective owners. ©2006, RF Micro Devices, Inc.

Absolute Maximum Ratings

Parameter	Rating	Unit
Input RF Power	+13	dBm
Operating Ambient Temperature	-40 to +85	°C
Storage Temperature	-60 to +150	°C



Caution! ESD sensitive device.

The information in this publication is believed to be accurate and reliable. However, no responsibility is assumed by RF Micro Devices, Inc. ("RFMD") for its use, nor for any infringement of patents, or other rights of third parties, resulting from its use. No license is granted by implication or otherwise under any patent or patent rights of RFMD. RFMD reserves the right to change component circuitry, recommended application circuitry and specifications at any time without prior notice.

RoHS status based on EUDirective2002/95/EC (at time of this document revision).

Parameter	Specification			Unit	Condition
	Min.	Typ.	Max.		
Overall					T=25 °C, V _D =3.6V, I _{CC} =40mA
Frequency Range		DC to 6000		MHz	
3dB Bandwidth		>6		GHz	
Gain		16.0		dB	Freq=100MHz
		15.9		dB	Freq=1000MHz
	14.0	15.8		dB	Freq=2000MHz
		15.2		dB	Freq=3000MHz
		14.5		dB	Freq=4000MHz
		13.5		dB	Freq=6000MHz
Gain Flatness		±0.1		dB	100MHz to 2000MHz
Noise Figure		3.6		dB	Freq=2000MHz
Input VSWR		<1.6:1			In a 50Ω system, DC to 3000MHz
		<1.2:1			In a 50Ω system, 3000MHz to 6000MHz
Output VSWR		<1.5:1			In a 50Ω system, DC to 3000MHz
		<1.5:1			In a 50Ω system, 3000MHz to 6000MHz
Output IP ₃		+26		dBm	Freq=2000MHz±50kHz, P _{TONE} =-10dBm
Output P _{1dB}		+12.2		dBm	Freq=2000MHz
Reverse Isolation		18.7		dB	Freq=2000MHz
Thermal					I _{CC} =40mA, P _{DISS} =135mW (See Note 1.)
Theta _{JC}		332		°C/W	V _{PIN} =3.37V
Maximum Measured Junction Temperature at DC Bias Conditions		130		°C	
Mean Time To Failure		65,000		years	T _{AMB} =+85 °C
Power Supply					With 22Ω bias resistor, T=+25 °C
Device Operating Voltage	3.0	3.6	4.0	V	At pin 3 with I _{CC} =40mA
	3.9	4.5	4.9	V	At evaluation board connector, I _{CC} =40mA
Operating Current			40	mA	See Note 2.

NOTES:

Note 1: The RF2047 must be operated at or below 40mA in order to achieve the thermal performance stated above. Operating at 40mA will ensure the best possible combination of reliability and electrical performance.

Note 2: Because of process variations from part to part, the current resulting from a fixed bias voltage will vary. As a result, caution should be used in designing fixed voltage bias circuits to ensure the worst case bias current does not exceed 40mA over all intended operating conditions.

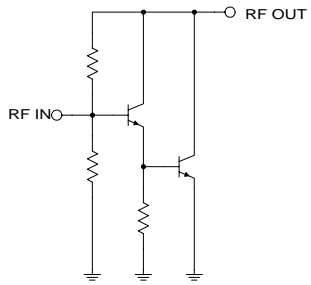
Pin	Function	Description	Interface Schematic
1	RF IN	RF input pin. This pin is NOT internally DC-blocked. A DC-blocking capacitor, suitable for the frequency of operation, should be used in most applications. DC-coupling of the input is not allowed, because this will override the internal feedback loop and cause temperature instability.	
2	GND	Ground connection. For best performance, keep traces physically short and connect immediately to ground plane.	
3	RF OUT	RF output and bias pin. Biasing is accomplished with an external series resistor and choke inductor to V _{CC} . The resistor is selected to set the DC current into this pin to a desired level. The resistor value is determined by the following equation: $R = \frac{(V_{SUPPLY} - V_{DEVICE})}{I_{CC}}$ <p>Care should also be taken in the resistor selection to ensure that the current into the part never exceeds 40mA over the planned operating temperature. This means that a resistor between the supply and this pin is always required, even if a supply near 3.6V is available, to provide DC feedback to prevent thermal runaway. Because DC is present on this pin, a DC-blocking capacitor, suitable for the frequency of operation, should be used in most applications. The supply side of the bias network should also be well bypassed.</p>	
4	GND	Same as pin 2.	

Package Drawing

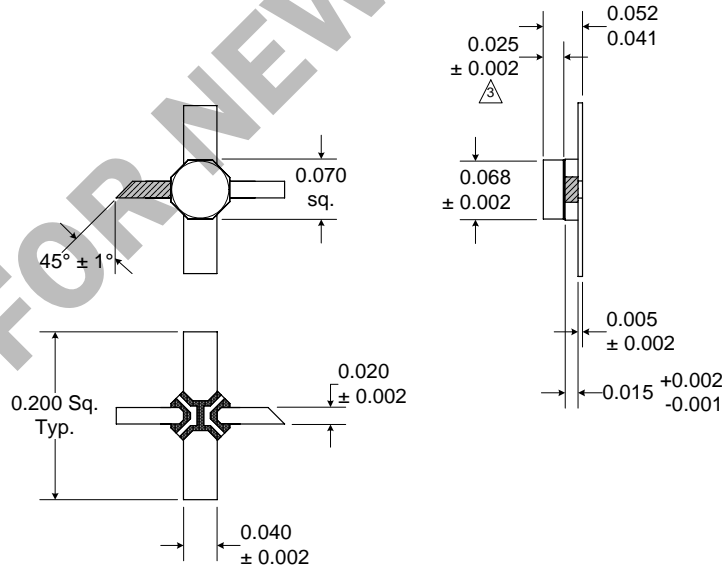

NOTES:

1. Shaded lead is pin 1.
2. Darkened areas are metallization.
3. Dimension applies to ceramic lid minus epoxy coating.

Application Schematic

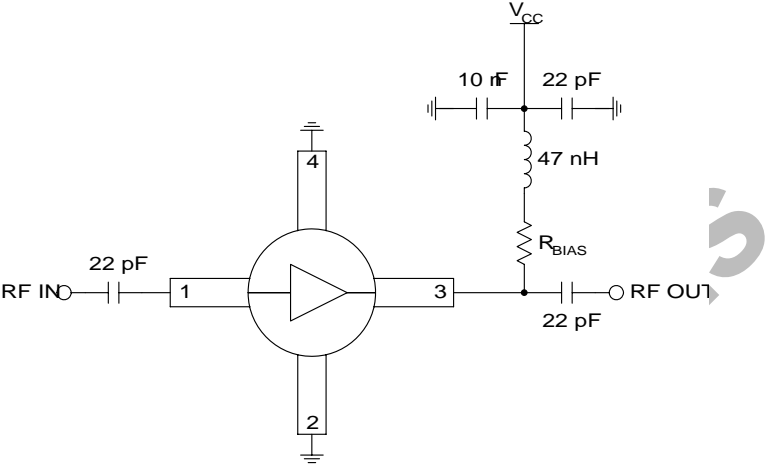

NOT FOR NEW DESIGN

Evaluation Board Schematic

(Download [Bill of Materials](http://www.rfmd.com) from www.rfmd.com.)

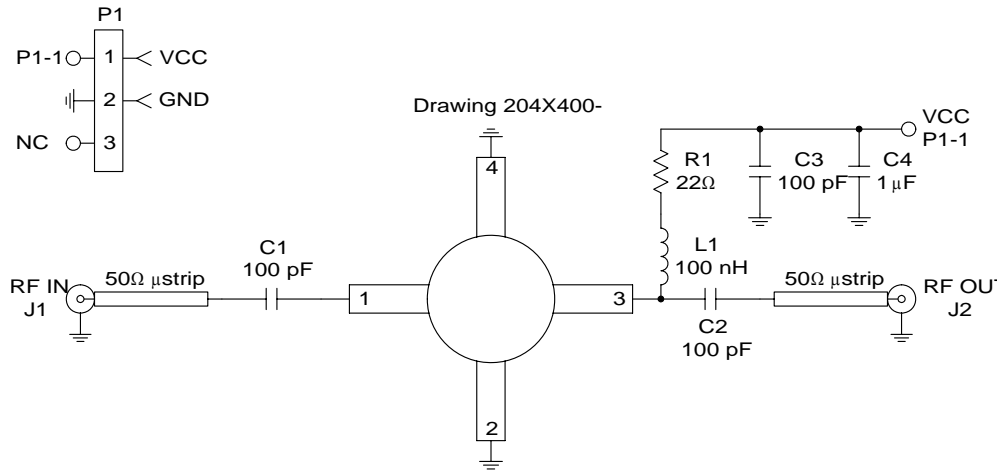

Evaluation Board Layout
Board Size 1.195" x 1.000"

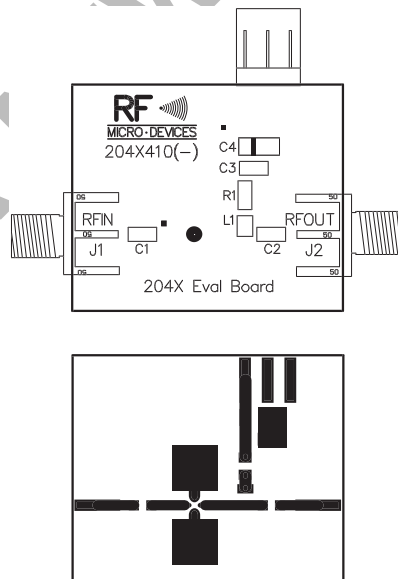

Reverse Isolation versus Frequency Across Temperature
 $I_{CC}=40\text{mA}$

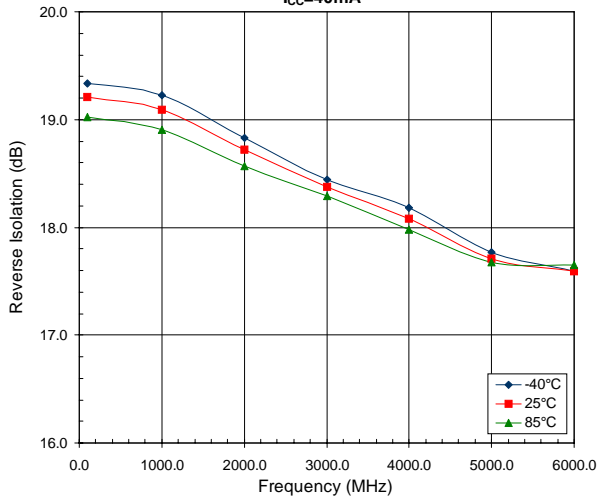

Typical Current versus Voltage
 (At Evaluation Board Connector, $R_{BIAS}=22\ \Omega$)

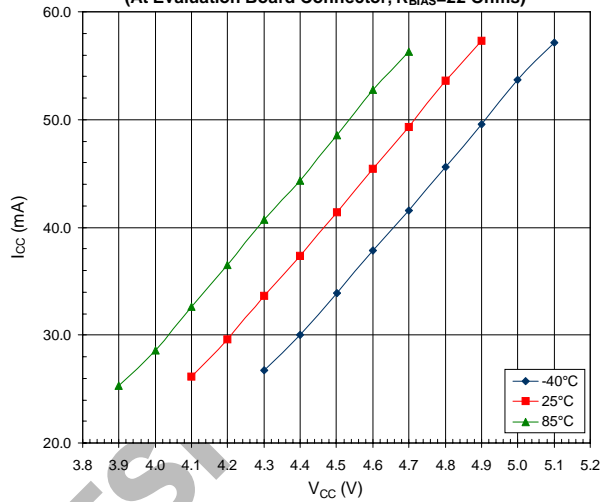

Typical I_{CC} versus V_{PIN}
 (At pin 3)

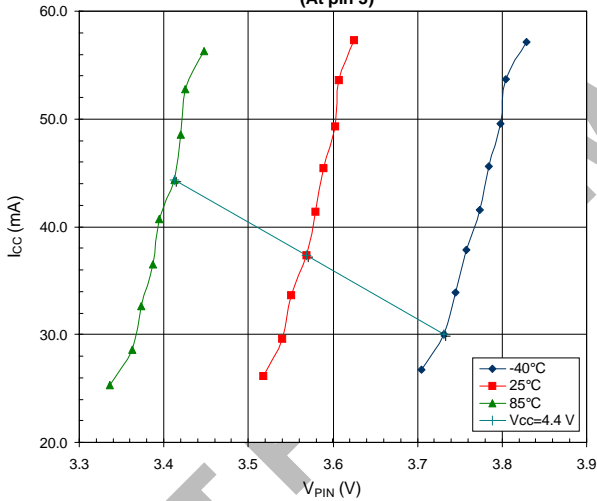

Power Dissipated versus Voltage at Pin 3
 ($T_{AMBIENT}=85^\circ\text{C}$)

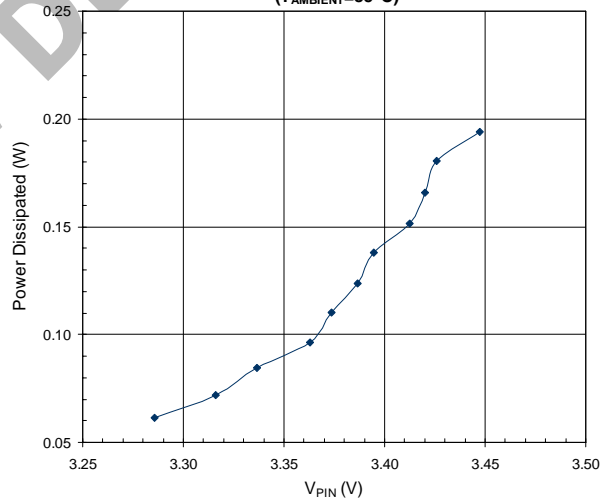

T_{MAX} versus P_{DISS}
 ($T_{AMBIENT}=85^\circ\text{C}$)

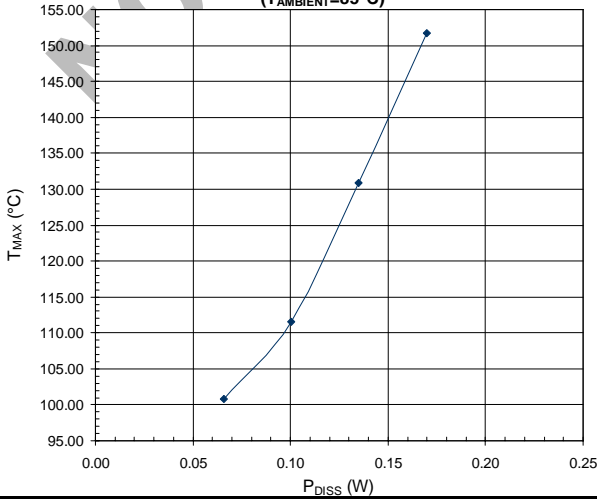

MTTF versus Junction Temperature (Valid for $I_{CC}\leq 40\text{mA}$)
 RFMD HBT2um AlGaAs-2 (60% Confidence Interval)

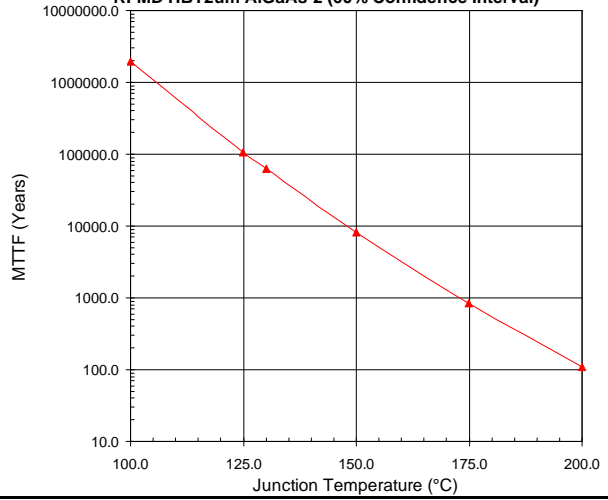

Gain versus Frequency Across Temperature
I_{CC}=40mA

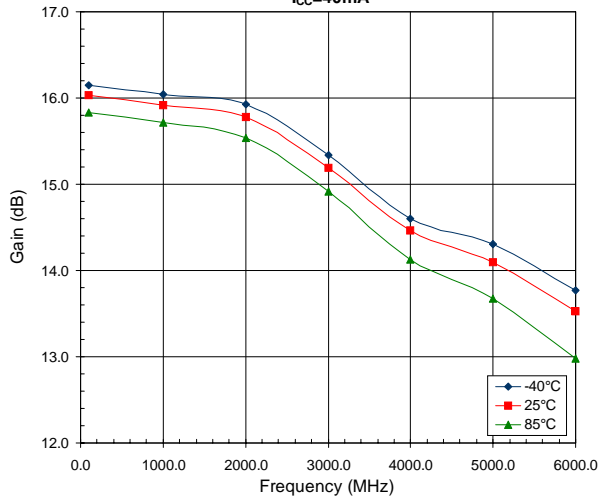

Output P1dB versus Frequency Across Temperature
I_{CC}=40mA

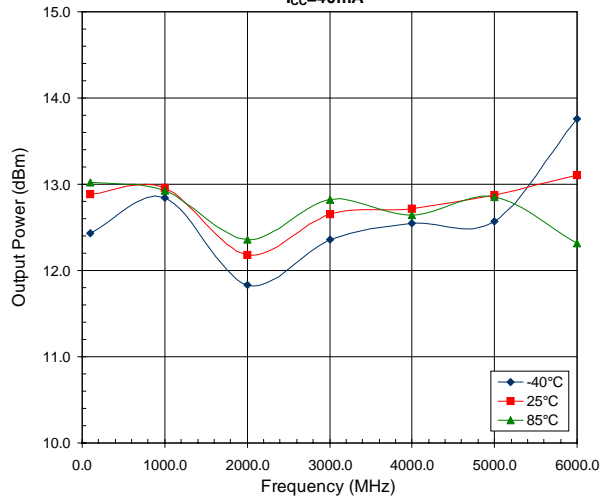

Output IP3 versus Frequency Across Temperature
I_{CC}=40mA

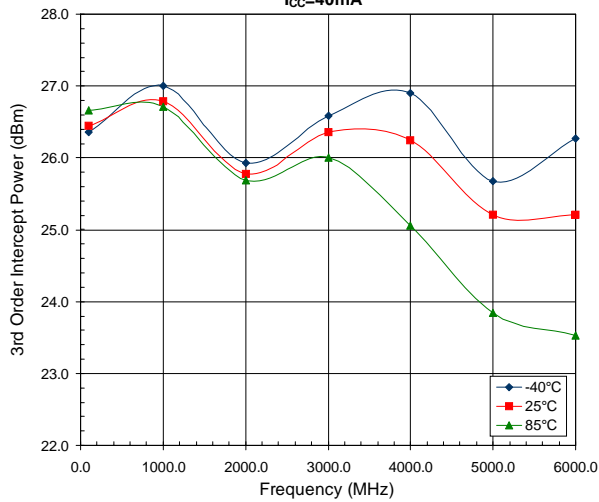

Noise Figure versus Frequency Across Temperature
I_{CC}=40mA

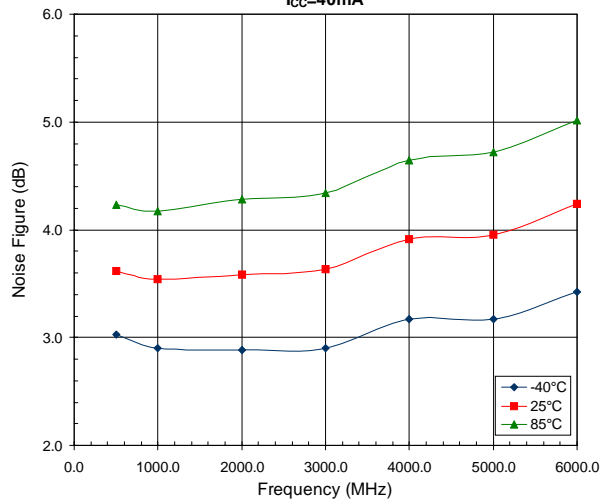

Input VSWR versus Frequency Across Temperature
I_{CC}=40mA

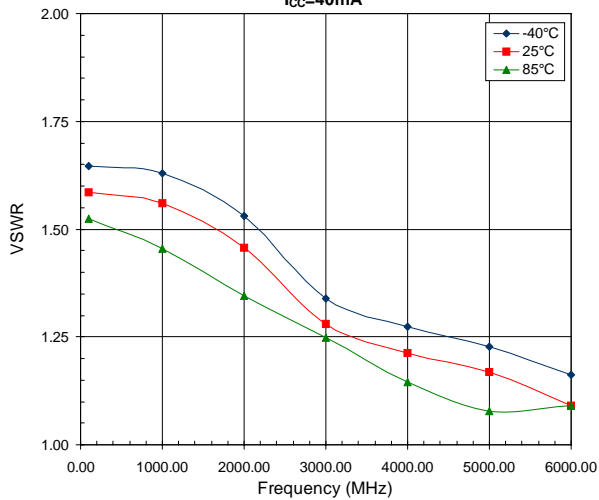

Output VSWR versus Frequency Across Temperature
I_{CC}=40mA

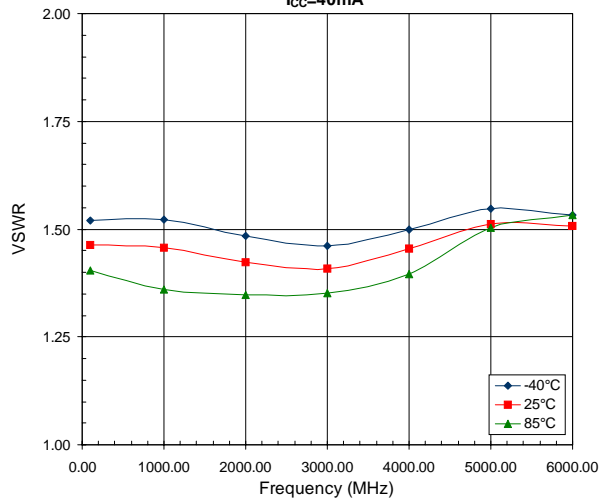

PCB Design Requirements

PCB Surface Finish

The PCB surface finish used for RFMD's qualification process is Electroless Nickel, immersion Gold. Typical thickness is 3µinch to 8µinch Gold over 180µinch Nickel.

PCB Land Pattern Recommendation

PCB land patterns are based on IPC-SM-782 standards when possible. The pad pattern shown has been developed and tested for optimized assembly at RFMD; however, it may require some modifications to address company specific assembly processes. The PCB land pattern has been developed to accommodate lead and package tolerances.

PCB Metal Land Mask Pattern

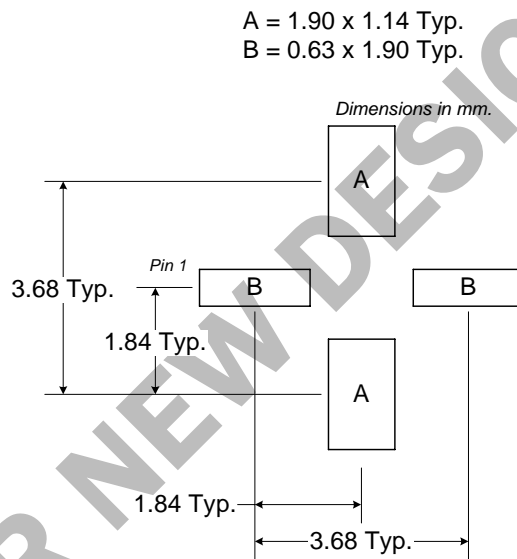

Figure 1. PCB Metal Land Pattern - RF204X (Top View)

PCB Solder Mask Pattern

Liquid Photo-Imageable (LPI) solder mask is recommended. The solder mask footprint will match what is shown for the PCB metal land pattern with a 2mil to 3mil expansion to accommodate solder mask registration clearance around all pads. The center-grounding pad shall also have a solder mask clearance. Expansion of the pads to create solder mask clearance can be provided in the master data or requested from the PCB fabrication supplier.

A = 2.06 x 1.30 Typ.
B = 0.79 x 2.06 Typ.

Dimensions in mm.

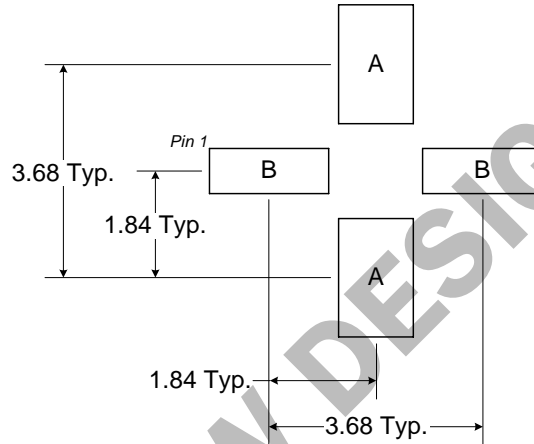

Figure 2. PCB Solder Mask - RF204X (Top View)

NOT FOR NEW DESIGNS

NOT FOR NEW DESIGNS