

## 1.5mm Side Looking Phototransistor EAPLP04RRKA0

### Features

- Fast response time
- High sensitivity
- Small junction capacitance
- Pb Free
- This product itself will remain within RoHS compliant version.

### Description

- EAPLP04RRKA0 is a phototransistor in miniature package which is molded in a black plastic with spherical top view lens. The device is spectrally matched to infrared emitting diode.

### Applications

- Optoelectronic switch
- VCR · Video Camera
- Floppy disk drive
- Infrared applied system

## Device Selection Guide

Chip Materials	Lens Color
Silicon	Black

## Absolute Maximum Ratings (Ta=25°C)

Parameter	Symbol	Rating	Unit
Collector-Emitter Voltage	$V_{CEO}$	30	V
Emitter-Collector-Voltage	$V_{ECO}$	5	V
Collector Current	$I_C$	40	mA
Operating Temperature	$T_{opr}$	-25~+85	°C
Storage Temperature	$T_{stg}$	-40~ +100	°C
Lead Soldering Temperature	$T_{sol}$	260	°C
Power Dissipation at (or below) 25°C Free Air Temperature	$P_c$	75	mW

**Notes:** \*1: Soldering time  $\leq$  5 seconds.

### Electro-Optical Characteristics (Ta=25°C)

Parameter	Symbol	Min.	Typ.	Max.	Unit	Condition
Collector – Emitter Breakdown Voltage	$BV_{CEO}$	30	-----	-----	V	$I_C=100\mu A$ $E_e=0mW/cm^2$
Emitter-Collector Breakdown Voltage	$BV_{ECO}$	5	-----	-----	V	$I_E=100\mu A$ $E_e=0mW/cm^2$
Collector-Emitter Saturation Voltage	$V_{CE(sat)}$	-----	-----	0.4	V	$I_C=2mA$ $E_e=1mW/cm^2$
Rise Time	$t_r$	-----	15	-----	$\mu S$	$V_{CE}=5V$ $I_C=1mA$ $RL=1000\Omega$
Fall Time	$t_f$	-----	15	-----		
Collector Dark Current	$I_{CEO}$	-----	-----	100	nA	$E_e=0mW/cm^2$ $V_{CE}=20V$
On State Collector Current	$I_{C(on)}$	0.53	-----	3.41	mA	$E_e=0.555mW/cm^2$ $V_{CE}=5V$
Rang Of Spectral Bandwidth	$\lambda_{0.5}$	700	-----	1200	nm	----
Wavelength of Peak Sensitivity	$\lambda_P$	-----	940	-----	nm	----

### Ranks

Parameter	Symbol	Min	Max	Unit	Test condition
7-3	$I_{C(ON)}$	0.53	1.19	mA	$V_{CE}=5V$ $E_e=0.555mW/cm^2$
7-2		0.88	1.70		
7-1		1.24	2.21		
6-2		1.59	2.98		
6-1		1.77	3.41		

**Typical Electro-Optical Characteristics Curves**

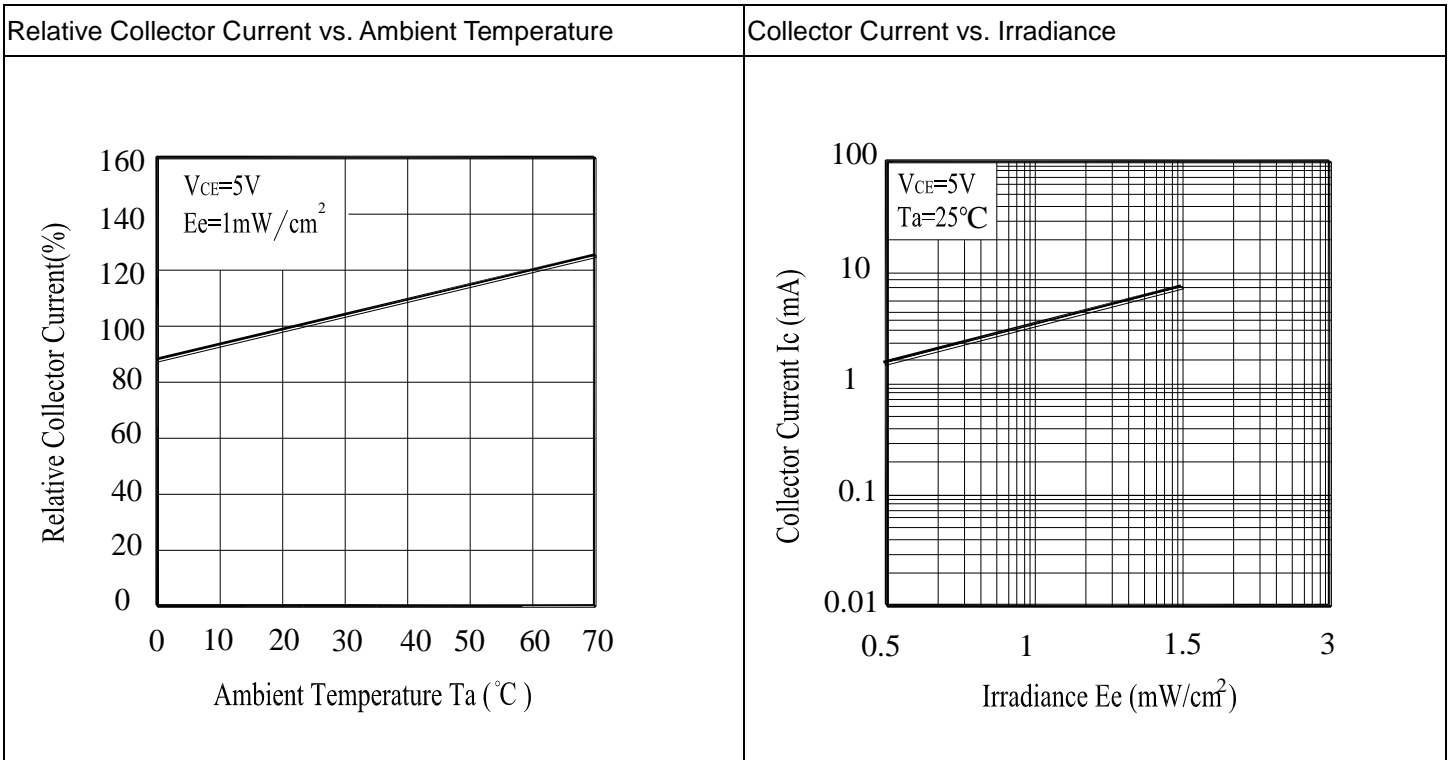
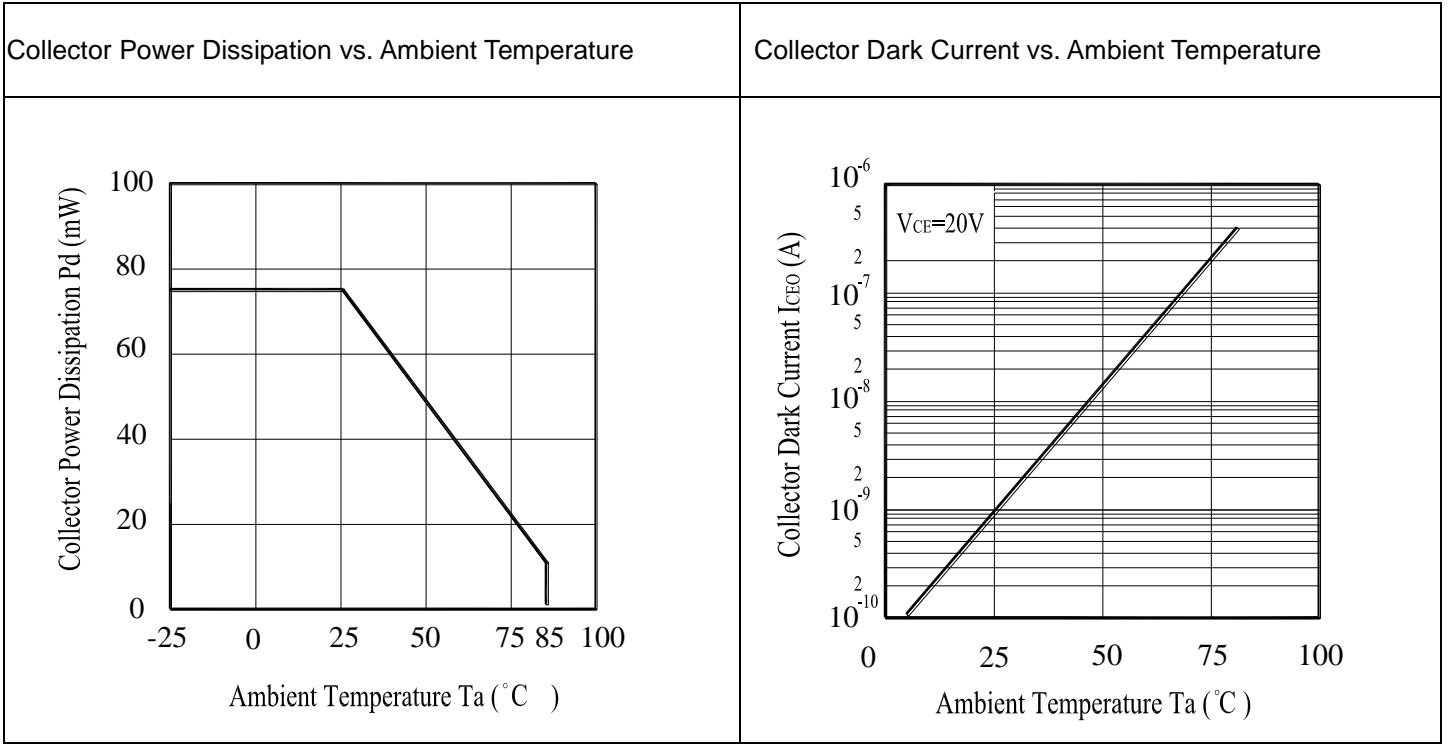

Spectral Sensitivity

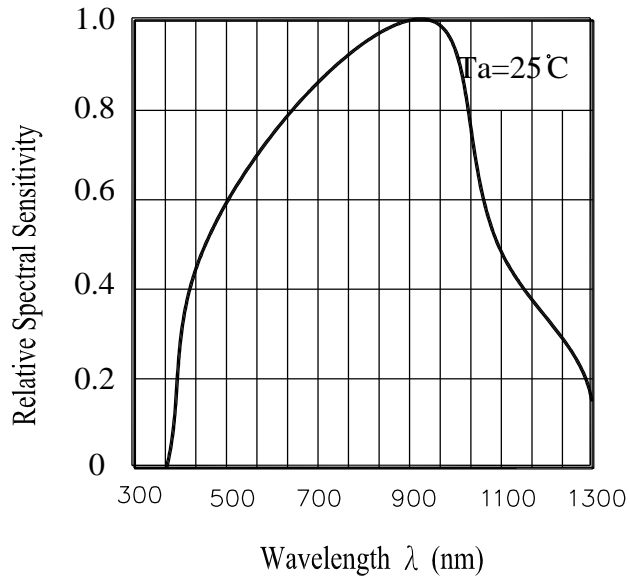

Collector Current vs. Collector-Emitter Voltage

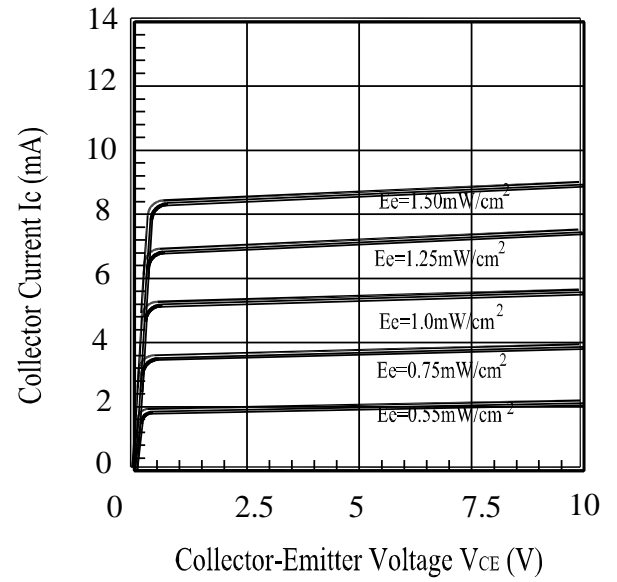

**Test method**

Light current test method for PT:

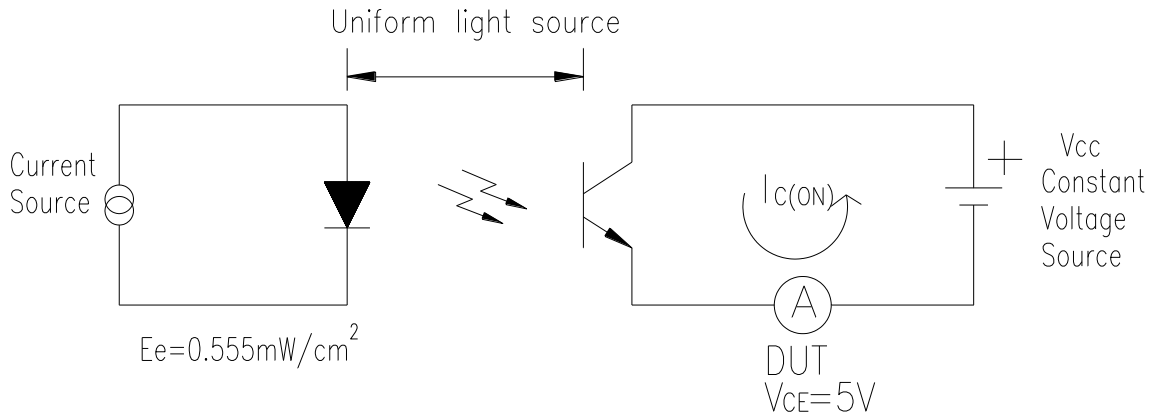

**Package Dimension**

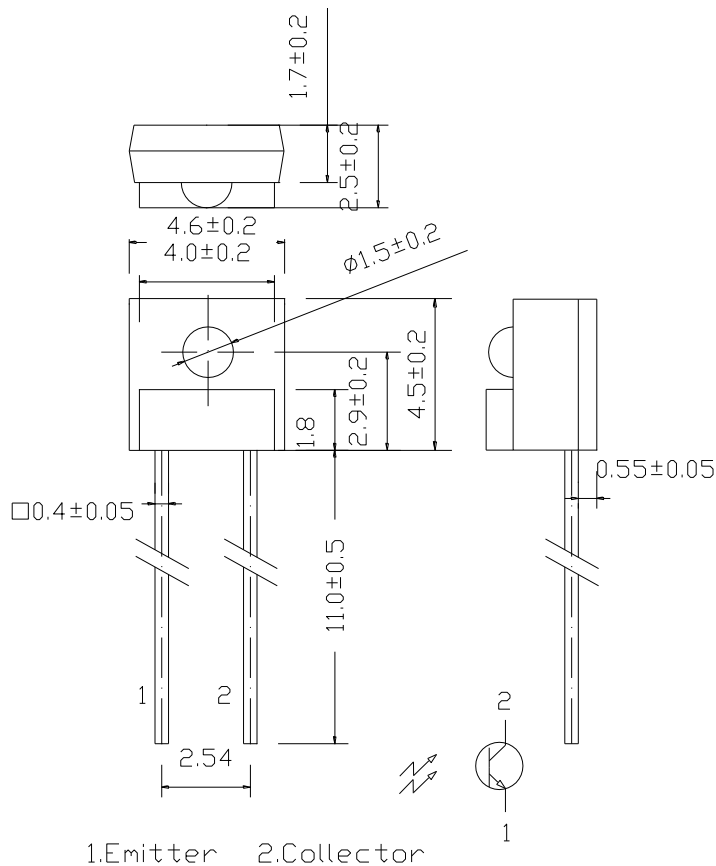

Note: Tolerances unless dimensions  $\pm 0.25\text{mm}$

**Packing Quantity Specification**

1. 1000PCS/1Bag,10Bags/1Box
2. 10Boxes/1Carton

**Label Explanation**

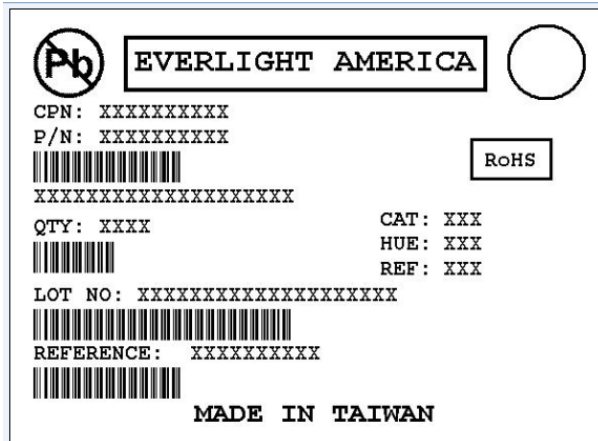

- CPN: Customer's Product Number
- P/N: Product Number
- QTY: Packing Quantity
- CAT: Luminous Intensity Rank
- HUE: Dom. Wavelength Rank
- REF: Forward Voltage Rank
- LOT No: Lot Number
- X: Month
- Reference: Identify Label Number

**Notes**

1. Above specification may be changed without notice. EVERLIGHT Americas will reserve authority on material change for above specification.
2. When using this product, please observe the absolute maximum ratings and the instructions for using outlined in these specification sheets. EVERLIGHT Americas assumes no responsibility for any damage resulting from use of the product which does not comply with the absolute maximum ratings and the instructions included in these specification sheets.
3. These specification sheets include materials protected under copyright of EVERLIGHT Americas corporation. Please don't reproduce or cause anyone to reproduce them without EVERLIGHT's Americas consent.