

Product Summary

BV_{DSS}	$R_{DS(ON) \max}$	I_D $T_C = +25^\circ C$
-40V	10mΩ @ $V_{GS} = -10V$	-50A
	14mΩ @ $V_{GS} = -4.5V$	-40A

Description and Applications

This MOSFET is designed to meet the stringent requirements of Automotive applications. It is qualified to AEC-Q101, supported by a PPAP and is ideal for use in:

- Reverse Polarity Protection
- BLDC Motor Control
- Power Management Functions

Features and Benefits

- Rated to +175°C – Ideal for High Ambient Temperature Environments
- 100% Unclamped Inductive Switch (UIS) Test in Production Low On-resistance
- Fast Switching Speed
- Lead-Free Finish; RoHS Compliant (Notes 1 & 2)**
- Halogen and Antimony Free. "Green" Device (Note 3)**
- Qualified to AEC-Q101 Standards for High Reliability**
- PPAP Capable (Note 4)**

Mechanical Data

- Case: PowerDI[®] 5060-8
- Case Material: Molded Plastic, "Green" Molding Compound. UL Flammability Classification Rating 94V-0
- Moisture Sensitivity: Level 1 per J-STD-020
- Terminal Connections: See Diagram
- Terminals: Finish – 100% Matte Tin Annealed over Copper Leadframe. Solderable per MIL-STD-202, Method 208
- Weight: 0.097 grams (Approximate)



Top View

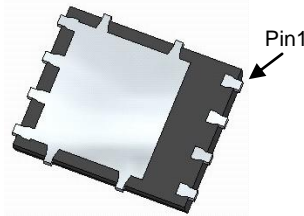

Bottom View

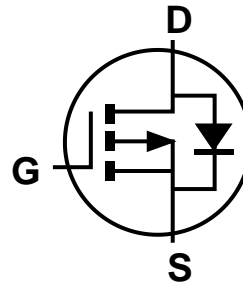

Internal Schematic

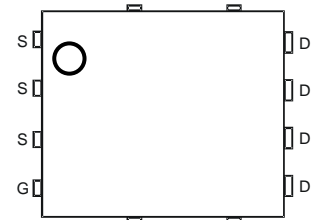

Top View
Pin Configuration

Ordering Information (Note 5)

Part Number	Case	Packaging
DMPH4015SPSQ-13	PowerDI5060-8	2,500 / Tape & Reel

- Notes:
- EU Directive 2002/95/EC (RoHS), 2011/65/EU (RoHS 2) & 2015/863/EU (RoHS 3) compliant. All applicable RoHS exemptions applied.
 - See <https://www.diodes.com/quality/lead-free/> for more information about Diodes Incorporated's definitions of Halogen- and Antimony-free, "Green" and Lead-free.
 - Halogen- and Antimony-free "Green" products are defined as those which contain <900ppm bromine, <900ppm chlorine (<1500ppm total Br + Cl) and <1000ppm antimony compounds.
 - Automotive products are AEC-Q101 qualified and are PPAP capable. Please refer to <https://www.diodes.com/quality/>.
 - For packaging details, go to our website at <https://www.diodes.com/design/support/packaging/diodes-packaging/>.

Marking Information

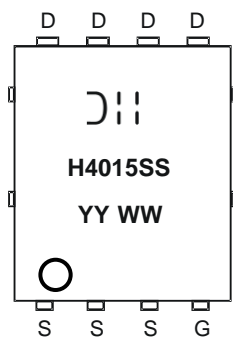

- = Manufacturer's Marking
- H4015SS = Product Type Marking Code
- YYWW = Date Code Marking
- YY = Year (ex: 18 = 2018)
- WW = Week (01 to 53)

Maximum Ratings (@T_A = +25°C, unless otherwise specified.)

Characteristic	Symbol	Value	Unit	
Drain-Source Voltage	V _{DSS}	-40	V	
Gate-Source Voltage	V _{GSS}	±25	V	
Continuous Drain Current V _{GS} = -10V (Note 7)	I _D	T _C = +25°C	-50	A
		T _C = +100°C	-35	A
Continuous Drain Current V _{GS} = -10V (Note 6)	I _D	T _A = +25°C	-12.0	A
		T _A = +100°C	-9.0	A
Pulsed Drain Current (10µs Pulse, Duty Cycle = 1%)	I _{DM}	-100	A	
Maximum Body Diode Continuous Current (Note 8)	I _S	-50	A	
Avalanche Current (Note 9) L = 1mH	I _{AS}	-22	A	
Avalanche Energy (Note 9) L = 1mH	E _{AS}	260	mJ	

Thermal Characteristics (@T_A = +25°C, unless otherwise specified.)

Characteristic	Symbol	Value	Unit
Total Power Dissipation (Note 6)	P _D	1.5	W
Thermal Resistance, Junction to Ambient (Note 6)	R _{θJA}	98	°C/W
Total Power Dissipation (Note 7)	P _D	2.6	W
Thermal Resistance, Junction to Ambient (Note 7)	R _{θJA}	57.0	°C/W
Thermal Resistance, Junction to Case (Note 8)	R _{θJC}	0.9	°C/W
Operating and Storage Temperature Range	T _J , T _{STG}	-55 to +175	°C

Electrical Characteristics (@T_A = +25°C, unless otherwise specified.)

Characteristic	Symbol	Min	Typ	Max	Unit	Test Condition
OFF CHARACTERISTICS (Note 10)						
Drain-Source Breakdown Voltage	BV _{DSS}	-40	—	—	V	V _{GS} = 0V, I _D = -250µA
Zero Gate Voltage Drain Current	I _{DSS}	—	—	-1	µA	V _{DS} = -40V, V _{GS} = 0V
Gate-Source Leakage	I _{GSS}	—	—	±100	nA	V _{GS} = ±25V, V _{DS} = 0V
ON CHARACTERISTICS (Note 10)						
Gate Threshold Voltage	V _{GS(TH)}	-1.5	-2	-2.5	V	V _{DS} = V _{GS} , I _D = -250µA
Static Drain-Source On-Resistance	R _{DS(ON)}	—	8	10	mΩ	V _{GS} = -10V, I _D = -9.8A
		—	11	14		V _{GS} = -4.5V, I _D = -9.8A
Diode Forward Voltage	V _{SD}	—	-0.7	-1	V	V _{GS} = 0V, I _S = -1A
DYNAMIC CHARACTERISTICS (Note 11)						
Input Capacitance	C _{iss}	—	4234	—	pF	V _{DS} = -20V, V _{GS} = 0V f = 1MHz
Output Capacitance	C _{oss}	—	1036	—		
Reverse Transfer Capacitance	C _{riss}	—	526	—		
Gate Resistance	R _g	—	7.8	—	Ω	V _{DS} = 0V, V _{GS} = 0V, f = 1MHz
Total Gate Charge (V _{GS} = -4.5V)	Q _g	—	42.7	—	nC	V _{DS} = -20V, I _D = -9.8A
Total Gate Charge (V _{GS} = -10V)	Q _g	—	91	—		
Gate-Source Charge	Q _{gs}	—	14.2	—		
Gate-Drain Charge	Q _{gd}	—	13.5	—		
Turn-On Delay Time	t _{D(ON)}	—	13.2	—	ns	V _{GS} = -10V, V _{DD} = -20V, R _G = 6Ω, I _D = -1A
Turn-On Rise Time	t _r	—	10	—		
Turn-Off Delay Time	t _{D(OFF)}	—	303	—		
Turn-Off Fall Time	t _f	—	138	—		
Reverse Recovery Time	t _{RR}	—	26	—	ns	I _F = -9.8A, di/dt = -100A/µs
Reverse Recovery Charge	Q _{RR}	—	20	—	nC	I _F = -9.8A, di/dt = -100A/µs

- Notes:
6. Device mounted on FR-4 PC board, with minimum recommended pad layout, single sided.
 7. Device mounted on FR-4 substrate PC board, 2oz copper, with thermal bias to bottom layer 1inch square copper plate.
 8. Thermal resistance from junction to soldering point (on the exposed drain pad).
 9. I_{AS} and E_{AS} ratings are based on low frequency and duty cycles to keep T_J = +25°C.
 10. Short duration pulse test used to minimize self-heating effect.
 11. Guaranteed by design. Not subject to product testing.

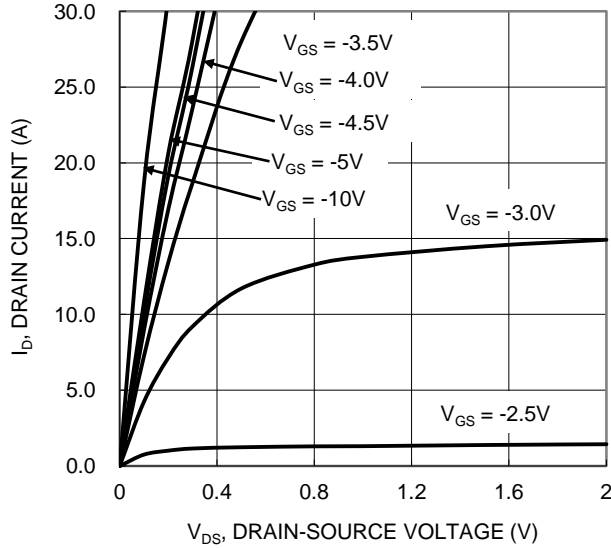

Figure 1. Typical Output Characteristic

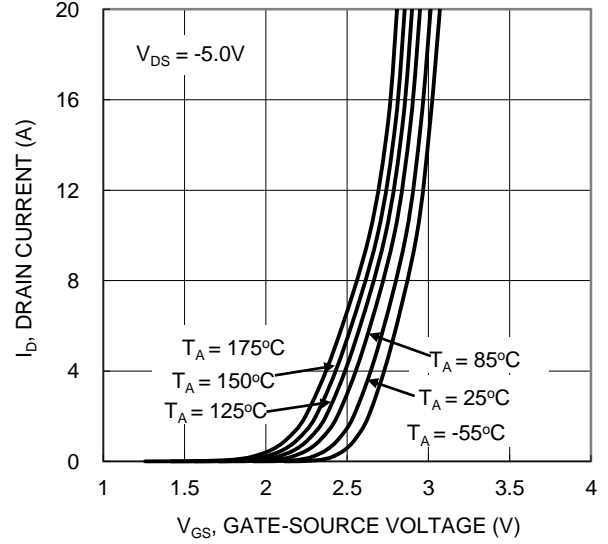

Figure 2. Typical Transfer Characteristic

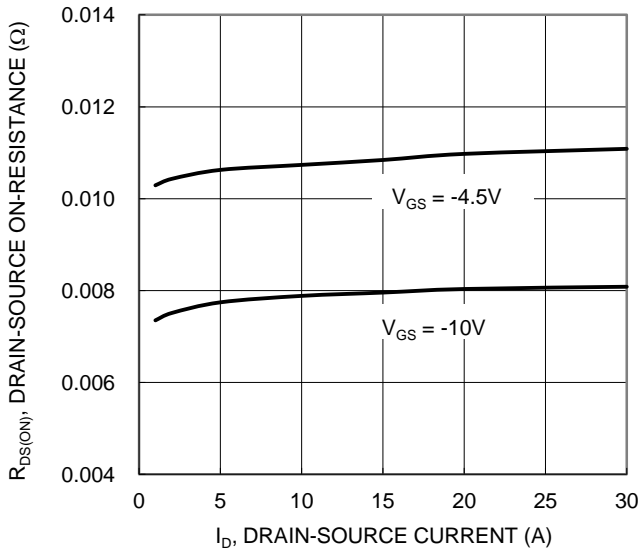

Figure 3. Typical On-Resistance vs. Drain Current and Gate Voltage

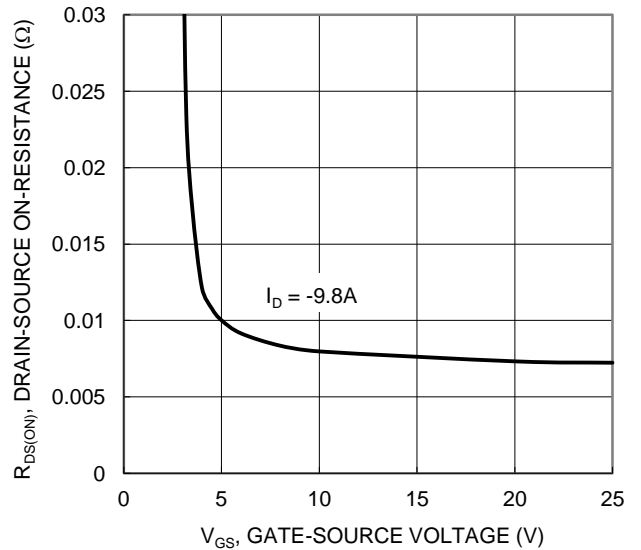

Figure 4. Typical Transfer Characteristic

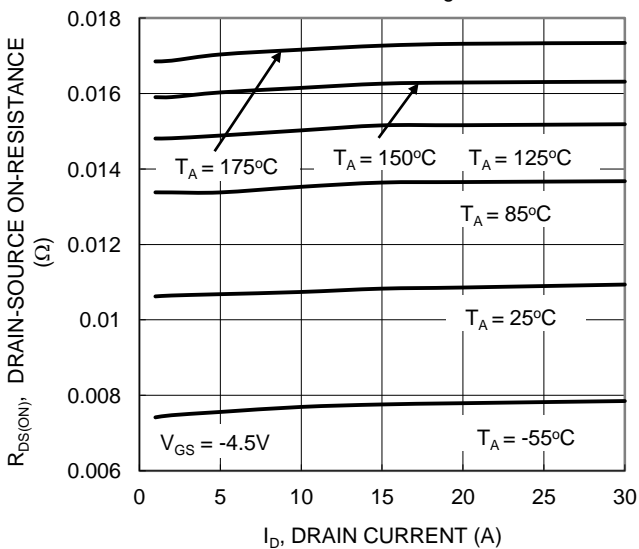

Figure 5. Typical On-Resistance vs. Drain Current and Temperature

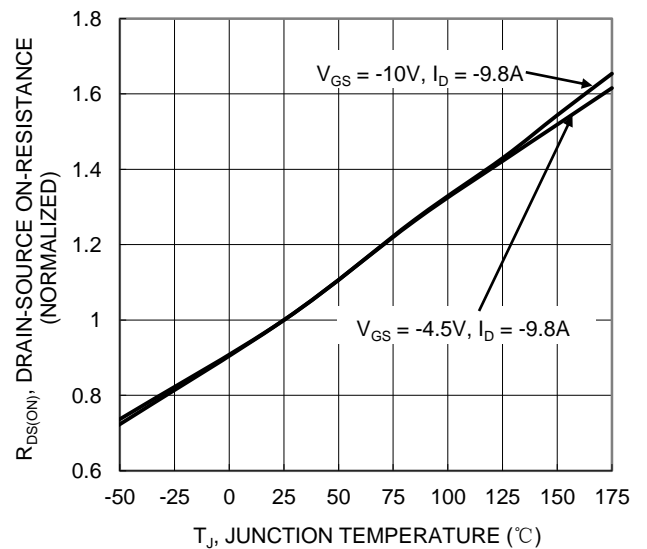
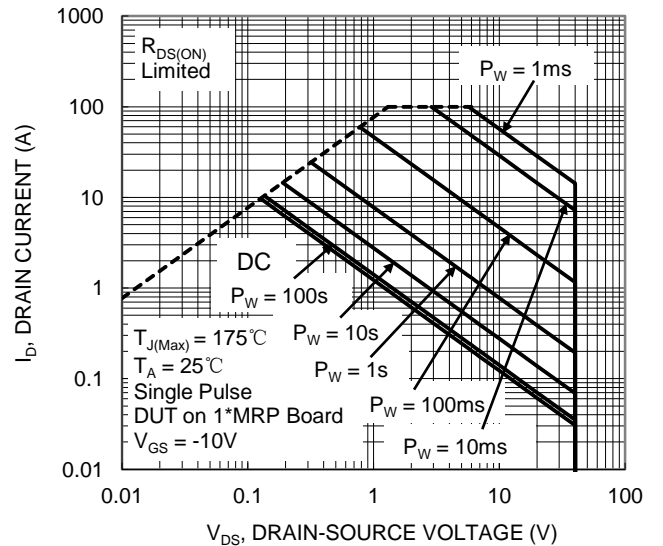
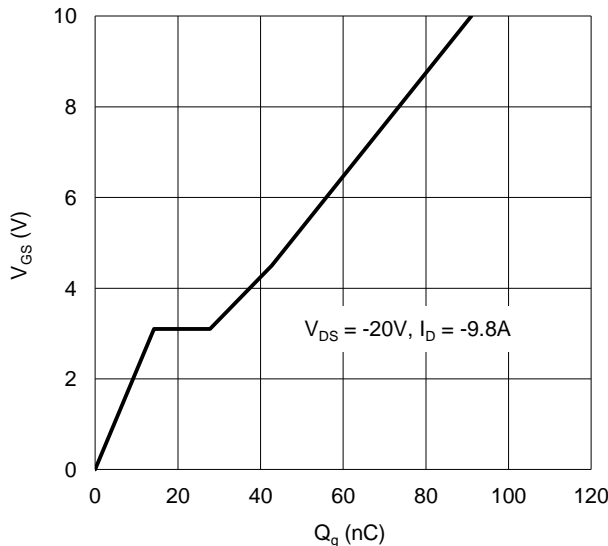
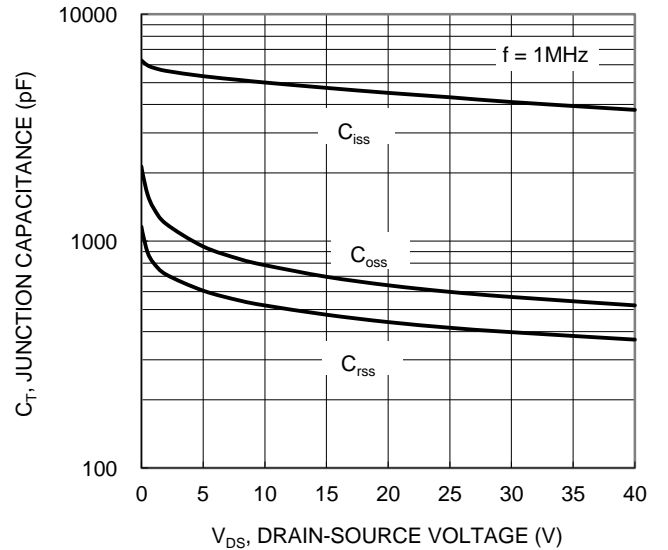
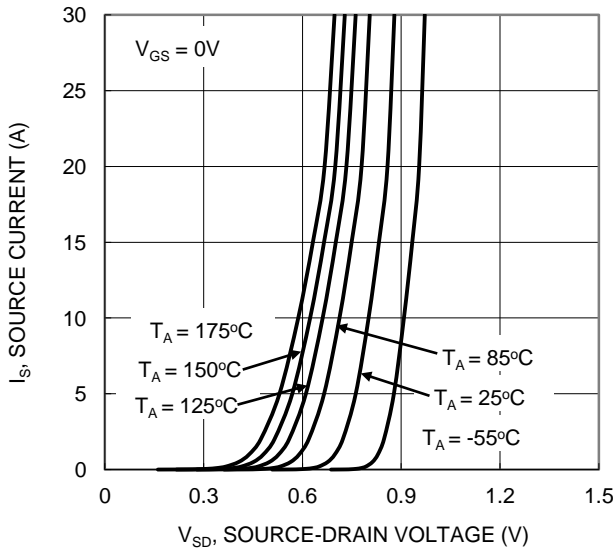
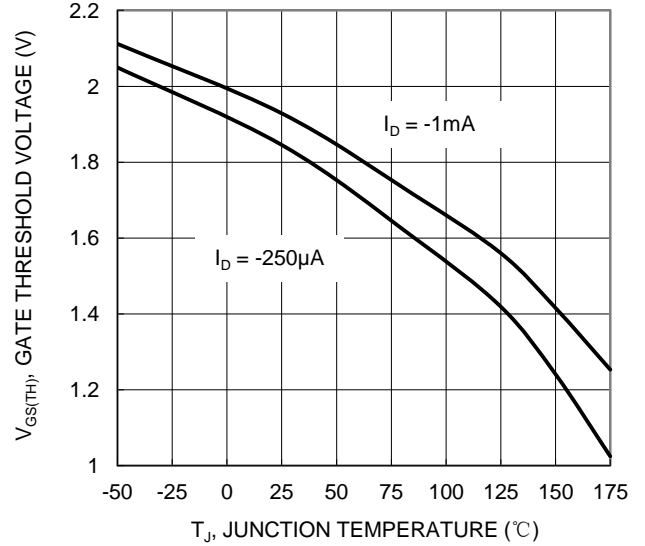
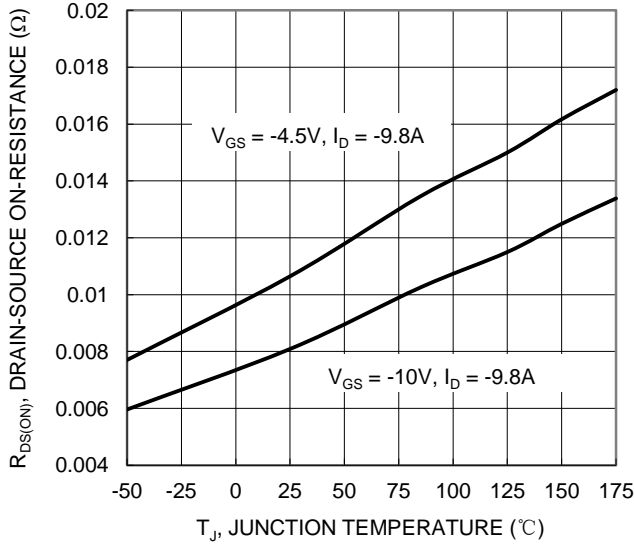

Figure 6. On-Resistance Variation with Temperature



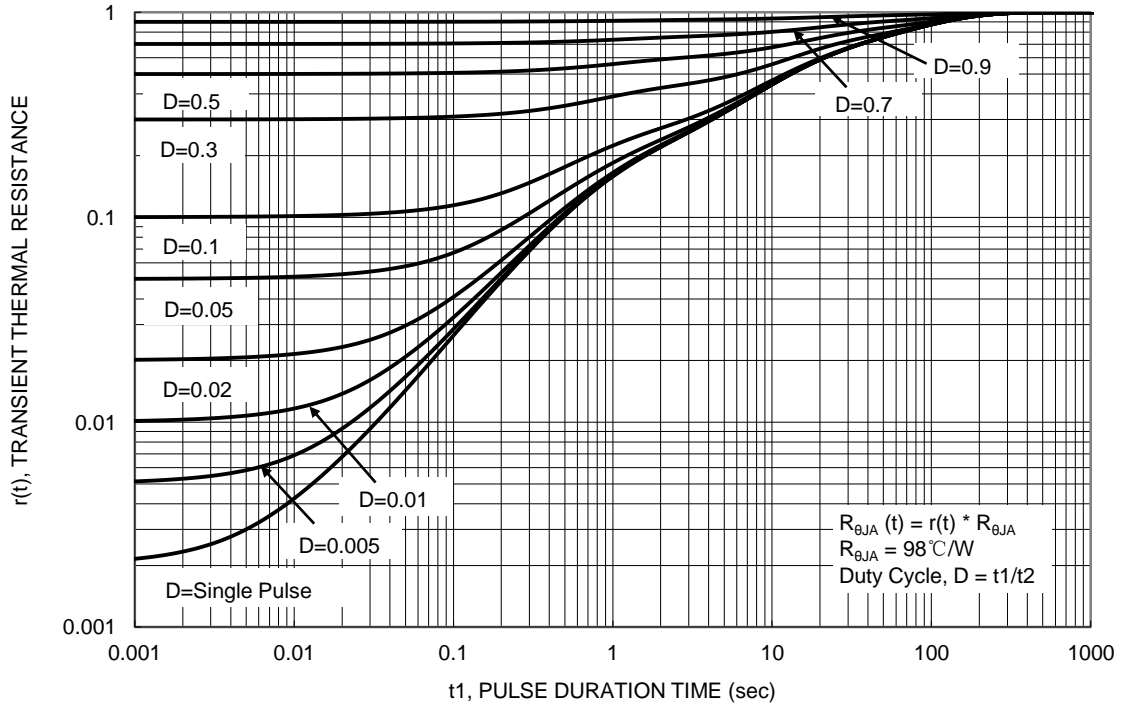
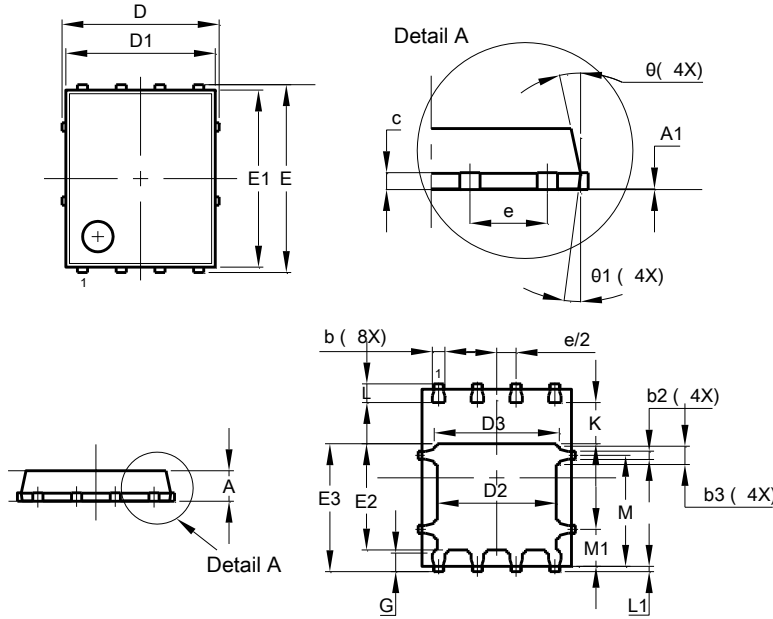

Figure 13. Transient Thermal Resistance

Package Outline Dimensions

Please see <http://www.diodes.com/package-outlines.html> for the latest version.

PowerDI5060-8



PowerDI5060-8			
Dim	Min	Max	Typ
A	0.90	1.10	1.00
A1	0.00	0.05	–
b	0.33	0.51	0.41
b2	0.200	0.350	0.273
b3	0.40	0.80	0.60
c	0.230	0.330	0.277
D	5.15 BSC		
D1	4.70	5.10	4.90
D2	3.70	4.10	3.90
D3	3.90	4.30	4.10
E	6.15 BSC		
E1	5.60	6.00	5.80
E2	3.28	3.68	3.48
E3	3.99	4.39	4.19
e	1.27 BSC		
G	0.51	0.71	0.61
K	0.51	–	–
L	0.51	0.71	0.61
L1	0.100	0.200	0.175
M	3.235	4.035	3.635
M1	1.00	1.40	1.21
Theta	10°	12°	11°
Theta1	6°	8°	7°
All Dimensions in mm			

Suggested Pad Layout

Please see <http://www.diodes.com/package-outlines.html> for the latest version.

PowerDI5060-8

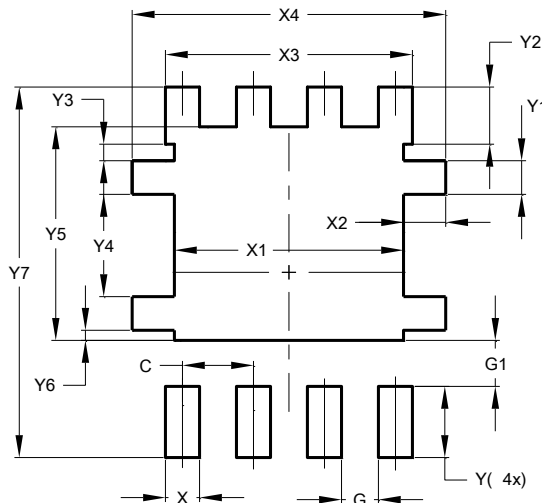

Dimensions	Value (in mm)
C	1.270
G	0.660
G1	0.820
X	0.610
X1	4.100
X2	0.755
X3	4.420
X4	5.610
Y	1.270
Y1	0.600
Y2	1.020
Y3	0.295
Y4	1.825
Y5	3.810
Y6	0.180
Y7	6.610

IMPORTANT NOTICE

DIODES INCORPORATED MAKES NO WARRANTY OF ANY KIND, EXPRESS OR IMPLIED, WITH REGARDS TO THIS DOCUMENT, INCLUDING, BUT NOT LIMITED TO, THE IMPLIED WARRANTIES OF MERCHANTABILITY AND FITNESS FOR A PARTICULAR PURPOSE (AND THEIR EQUIVALENTS UNDER THE LAWS OF ANY JURISDICTION).

Diodes Incorporated and its subsidiaries reserve the right to make modifications, enhancements, improvements, corrections or other changes without further notice to this document and any product described herein. Diodes Incorporated does not assume any liability arising out of the application or use of this document or any product described herein; neither does Diodes Incorporated convey any license under its patent or trademark rights, nor the rights of others. Any Customer or user of this document or products described herein in such applications shall assume all risks of such use and will agree to hold Diodes Incorporated and all the companies whose products are represented on Diodes Incorporated website, harmless against all damages.

Diodes Incorporated does not warrant or accept any liability whatsoever in respect of any products purchased through unauthorized sales channel. Should Customers purchase or use Diodes Incorporated products for any unintended or unauthorized application, Customers shall indemnify and hold Diodes Incorporated and its representatives harmless against all claims, damages, expenses, and attorney fees arising out of, directly or indirectly, any claim of personal injury or death associated with such unintended or unauthorized application.

Products described herein may be covered by one or more United States, international or foreign patents pending. Product names and markings noted herein may also be covered by one or more United States, international or foreign trademarks.

This document is written in English but may be translated into multiple languages for reference. Only the English version of this document is the final and determinative format released by Diodes Incorporated.

LIFE SUPPORT

Diodes Incorporated products are specifically not authorized for use as critical components in life support devices or systems without the express written approval of the Chief Executive Officer of Diodes Incorporated. As used herein:

A. Life support devices or systems are devices or systems which:

1. are intended to implant into the body, or
2. support or sustain life and whose failure to perform when properly used in accordance with instructions for use provided in the labeling can be reasonably expected to result in significant injury to the user.

B. A critical component is any component in a life support device or system whose failure to perform can be reasonably expected to cause the failure of the life support device or to affect its safety or effectiveness.

Customers represent that they have all necessary expertise in the safety and regulatory ramifications of their life support devices or systems, and acknowledge and agree that they are solely responsible for all legal, regulatory and safety-related requirements concerning their products and any use of Diodes Incorporated products in such safety-critical, life support devices or systems, notwithstanding any devices- or systems-related information or support that may be provided by Diodes Incorporated. Further, Customers must fully indemnify Diodes Incorporated and its representatives against any damages arising out of the use of Diodes Incorporated products in such safety-critical, life support devices or systems.

Copyright © 2018, Diodes Incorporated

www.diodes.com