

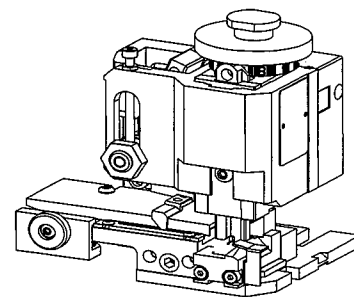

SPECIFICATION SHEET
FineAdjust Applicator
63861-8000
REVISION A



SCOPE

Terminal Series No	Wire Size		Insulation Diameter		Strip Length	
	Awg	(mm ²)	mm	(in)	mm	(in)
5378	24-28	(0.20-0.08)	0.90-1.50	(.035-.059)	1.70-2.30	(.067-.091)

DEFINITION OF TERMS

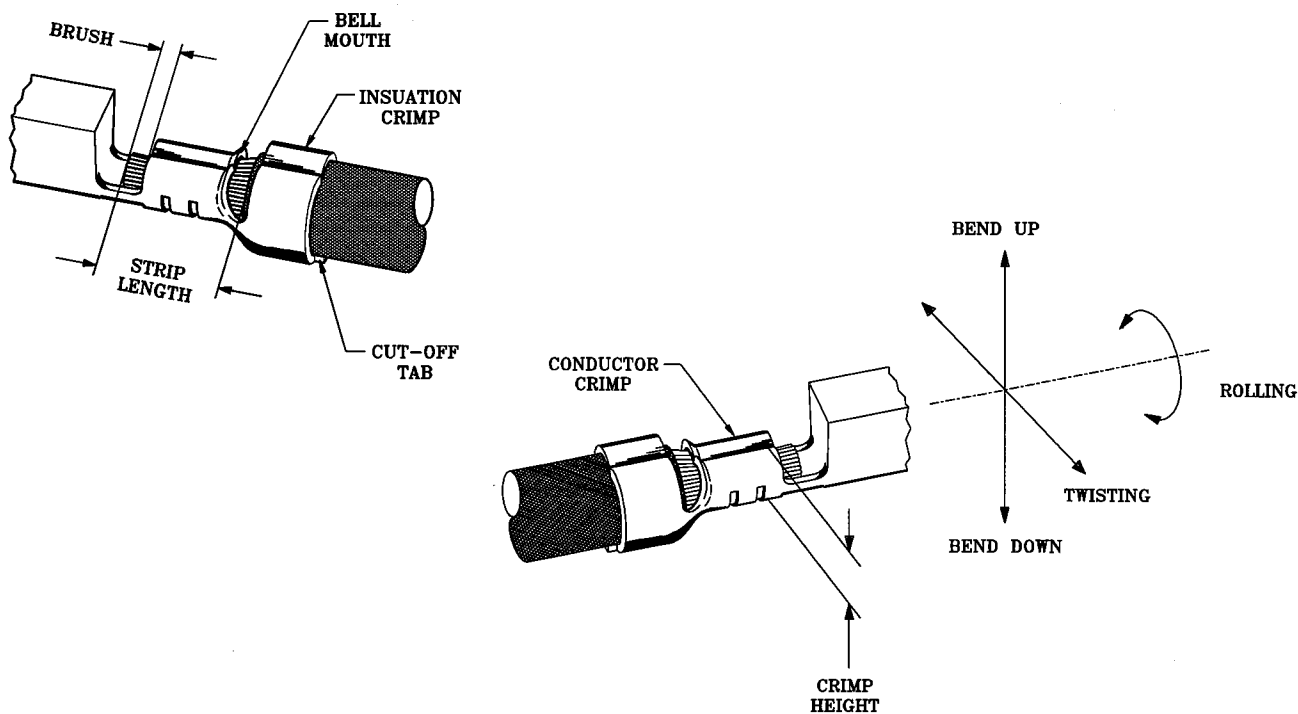

The above terminal drawing is a generic terminal representation. It is not an image of a terminal listed in the scope

SPECIFICATIONS

Terminal Series No.	Bellmouth		Cut-Off Tab Max.		Conductor Brush	
	mm	(in)	mm	(in)	mm	(in)
5378	0.20-0.50	(.008-.020)	0.30	(.012)	0.00-0.60	(.000-.024)

Terminal Series No.	Bend Up Bend Down		Twist	Roll	Punch Width mm	
	Degree				mm	Insulation
5378	4	4	3	8	1.20	1.40

The above specifications are guidelines to an optimum crimp.

CONDITIONS

After crimping, the conductor profile should measure the following.

Terminal Series	Wire Size		Crimp Height		Pull Force Min	
	Awg	(mm ²)	mm	(in)	N	(lbs)
5378	24	(0.20)	0.62-0.67	(.024-.026)	29.3	(6.6)
5378	26	(0.12)	0.57-0.62	(.022-.024)	19.6	(4.4)
5378	28	(0.08)	0.54-0.59	(.021-.023)	9.8	(2.2)

Pull Force measured with no influence from the insulation crimp

PARTS LIST

Item Number	Order Number	Eng Number	Description	Qty	Kit Part
1	634441207	634441207	Conductor Punch	1	Y
2	634451217	634451217	Conductor Anvil	1	Y
3	634461410	634461410	Insulation Punch	1	Y
4	634451414	634451414	Insulation Anvil	1	Y
5	634430003	634430003	Cut-Off Plunger	1	Y
6	634430012	634430012	Front Plunger Retainer	1	Y
7	11-24-1067	4996-4	Cut-Off Plunger Spring	1	
8	11-40-4039	8302-5	Front Plunger Striker	1	
9	634430021	634430021	Lower Tooling Key	1	
10	634436003	634436003	Rear Cover	1	
11	11-18-4083	60707-8	Front Cover	1	
12	634432404	634432404	Anvil Mount	1	
13	634434025	634434025	Wire Stop	1	
14	634430009	634430009	Scrap Chute	1	
15	638004900	638004900	FineAdjust Applicator	1	
70	638618070	638618070	Tool Kit (All "Y" Items)	0	

NOTES

1. We recommend an extra perishable tooling kit be maintained at your facility.
2. Verify tooling alignment by manually cycling the press and Applicator before crimping under power.
3. Slugs , Terminals, Dirt and Oil should be kept clear of work area.
4. This Applicator should only be used in a press with a shut height of 135.8 mm (5.346"). Tooling damage could result at a lower setting.
5. **** CAUTION**** To prevent injury never operate this Applicator without the guarding supplied with the press or wire processing machine in place. Reference the press or wire processing manufacturer's instruction manual.
6. Wear safety glasses at all times.

ASSEMBLY DRAWING

The drawing below is a generic drawing representation. Some detail may not be shown. The FineAdjust applicator assembly and parts list can be found in the FineAdjust manual.

