

Features

- * LOW POWER CONSUMPTION.
- * HIGH EFFICIENCY.
- * VERSATILE MOUNTING ON P.C. BOARD OR PANEL.
- * I.C. COMPATIBLE/LOW CURRENT REQUIREMENTS.
- * POPULAR T 13/4 DIAMETER.

Package Dimensions

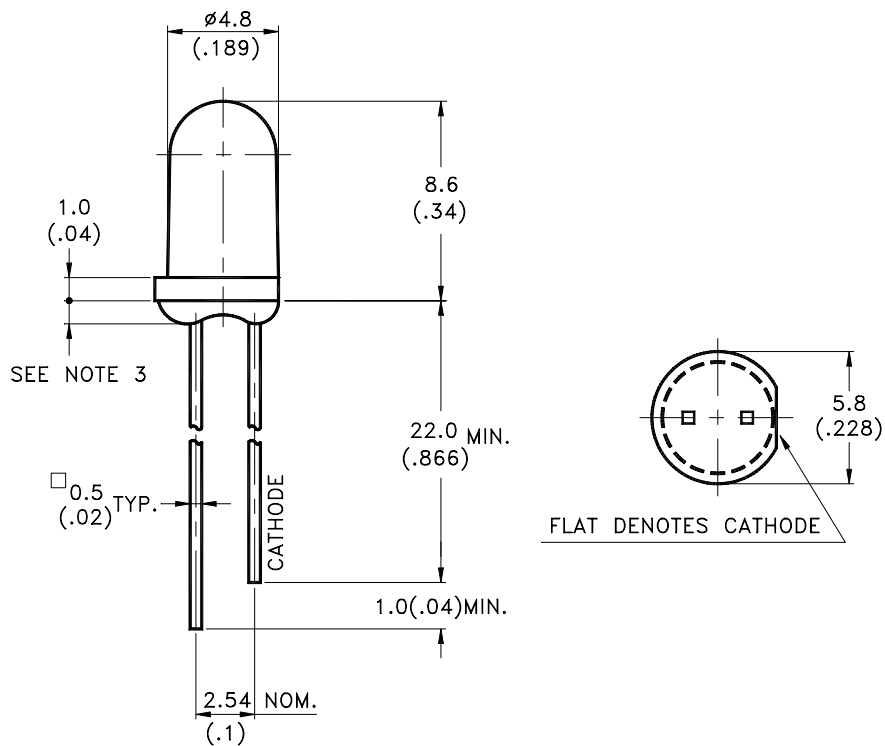

Part No.	Lens Color	Emitted Color
LTL33BCWK5AT	Water Clear	InGaN White

NOTES:

1. All dimensions are in millimeters (inches).
2. Tolerance is ± 0.25 mm(.010") unless otherwise noted.
3. Protruded resin under flange is 1.0mm(.04") max.
4. Lead spacing is measured where the leads emerge from the package.
5. Specifications are subject to change without notice.



LITE-ON TECHNOLOGY CORPORATION

Property of Lite-On Only

Absolute Maximum Ratings at $T_a=25^{\circ}\text{C}$

PARAMETER	LTL33BCWK5AT	UNIT
Power Dissipation	120	mW
Peak Forward Current (1/10 Duty Cycle, 0.1ms Pulse Width)	100	mA
DC Forward Current	30	mA
Reverse Voltage	5	V
Operating Temperature Range	-25 $^{\circ}\text{C}$ to + 80 $^{\circ}\text{C}$	
Storage Temperature Range	-30 $^{\circ}\text{C}$ to + 100 $^{\circ}\text{C}$	
Lead Soldering Temperature [1.6mm(.063") From Body]	260 $^{\circ}\text{C}$ for 5 Seconds	

Electrical / Optical Characteristics at Ta=25°C

PARAMETER	SYMBOL	MIN.	TYP.	MAX.	UNIT	TEST CONDITION
Luminous Intensity	I _v	2500	4800		mcd	I _F = 20mA Note 1,2,3,8 I _v Spec. Table
Viewing Angle	2θ _{1/2}		20		deg	Note 4,8
Chromaticity Coordinates	x		0.30			I _F = 20mA Note 5,8 Hue Spec. Table & Chromaticity Diagram
	y		0.33			
Forward Voltage	V _F		3.7	4.1	V	I _F = 20mA
Reverse Current	I _R			10	μA	V _R = 5V

NOTE: 1. Luminous intensity is measured with a light sensor and filter combination that approximates the CIE eye-response curve.

2. The I_v guarantee should be added ±15% tolerance.

3. I_v classification code is marked on each packing bag.

4. θ_{1/2} is the off-axis angle at which the luminous intensity is half the axial luminous intensity.

5. The chromaticity coordinates (x, y) is derived from the 1931 CIE chromaticity diagram.

6. Precautions in handling:

- When soldering, leave 2mm of minimum clearance from the resin to the soldering point.
- Dipping the resin to solder must be avoided.
- Correcting the soldered position after soldering must be avoided.
- In soldering, do not apply any stress to the lead frame particularly when heated.
- Lead forming must be done before soldering.
- It is necessary to cut the lead frame at normal temperature.

7. Caution in ESD:

Static Electricity and surge damages the LED. It is recommend to use a wrist band or anti-electrostatic glove when handling the LED. All devices, equipment and machinery must be properly grounded.

8. Tester

- PR704 is for the chromaticity coordinates (x, y).
- EG&G is for I_v.

Property of Lite-On Only

Typical Electrical / Optical Characteristics Curves

(25°C Ambient Temperature Unless Otherwise Noted)

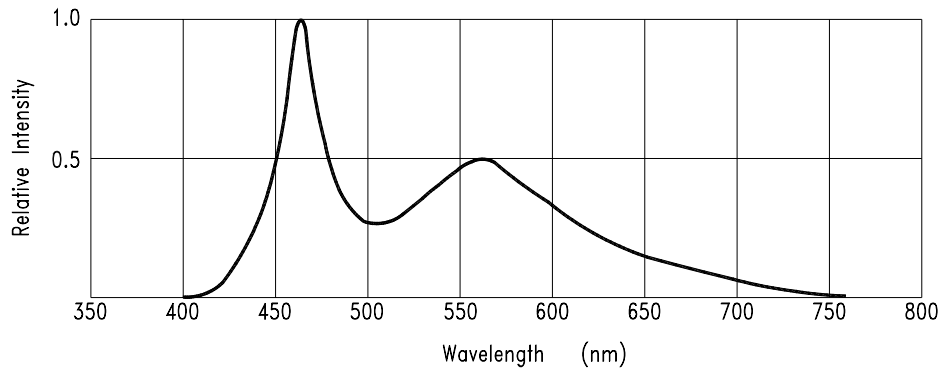

Fig.1 RELATIVE INTENSITY VS. WAVELENGTH

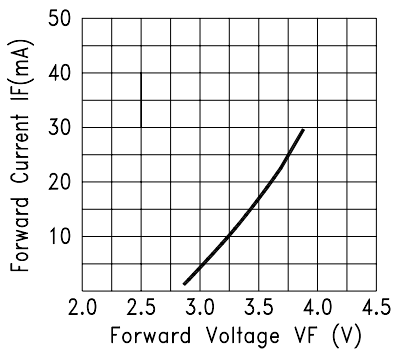

Fig.2 FORWARD CURRENT VS. FORWARD VOLTAGE

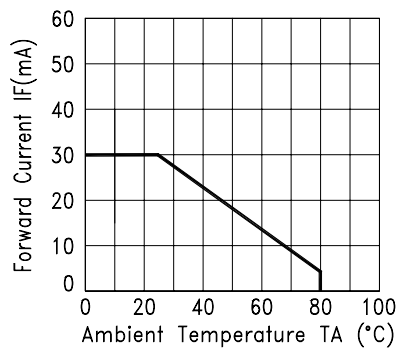

Fig.3 FORWARD CURRENT DERATING CURVE

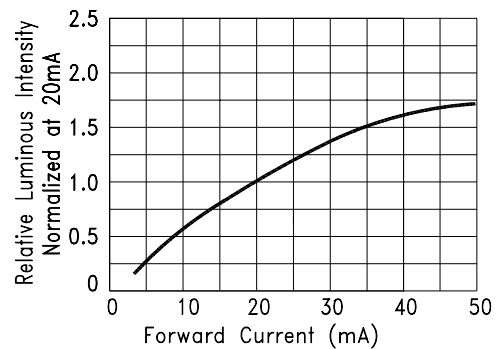

Fig.4 RELATIVE LUMINOUS INTENSITY VS. FORWARD CURRENT

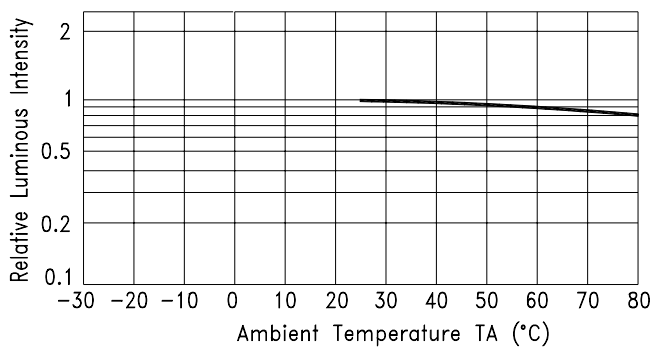

Fig.5 LUMINOUS INTENSITY VS. AMBIENT TEMPERATURE

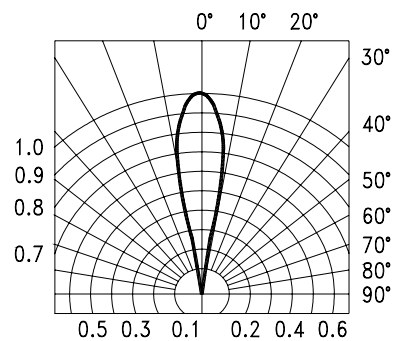

Fig.6 SPATIAL DISTRIBUTION

Property of Lite-On Only

Iv Spec. Table

Iv Bin	Luminous Intensity (mcd) If = 20mA	
	min.	max.
TU	2500	4200
VW	4200	7200

Hue Spec. Table

Hue Bin	Color bin limits at 20 mA					Approximate color temp. (K)
	CIE 1931 Chromaticity coordinates					
40	x	0.370	0.370	0.330	0.330	4200~5600
	y	0.450	0.350	0.300	0.400	
50	x	0.330	0.330	0.306	0.306	5600~7000
	y	0.400	0.300	0.269	0.369	
60	x	0.306	0.306	0.285	0.285	7000~9300
	y	0.369	0.269	0.244	0.344	
70	x	0.285	0.285	0.250	0.250	9300~20000
	y	0.344	0.244	0.200	0.300	

C.I.E. 1931 Chromaticity Diagram

