

10 9 8 7 6 5 4 3 2 1

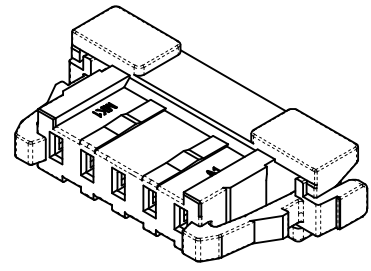

MATED CONDITION
[REFERENCE]

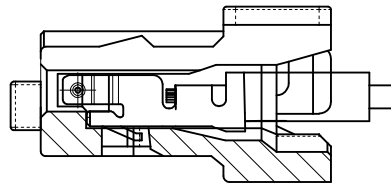
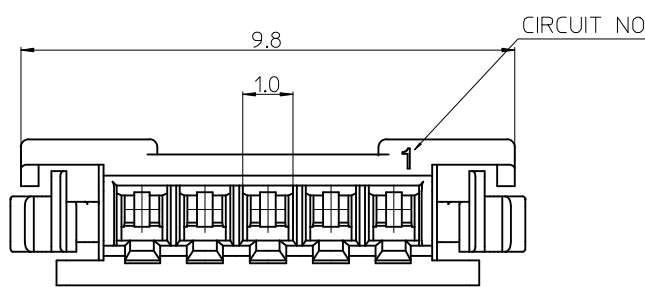
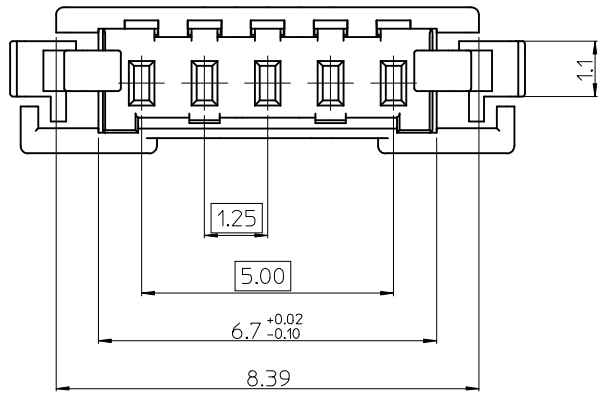
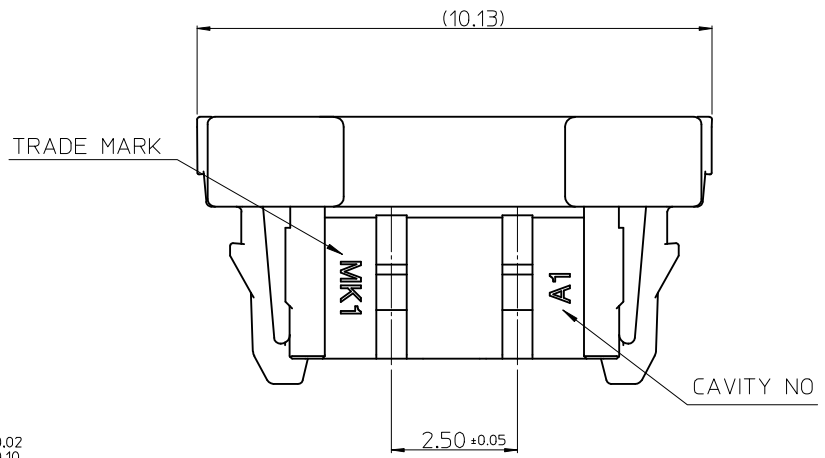
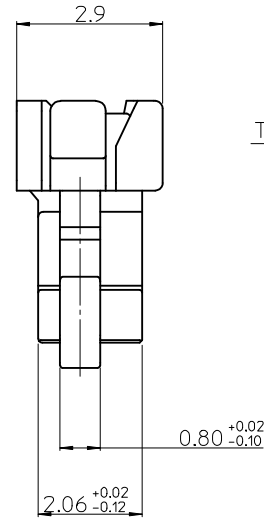
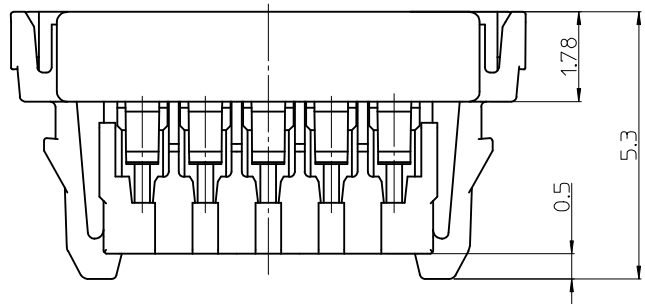

- NOTES.
1. MATED WITH : 104130-0510
 2. MATERIAL :
LCP E130i, GLASS FILLED, UL94V-0
HALOGEN FREE, COLOR OF NATURAL
 3. APPLICABLE TERMINAL : 104539-8102

ORDER NO 104131-0500

REVISED EC NO: KOR2017-0028 DRWN: SCHONG03 2016/11/23 CHKD: SHCHU 2016/11/23 APPR: YSKI M02 2016/11/29	QUALITY SYMBOLS ▽=0 ◻=0	GENERAL TOLERANCES (UNLESS SPECIFIED)		DIMENSION STYLE MM ONLY		SCALE 10:1	DESIGN UNITS METRIC	THIRD ANGLE PROJECTION		
			mm	INCH	DRAWN BY	DATE	TITLE			
		4 PLACES	± ---	± ---	JHPARK01	2011/12/20	1.25MM W-T-B CONN.5P HOUSING (POSITIVE LOCKING) molex			
		3 PLACES	± ---	± ---	CHECKED BY	DATE				
2 PLACES	± 0.15	± ---	SHCHU	2011/12/20	DOCUMENT NO. SD-104131-003					
1 PLACE	± 0.20	± ---	APPROVED BY	DATE	SHEET NO. 1 OF 1					
0 PLACE	± ---	± ---	YUNSIKKIM	2011/12/29	MATERIAL NO. 1041310500					
ANGULAR ± 1 °		DRAFT WHERE APPLICABLE MUST REMAIN WITHIN DIMENSIONS		THIS DRAWING CONTAINS INFORMATION THAT IS PROPRIETARY TO MOLEX INCORPORATED AND SHOULD NOT BE USED WITHOUT WRITTEN PERMISSION						

9 8 7 6 5 4 3 2 1