

1 2 3 4 5 6

A

B

C

D

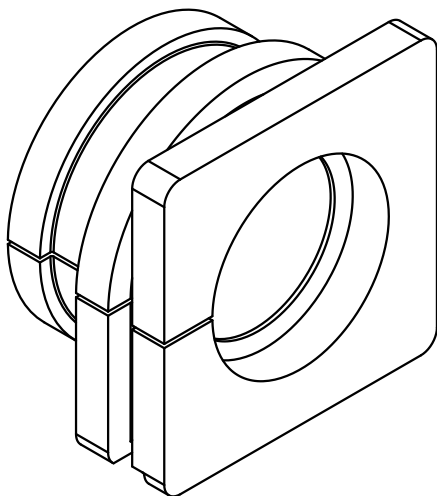
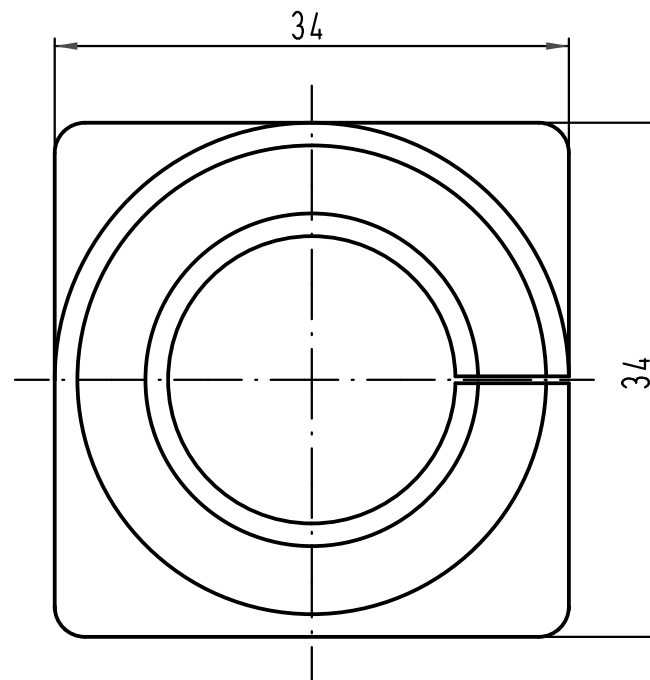
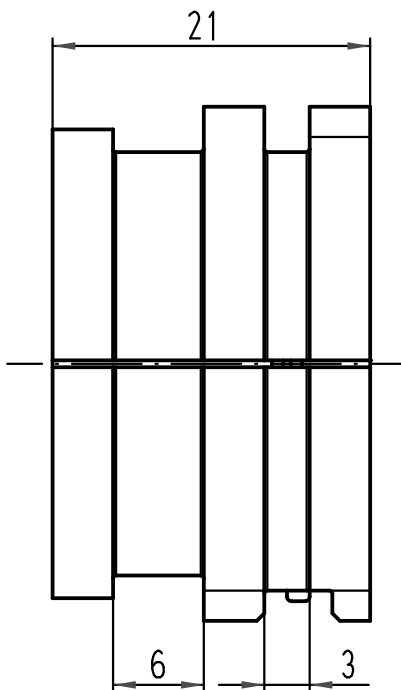

All Dimensions in mm Original Size DIN A 4			Techn. Character.			Nicht tolerierte Masse/ Free size tolerances		
				Dat.	Name	Massestab/ Scale 2:1	Durchführungsdichtung / Seal Han Power-S Ø19-22mm	
			Detail.	26.06.02	Pae			
			Insp.		Ole			
			Stand.					
412914	11.05.07	Ho	HARTING Electric GmbH & Co. KG				TB 09 12 000 9973	
410104			D-32339 Espelkamp					
Mod.	Dat.	Name					Blatt/ page	
						Sub.		