

# BCW68GL

## General Purpose Transistor

### PNP Silicon

#### Features

- NSV Prefix for Automotive and Other Applications Requiring Unique Site and Control Change Requirements; AEC-Q101 Qualified and PPAP Capable
- These Devices are Pb-Free, Halogen Free/BFR Free and are RoHS Compliant

#### MAXIMUM RATINGS

Rating	Symbol	Value	Unit
Collector-Emitter Voltage	$V_{CEO}$	-45	Vdc
Collector-Base Voltage	$V_{CBO}$	-60	Vdc
Emitter-Base Voltage	$V_{EBO}$	-5.0	Vdc
Collector Current – Continuous	$I_C$	-800	mAdc

Stresses exceeding those listed in the Maximum Ratings table may damage the device. If any of these limits are exceeded, device functionality should not be assumed, damage may occur and reliability may be affected.

#### THERMAL CHARACTERISTICS

Characteristic	Symbol	Max	Unit
Total Device Dissipation FR-5 Board (Note 1) $T_A = 25^\circ\text{C}$ Derate above $25^\circ\text{C}$	$P_D$	225	mW
		1.8	mW/ $^\circ\text{C}$
Thermal Resistance, Junction-to-Ambient	$R_{\theta JA}$	556	$^\circ\text{C}/\text{W}$
Total Device Dissipation Alumina Substrate (Note 2) $T_A = 25^\circ\text{C}$ Derate above $25^\circ\text{C}$	$P_D$	300	mW
		2.4	mW/ $^\circ\text{C}$
Thermal Resistance, Junction-to-Ambient	$R_{\theta JA}$	417	$^\circ\text{C}/\text{W}$
Junction and Storage Temperature	$T_J, T_{stg}$	-55 to +150	$^\circ\text{C}$

1. FR-5 =  $1.0 \times 0.75 \times 0.062$  in.
2. Alumina =  $0.4 \times 0.3 \times 0.024$  in 99.5% alumina.



ON Semiconductor®

[www.onsemi.com](http://www.onsemi.com)

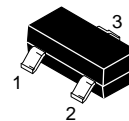
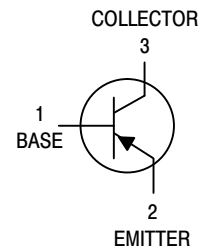

SOT-23  
CASE 318  
STYLE 6

#### MARKING DIAGRAM

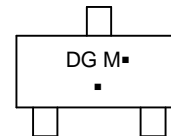

DG = Specific Device Code  
M = Date Code\*  
▪ = Pb-Free Package

(Note: Microdot may be in either location)

\*Date Code orientation and/or overbar may vary depending upon manufacturing location.

#### ORDERING INFORMATION

Device	Package	Shipping†
BCW68GLT1G, NSVBCW68GLT1G	SOT-23 (Pb-Free)	3000 / Tape & Reel
BCW68GLT3G	SOT-23 (Pb-Free)	10000 / Tape & Reel

†For information on tape and reel specifications, including part orientation and tape sizes, please refer to our Tape and Reel Packaging Specifications Brochure, BRD8011/D.

# BCW68GL

## ELECTRICAL CHARACTERISTICS ( $T_A = 25^\circ\text{C}$ unless otherwise noted)

Characteristic	Symbol	Min	Typ	Max	Unit
<b>OFF CHARACTERISTICS</b>					
Collector-Emitter Breakdown Voltage ( $I_C = -10\text{ mAdc}$ , $I_B = 0$ )	$V_{(BR)CEO}$	-45	-	-	Vdc
Collector-Emitter Breakdown Voltage ( $I_C = -10\ \mu\text{Adc}$ , $V_{EB} = 0$ )	$V_{(BR)CES}$	-60	-	-	Vdc
Emitter-Base Breakdown Voltage ( $I_E = -10\ \mu\text{Adc}$ , $I_C = 0$ )	$V_{(BR)EBO}$	-5.0	-	-	Vdc
Collector Cutoff Current ( $V_{CE} = -45\text{ Vdc}$ , $I_E = 0$ ) ( $V_{CE} = -45\text{ Vdc}$ , $I_B = 0$ , $T_A = 150^\circ\text{C}$ )	$I_{CES}$	-	-	-20 -10	nAdc $\mu\text{Adc}$
Emitter Cutoff Current ( $V_{EB} = -4.0\text{ Vdc}$ , $I_C = 0$ )	$I_{EBO}$	-	-	-20	nAdc
<b>ON CHARACTERISTICS</b>					
DC Current Gain ( $I_C = -10\text{ mAdc}$ , $V_{CE} = -1.0\text{ Vdc}$ ) ( $I_C = -100\text{ mAdc}$ , $V_{CE} = -1.0\text{ Vdc}$ ) ( $I_C = -300\text{ mAdc}$ , $V_{CE} = -1.0\text{ Vdc}$ )	$h_{FE}$	120 160 60	- - -	400 - -	-
Collector-Emitter Saturation Voltage ( $I_C = -500\text{ mAdc}$ , $I_B = -50\text{ mAdc}$ )	$V_{CE(sat)}$	-	-	-0.7	Vdc
Base-Emitter Saturation Voltage ( $I_C = -500\text{ mAdc}$ , $I_B = -50\text{ mAdc}$ )	$V_{BE(sat)}$	-	-	-2.0	Vdc
<b>SMALL-SIGNAL CHARACTERISTICS</b>					
Current-Gain – Bandwidth Product ( $I_C = -20\text{ mAdc}$ , $V_{CE} = -10\text{ Vdc}$ , $f = 100\text{ MHz}$ )	$f_T$	100	-	-	MHz
Output Capacitance ( $V_{CB} = -10\text{ Vdc}$ , $I_E = 0$ , $f = 1.0\text{ MHz}$ )	$C_{obo}$	-	-	18	pF
Input Capacitance ( $V_{EB} = -0.5\text{ Vdc}$ , $I_C = 0$ , $f = 1.0\text{ MHz}$ )	$C_{ibo}$	-	-	105	pF
Noise Figure ( $I_C = -0.2\text{ mAdc}$ , $V_{CE} = -5.0\text{ Vdc}$ , $R_S = 1.0\text{ k}\Omega$ , $f = 1.0\text{ kHz}$ , $BW = 200\text{ Hz}$ )	$N_F$	-	-	10	dB

Product parametric performance is indicated in the Electrical Characteristics for the listed test conditions, unless otherwise noted. Product performance may not be indicated by the Electrical Characteristics if operated under different conditions.

TYPICAL CHARACTERISTICS

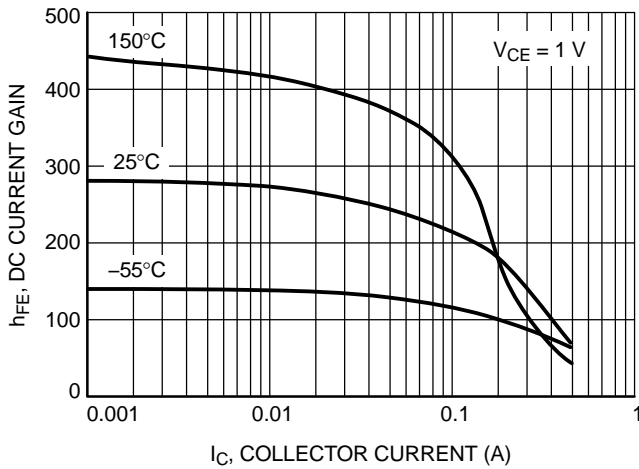

Figure 1. DC Current Gain vs. Collector Current

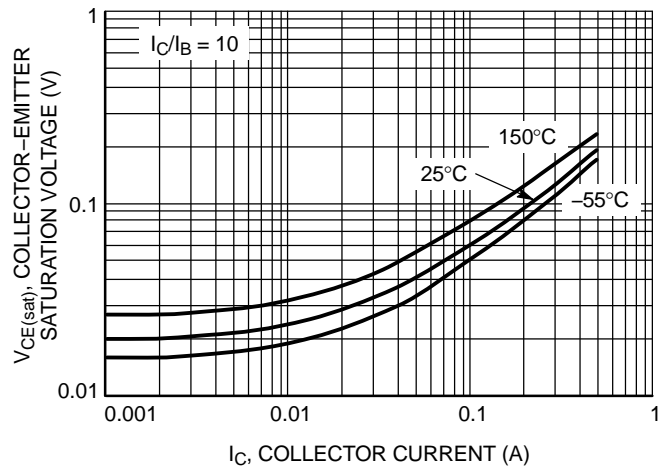

Figure 2. Collector Emitter Saturation Voltage vs. Collector Current

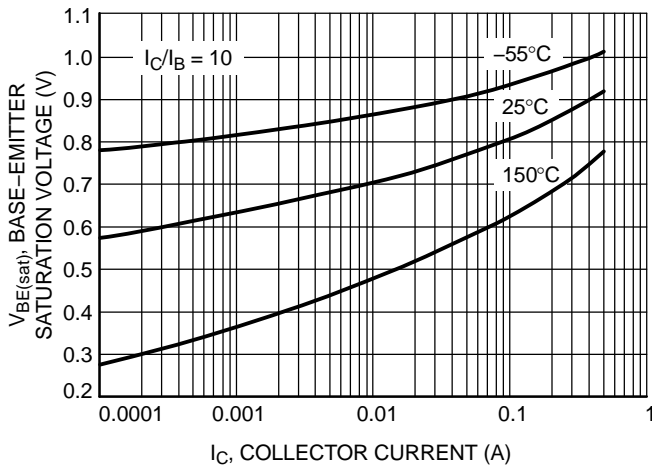

Figure 3. Base Emitter Saturation Voltage vs. Collector Current

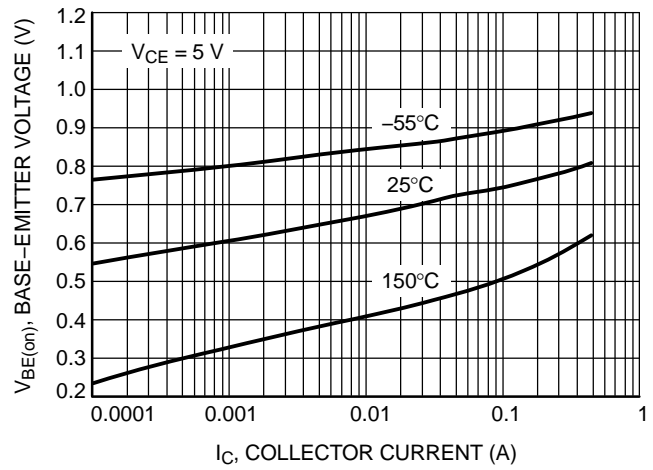

Figure 4. Base Emitter Voltage vs. Collector Current

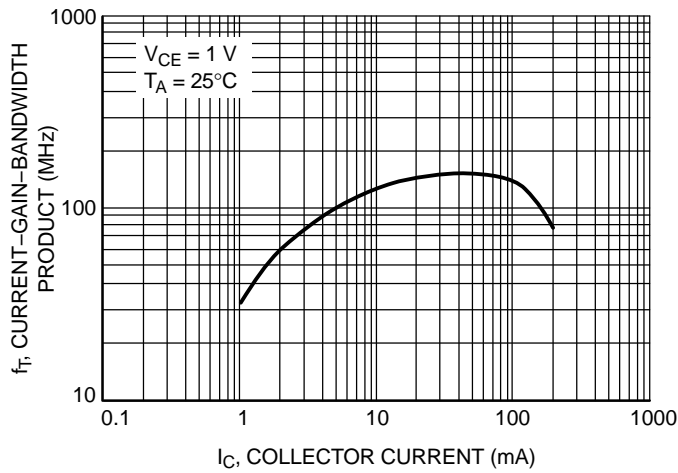

Figure 5. Current Gain Bandwidth Product vs. Collector Current

# BCW68GL

## TYPICAL CHARACTERISTICS

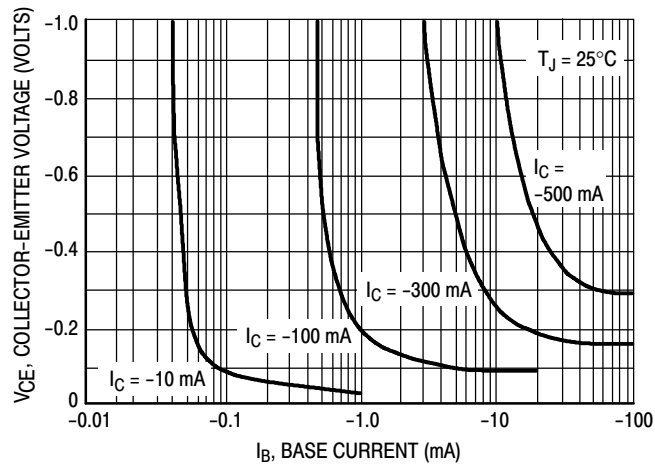

Figure 6. Saturation Region

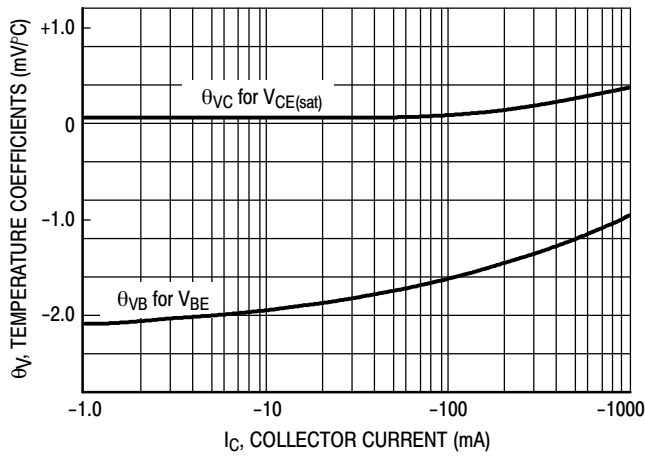

Figure 7. Temperature Coefficients

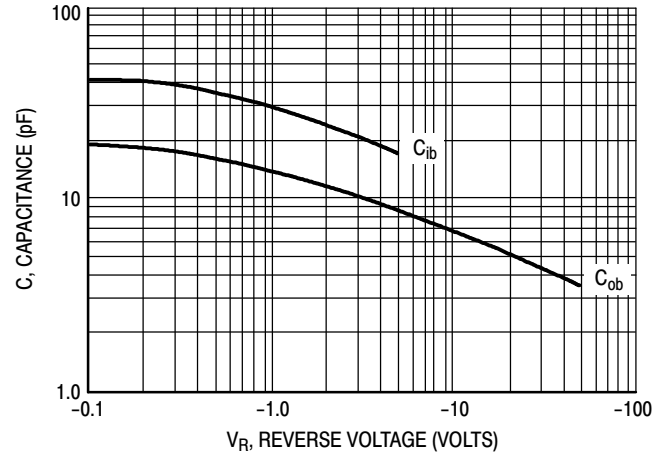
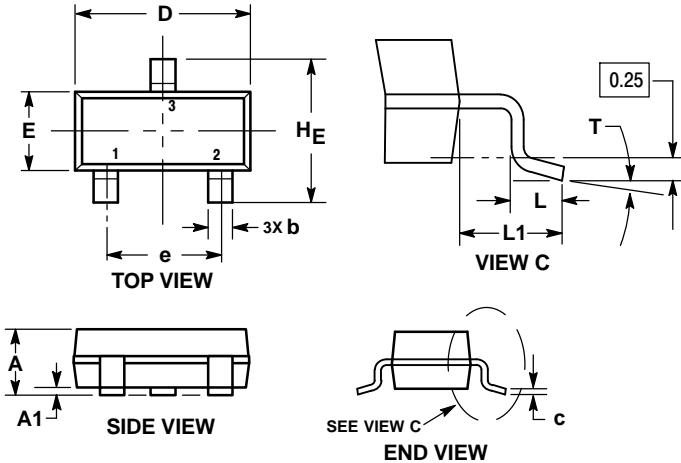

Figure 8. Capacitances

# BCW68GL

## PACKAGE DIMENSIONS

SOT-23 (TO-236)  
CASE 318-08  
ISSUE AR



NOTES:

1. DIMENSIONING AND TOLERANCING PER ASME Y14.5M, 1994.
2. CONTROLLING DIMENSION: MILLIMETERS.
3. MAXIMUM LEAD THICKNESS INCLUDES LEAD FINISH. MINIMUM LEAD THICKNESS IS THE MINIMUM THICKNESS OF THE BASE MATERIAL.
4. DIMENSIONS D AND E DO NOT INCLUDE MOLD FLASH, PROTRUSIONS, OR GATE BURRS.

DIM	MILLIMETERS			INCHES		
	MIN	NOM	MAX	MIN	NOM	MAX
A	0.89	1.00	1.11	0.035	0.039	0.044
A1	0.01	0.06	0.10	0.000	0.002	0.004
b	0.37	0.44	0.50	0.015	0.017	0.020
c	0.08	0.14	0.20	0.003	0.006	0.008
D	2.80	2.90	3.04	0.110	0.114	0.120
E	1.20	1.30	1.40	0.047	0.051	0.055
e	1.78	1.90	2.04	0.070	0.075	0.080
L	0.30	0.43	0.55	0.012	0.017	0.022
L1	0.35	0.54	0.69	0.014	0.021	0.027
HE	2.10	2.40	2.64	0.083	0.094	0.104
T	0°	---	10°	0°	---	10°

STYLE 6:

1. BASE
2. EMITTER
3. COLLECTOR

### RECOMMENDED SOLDERING FOOTPRINT\*

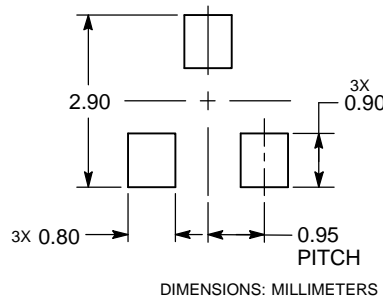

\*For additional information on our Pb-Free strategy and soldering details, please download the ON Semiconductor Soldering and Mounting Techniques Reference Manual, SOLDERRM/D.

ON Semiconductor and are trademarks of Semiconductor Components Industries, LLC dba ON Semiconductor or its subsidiaries in the United States and/or other countries. ON Semiconductor owns the rights to a number of patents, trademarks, copyrights, trade secrets, and other intellectual property. A listing of ON Semiconductor's product/patent coverage may be accessed at [www.onsemi.com/site/pdf/Patent-Marking.pdf](http://www.onsemi.com/site/pdf/Patent-Marking.pdf). ON Semiconductor reserves the right to make changes without further notice to any products herein. ON Semiconductor makes no warranty, representation or guarantee regarding the suitability of its products for any particular purpose, nor does ON Semiconductor assume any liability arising out of the application or use of any product or circuit, and specifically disclaims any and all liability, including without limitation special, consequential or incidental damages. Buyer is responsible for its products and applications using ON Semiconductor products, including compliance with all laws, regulations and safety requirements or standards, regardless of any support or applications information provided by ON Semiconductor. "Typical" parameters which may be provided in ON Semiconductor data sheets and/or specifications can and do vary in different applications and actual performance may vary over time. All operating parameters, including "Typicals" must be validated for each customer application by customer's technical experts. ON Semiconductor does not convey any license under its patent rights nor the rights of others. ON Semiconductor products are not designed, intended, or authorized for use as a critical component in life support systems or any FDA Class 3 medical devices or medical devices with a same or similar classification in a foreign jurisdiction or any devices intended for implantation in the human body. Should Buyer purchase or use ON Semiconductor products for any such unintended or unauthorized application, Buyer shall indemnify and hold ON Semiconductor and its officers, employees, subsidiaries, affiliates, and distributors harmless against all claims, costs, damages, and expenses, and reasonable attorney fees arising out of, directly or indirectly, any claim of personal injury or death associated with such unintended or unauthorized use, even if such claim alleges that ON Semiconductor was negligent regarding the design or manufacture of the part. ON Semiconductor is an Equal Opportunity/Affirmative Action Employer. This literature is subject to all applicable copyright laws and is not for resale in any manner.

### PUBLICATION ORDERING INFORMATION

**LITERATURE FULFILLMENT:**  
Literature Distribution Center for ON Semiconductor  
19521 E. 32nd Pkwy, Aurora, Colorado 80011 USA  
**Phone:** 303-675-2175 or 800-344-3860 Toll Free USA/Canada  
**Fax:** 303-675-2176 or 800-344-3867 Toll Free USA/Canada  
**Email:** [orderlit@onsemi.com](mailto:orderlit@onsemi.com)

**N. American Technical Support:** 800-282-9855 Toll Free  
USA/Canada  
**Europe, Middle East and Africa Technical Support:**  
Phone: 421 33 790 2910  
**Japan Customer Focus Center**  
Phone: 81-3-5817-1050

**ON Semiconductor Website:** [www.onsemi.com](http://www.onsemi.com)  
**Order Literature:** <http://www.onsemi.com/orderlit>

For additional information, please contact your local Sales Representative