

PXE30xxSxx Single Output DC/DC Converters

9 to 18 Vdc, 18 to 36 Vdc, or 36 to 75 Vdc input, 1.5 to 15 Vdc Single Output, 30W



APPLICATIONS

Wireless Network
Telecom/Datacom
Industry Control System
Measurement Equipment
Semiconductor Equipment

Features

- 30 watts maximum output power
- Output current up to 6A
- Standard 2" x 1.6" x 0.4" package
- High efficiency up to 90%
- 2:1 wide input voltage range
- Six-sided continuous shield
- Fixed switching frequency
- Offer single output
- CE MARK meets 2006/95/EC, 93/68/EEC and 2004/108/EC
- UL60950-1, EN60950-1 and IEC60950-1 licensed
- Iso9001 certified manufacturing facilities
- Compliant to ROHS EU directive 2002/95/EC

Options

- Heat sinks available for extended operation

General Description

The PXE30xxSxx series offers 30 watts of output power from a 2 x 1.6 x 0.4 inch package. It has a 2:1 wide input voltage range of 9-18VDC, 18-36VDC and 36-75VDC and features 1600VDC of isolation, short-circuit and over-voltage protection.

Table of Contents

Absolute Maximum Rating	P2	Heat Sink Consideration	P53
Output Specification	P2	Remote ON/OFF Control	P54
Input Specification	P3	Mechanical Data	P55
General Specification	P5	Recommended Pad Layout	P56
Characteristic Curves	P6	Output Voltage Adjustment	P57
Test Configurations	P48	Soldering and Reflow Consideration	P59
EMC Considerations	P49	Packaging Information	P59
Input Source Impedance	P51	Part Number Structure	P60
Output Over Current Protection	P51	Safety and Installation Instruction	P61
Output Over Voltage Protection	P52	MTBF and Reliability	P61
Short Circuit Protection	P52		
Thermal Consideration	P52		

Absolute Maximum Rating					
Parameter	Model	Min	Max	Unit	
Input Voltage Continuous	12Sxx		18	V _{DC}	
	24Sxx		36		
	48Sxx		75		
	Transient (100mS)	12Sxx			36
		24Sxx			50
		48Sxx			100
Input Voltage Variation (complies with EST300 132 part 4.4)	All		5	V/mS	
Operating Ambient Temperature (with derating)	All	-40	85	°C	
Operating Case Temperature	All		100	°C	
Storage Temperature	All	-55	105	°C	

Output Specification					
Parameter	Model	Min	Typ	Max	Unit
Output Voltage (V _{in} = V _{in} (nom) ; Full Load ; T _A =25°C)	xxS1P5	1.485	1.5	1.515	V _{DC}
	xxS1P8	1.782	1.8	1.818	
	xxS2P5	2.475	2.5	2.525	
	xxS3P3	3.267	3.3	3.333	
	xxS05	4.95	5	5.05	
	xxS12	11.88	12	12.12	
	xxS15	14.85	15	15.15	
Voltage Adjustability	All	-10		+10	%
Output Regulation Line (V _{in} (min) to V _{in} (max) at Full Load) Load (Min. to 100% of Full Load)	All	-0.2		+0.2	%
		-0.5		+0.5	
Output Ripple & Noise Peak-to-Peak (20MHz bandwidth) (Measured with a 0.1µF/50V MLCC)	xxS1P5		50		mVp-p
	xxS1P8		50		
	xxS2P5		50		
	xxS3P3		50		
	xxS05		50		
	xxS12		75		
	xxS15		75		
Temperature Coefficient	All	-0.02		+0.02	%/°C
Output Voltage Overshoot (V _{in} (min) to V _{in} (max) ; Full Load ; T _A =25°C)	All		0	5	% V _{OUT}
Dynamic Load Response (V _{in} = V _{in} (nom) ; T _A =25°C) Load step change from 75% to 100% or 100 to 75% of Full Load Peak Deviation Setting Time (V _{OUT} -10% peak deviation)	All		250		mV µS
	All		300		
Output Current	xxS1P5	0		6000	mA
	xxS1P8	0		6000	
	xxS2P5	0		6000	
	xxS3P3	0		6000	
	xxS05	0		6000	
	xxS12	0		2500	
	xxS15	0		2000	

Output Specification(Continued)					
Parameter	Model	Min	Typ	Max	Unit
Output Over Voltage Protection (Zener diode clamp)	xxS1P5		3.9		V _{DC}
	xxS1P8		3.9		
	xxS2P5		3.9		
	xxS3P3		3.9		
	xxS05		6.2		
	xxS12		15		
	xxS15		18		
Output Over Current Protection	All			150	% FL.
Output Short Circuit Protection	All	Hiccup, automatic recovery			

Input Specification					
Parameter	Model	Min	Typ	Max	Unit
Operating Input Voltage	12Sxx	9	12	18	V _{DC}
	24Sxx	18	24	36	
	48Sxx	36	48	75	
Input Current (Maximum value at V _{in} = V _{in} (nom); Full Load)	12S1P5			1014	mA
	12S1P8			1169	
	12S2P5			1582	
	12S3P3			2037	
	12S05			3012	
	12S12			2976	
	12S15			2976	
	24S1P5			439	
	24S1P8			580	
	24S2P5			780	
	24S3P3			1010	
	24S05			1490	
	24S12			1470	
	24S15			1470	
	48S1P5			244	
	48S1P8			290	
	48S2P5			390	
48S3P3			500		
48S05			740		
48S12			730		
48S15			730		

Input Specification (Continued)					
Parameter	Model	Min	Typ	Max	Unit
Input Standby Current (Typical value at $V_{in} = V_{in(nom)}$; No Load)	12S1P5		100		mA
	12S1P8		100		
	12S2P5		110		
	12S3P3		115		
	12S05		95		
	12S12		170		
	12S15		210		
	24S1P5		50		
	24S1P8		35		
	24S2P5		45		
	24S3P3		50		
	24S05		50		
	24S12		80		
	24S15		90		
	48S1P5		20		
	48S1P8		20		
	48S2P5		25		
	48S3P3		30		
	48S05		35		
48S12		35			
48S15		55			
Under Voltage Lockout Turn-on Threshold	12Sxx			9	V_{DC}
	24Sxx			17.8	
	48Sxx			36	
Under Voltage Lockout Turn-off Threshold	12Sxx		8		V_{DC}
	24Sxx		16		
	48Sxx		33		
Input Reflected Ripple Current (5 to 20MHz, 12 μ H Source Impedance)	All		30		mAp-p
Start Up Time ($V_{in} = V_{in(nom)}$ and Constant Resistive Load)	All			25	mS
Remote ON/OFF Control (The ON/OFF pin voltage is referenced to $-V_{IN}$)	All	3.0		12	VDC
Positive Logic DC-DC ON					
DC-DC OFF		0		1.2	
Remote Off Input Current	All		2.5		mA
Input Current of Remote Control Pin	All	-0.5		0.5	mA

General Specification					
Parameter	Model	Min	Typ	Max	Unit
Efficiency ($V_{in} = V_{in(nom)}$; Full Load ; $T_A=25^{\circ}C$)	12S1P5		78		%
	12S1P8		81		
	12S2P5		83		
	12S3P3		85		
	12S05		87		
	12S12		88		
	12S15		88		
	24S1P5		80		
	24S1P8		82		
	24S2P5		84		
	24S3P3		86		
	24S05		88		
	24S12		89		
	24S15		89		
	48S1P5		81		
	48S1P8		83		
	48S2P5		85		
	48S3P3		87		
	48S05		89		
48S12		90			
48S15		90			
Isolation Voltage Input to Output Input to Case, Output to Case	All	1600 1600			V_{DC}
Isolation Resistance	All	1			$G\Omega$
Isolation Capacitance	All			1000	pF
Switching Frequency	All		300		KHz
Weight	All		48		g
MTBF Bellcore TR-NWT-000332, $T_C=40^{\circ}C$ MIL-HDBK-217F	All		1.316×10^6 3.465×10^5		Hours
Over Temperature Protection	All		115		$^{\circ}C$

Characteristic Curves

All test conditions are at 25°C. The figures are for PXE30-12S1P5

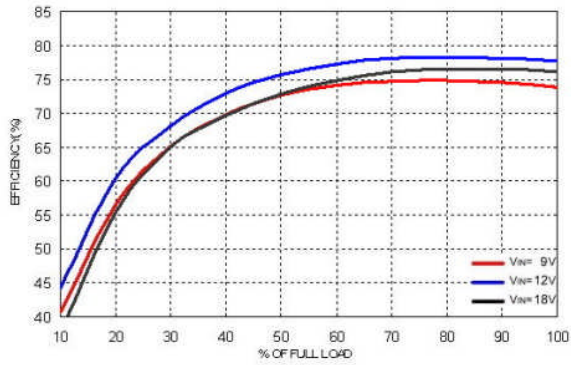

Efficiency Versus Output Current

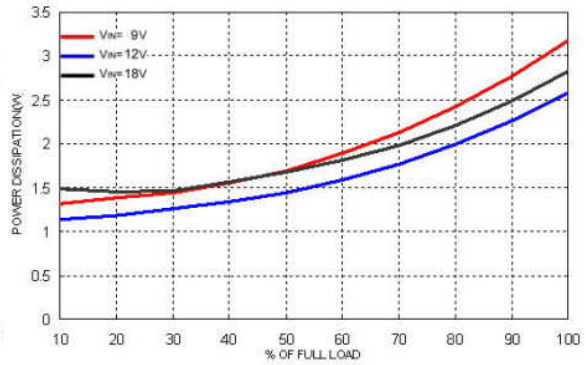

Power Dissipation Versus Output Current

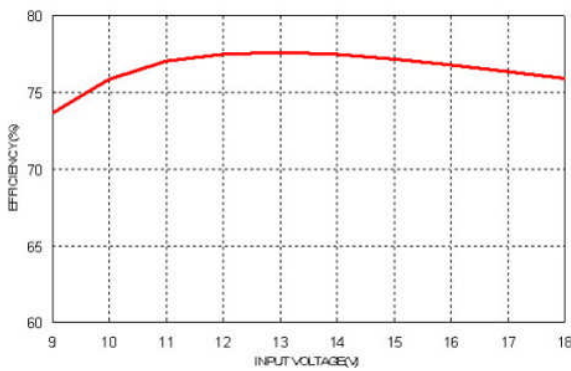

Efficiency Versus Input Voltage. Full Load

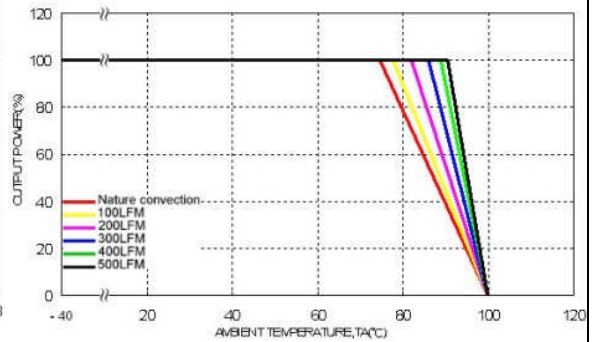

Derating Output Current Versus Ambient Temperature and Airflow
Vin=Vin(nom)

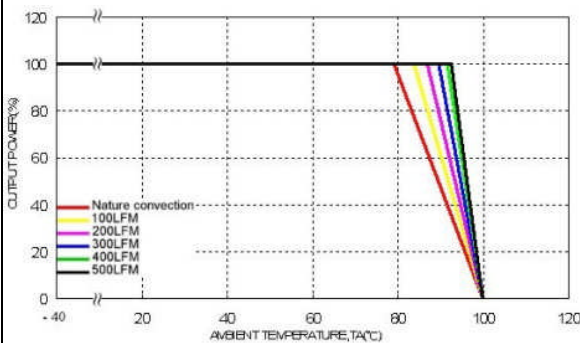

Derating Output Current Versus Ambient Temperature with Heat-Sink
and Airflow, Vin = Vin(nom)

Characteristic Curves (Continued)

All test conditions are at 25°C. The figures are for PXE30-12S1P5

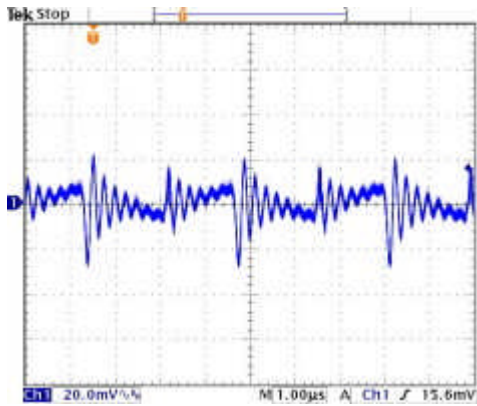

Typical Output Ripple and Noise.
Vin=Vin(nom), Full Load

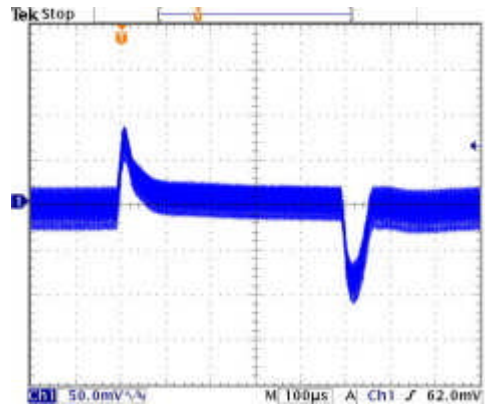

Transient Response to Dynamic Load Change from 100% to 75% to 100% of Full Load ; Vin=Vin(nom)

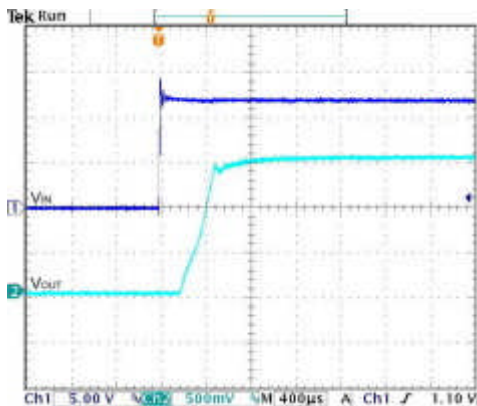

Typical Input Start-Up and Output Rise Characteristic
Vin=Vin(nom), Full Load

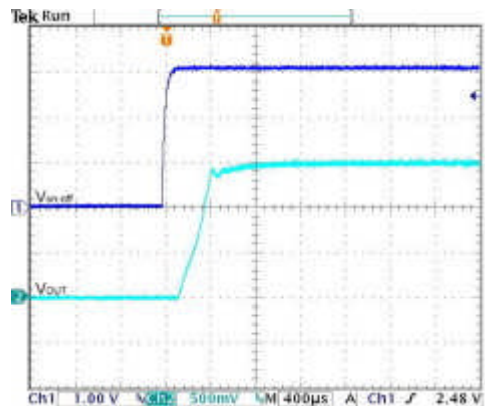

Using ON/OFF Voltage Start-Up and Vo Rise Characteristic
Vin=Vin(nom), Full Load

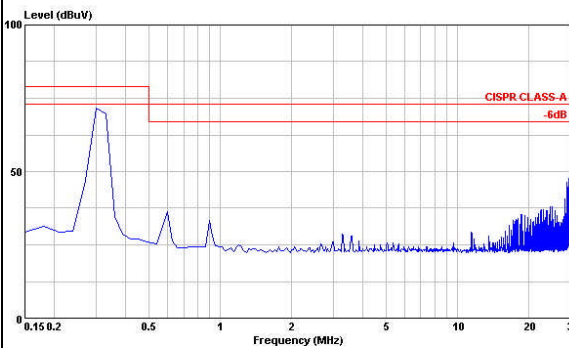

Conduction Emission of EN55022 Class A
Vin=Vin(nom), Full Load

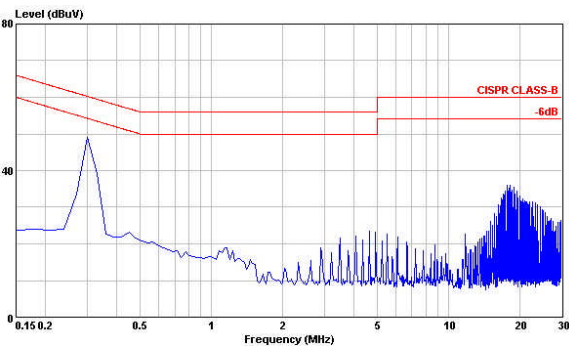

Conduction Emission of EN55022 Class B
Vin=Vin(nom), Full Load

Characteristic Curves (Continued)

All test conditions are at 25°C. The figures are for PXE30-12S1P8

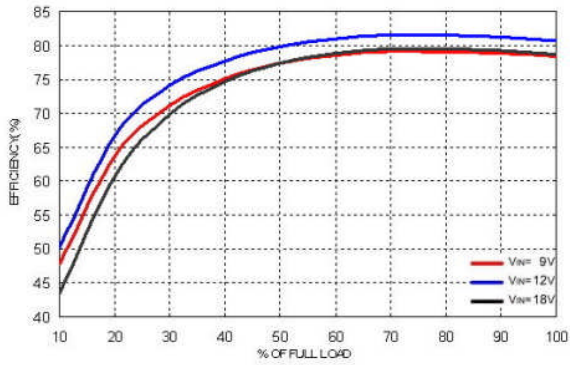

Efficiency Versus Output Current

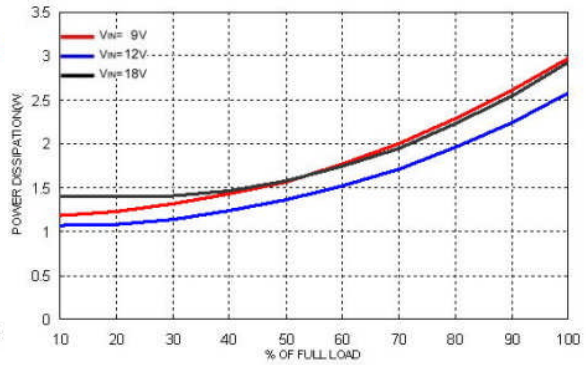

Power Dissipation Versus Output Current

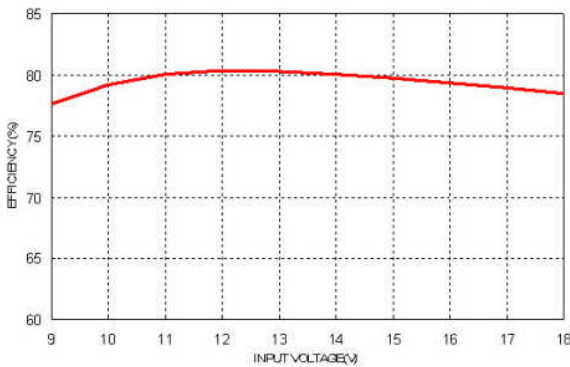

Efficiency Versus Input Voltage. Full Load

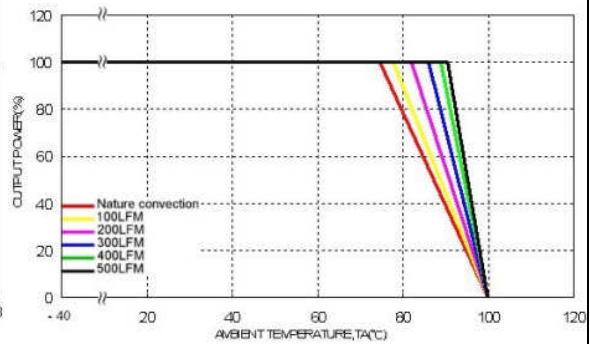

Derating Output Current Versus Ambient Temperature and Airflow
Vin=Vin(nom)

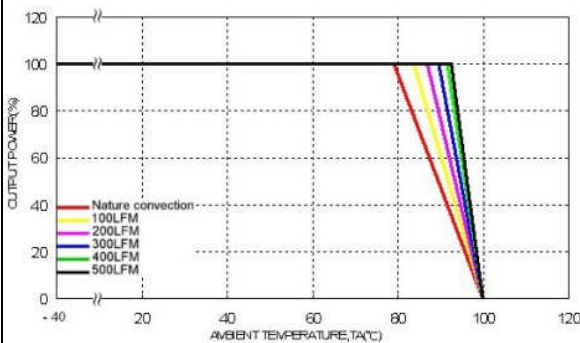

Derating Output Current Versus Ambient Temperature with Heat-Sink
and Airflow, Vin = Vin(nom)

Characteristic Curves (Continued)

All test conditions are at 25°C. The figures are for PXE30-12S1P8

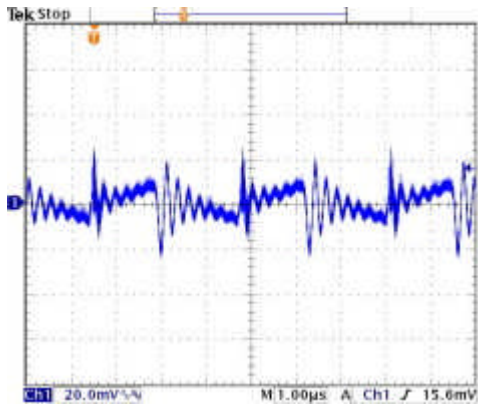

Typical Output Ripple and Noise.
Vin=Vin(nom), Full Load

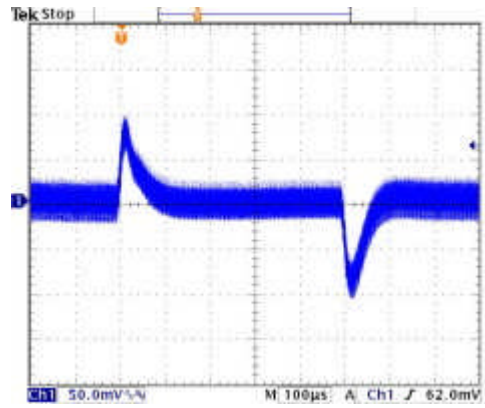

Transient Response to Dynamic Load Change from 100% to 75% to 100% of Full Load ; Vin=Vin(nom)

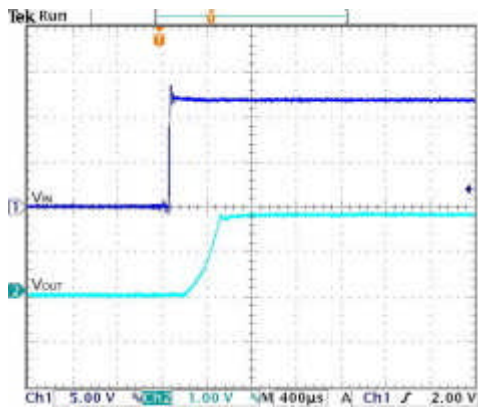

Typical Input Start-Up and Output Rise Characteristic
Vin=Vin(nom), Full Load

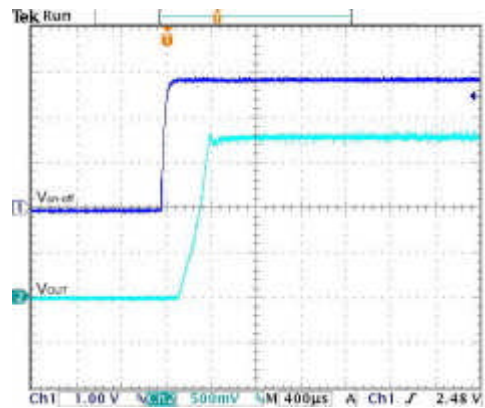

Using ON/OFF Voltage Start-Up and Vo Rise Characteristic
Vin=Vin(nom), Full Load

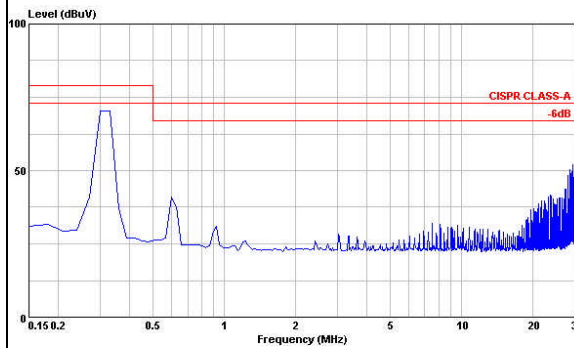

Conduction Emission of EN55022 Class A
Vin=Vin(nom), Full Load

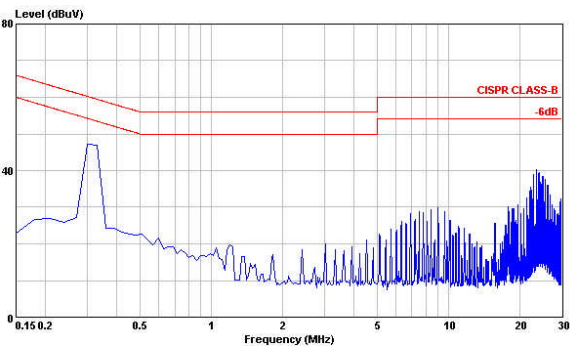

Conduction Emission of EN55022 Class B
Vin=Vin(nom), Full Load

Characteristic Curves (Continued)

All test conditions are at 25°C. The figures are for PXE30-12S2P5

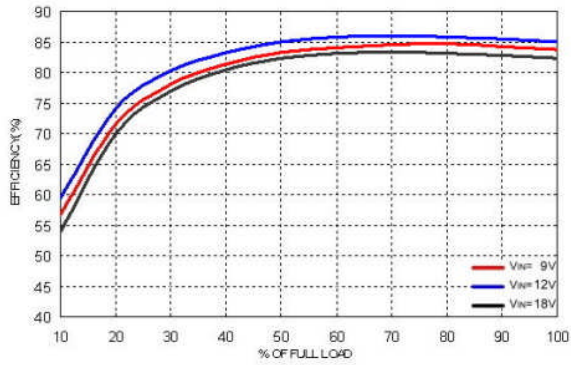

Efficiency Versus Output Current

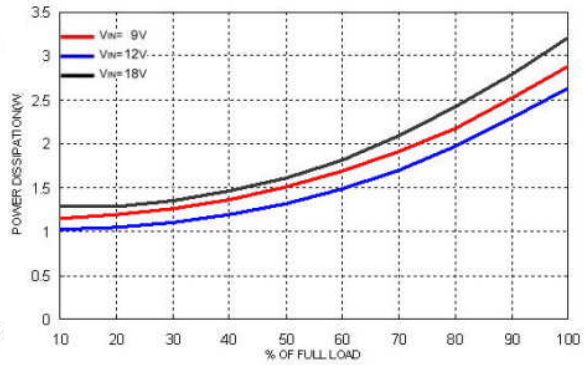

Power Dissipation Versus Output Current

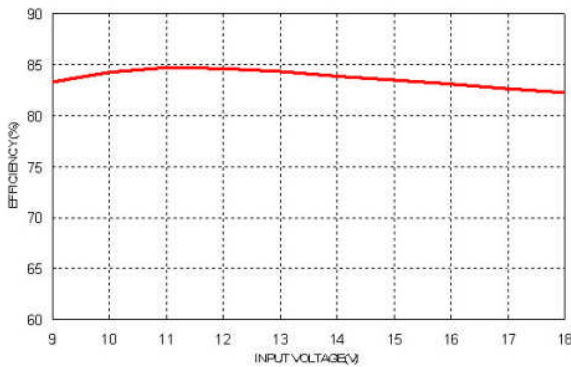

Efficiency Versus Input Voltage. Full Load

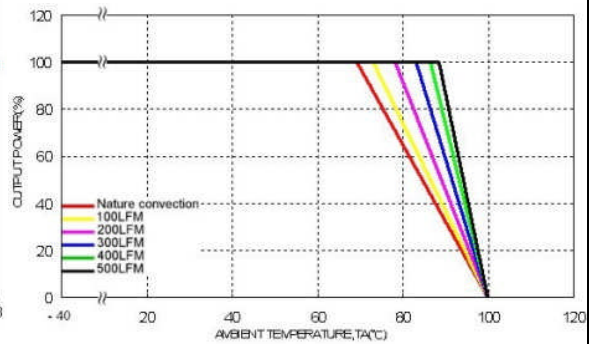

Derating Output Current Versus Ambient Temperature and Airflow
Vin=Vin(nom)

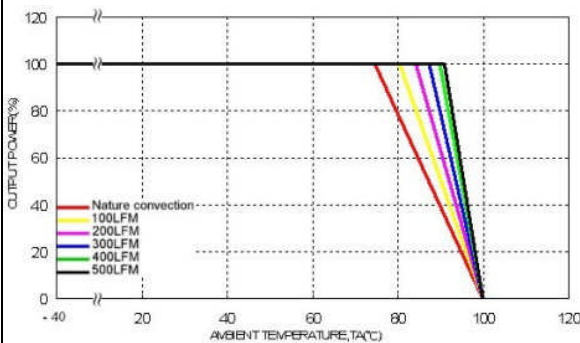

Derating Output Current Versus Ambient Temperature with Heat-Sink
and Airflow, Vin = Vin(nom)

Characteristic Curves (Continued)

All test conditions are at 25°C. The figures are for PXE30-12S2P5

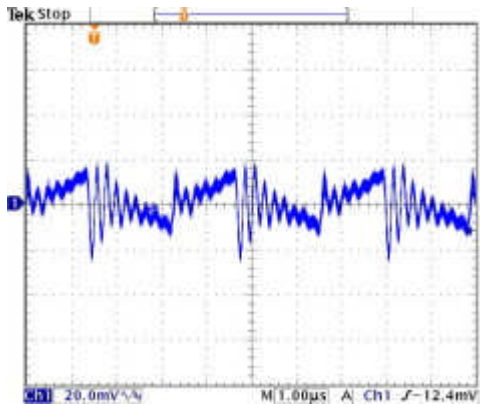

Typical Output Ripple and Noise.
Vin=Vin(nom), Full Load

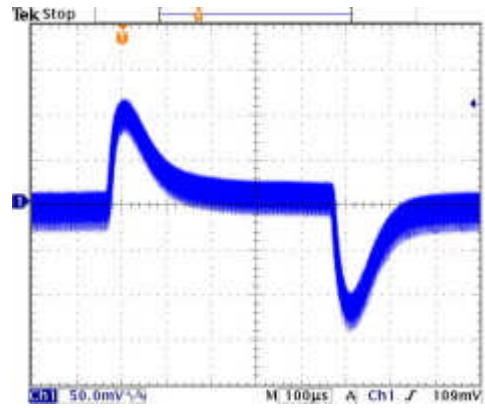

Transient Response to Dynamic Load Change from 100% to 75% to 100% of Full Load ; Vin=Vin(nom)

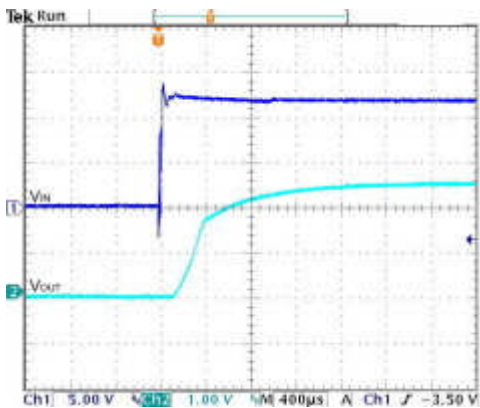

Typical Input Start-Up and Output Rise Characteristic
Vin=Vin(nom), Full Load

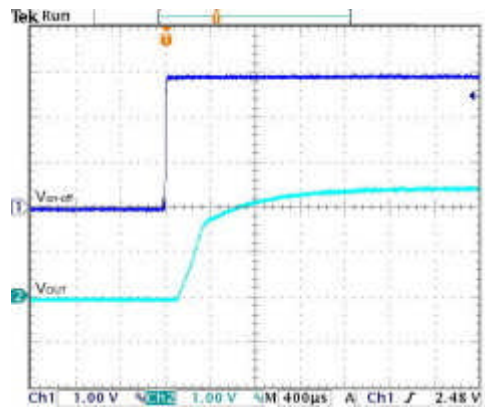

Using ON/OFF Voltage Start-Up and Vo Rise Characteristic
Vin=Vin(nom), Full Load

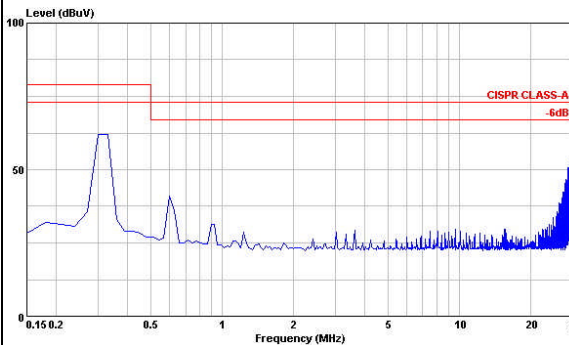

Conduction Emission of EN55022 Class A
Vin=Vin(nom), Full Load

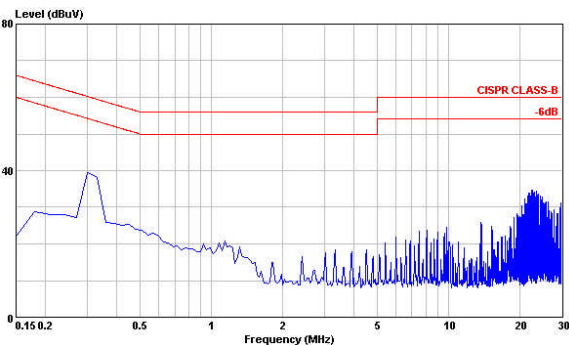

Conduction Emission of EN55022 Class B
Vin=Vin(nom), Full Load

Characteristic Curves (Continued)

All test conditions are at 25°C. The figures are for PXE30-12S3P3

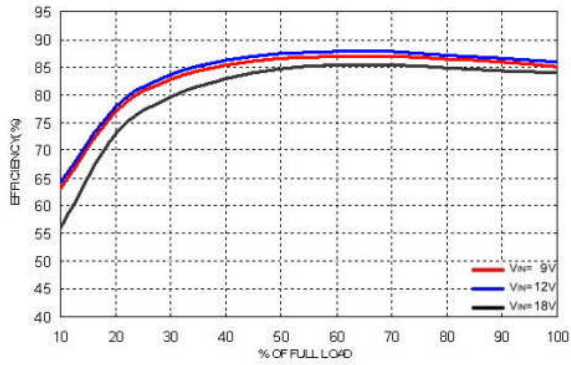

Efficiency Versus Output Current

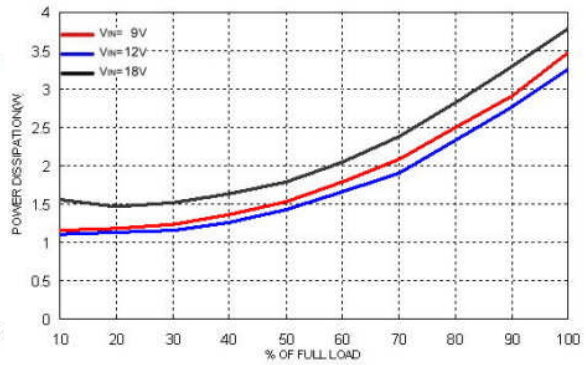

Power Dissipation Versus Output Current

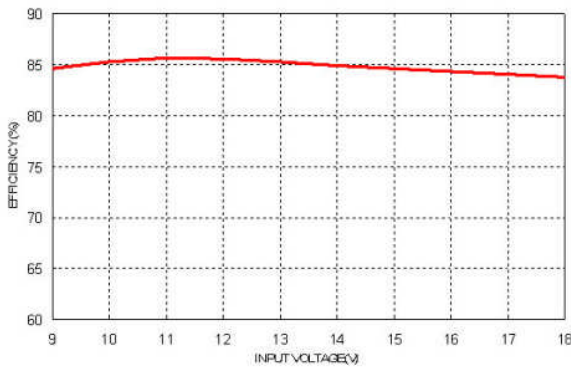

Efficiency Versus Input Voltage. Full Load

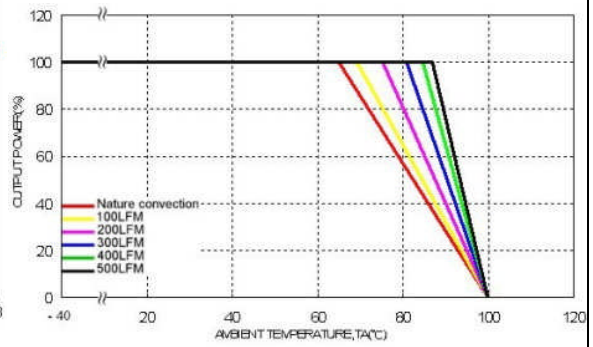

Derating Output Current Versus Ambient Temperature and Airflow
Vin=Vin(nom)

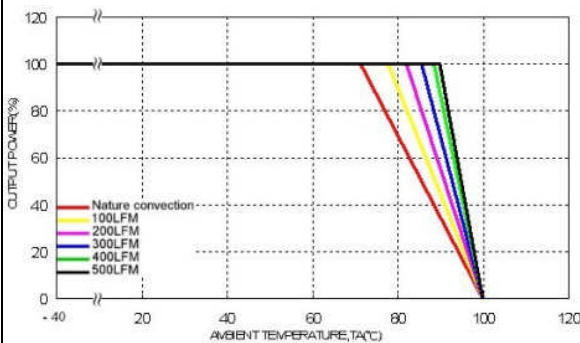

Derating Output Current Versus Ambient Temperature with Heat-Sink
and Airflow, Vin = Vin(nom)

Characteristic Curves (Continued)

All test conditions are at 25°C. The figures are for PXE30-12S3P3

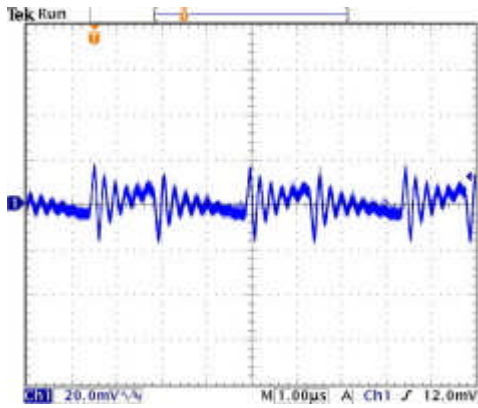

Typical Output Ripple and Noise.
Vin=Vin(nom), Full Load

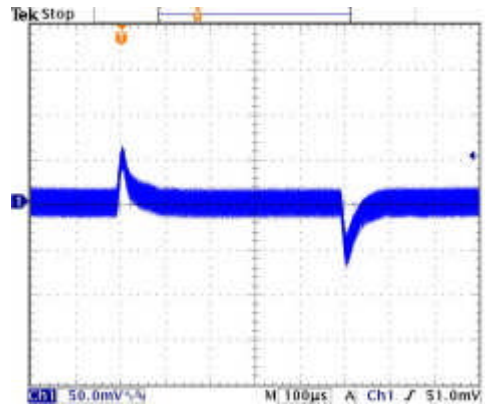

Transient Response to Dynamic Load Change from 100% to 75% to 100% of Full Load ; Vin=Vin(nom)

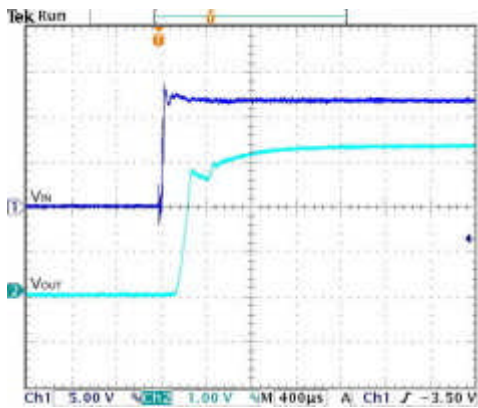

Typical Input Start-Up and Output Rise Characteristic
Vin=Vin(nom), Full Load

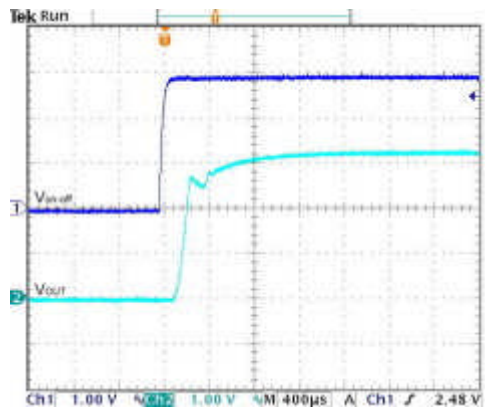

Using ON/OFF Voltage Start-Up and Vo Rise Characteristic
Vin=Vin(nom), Full Load

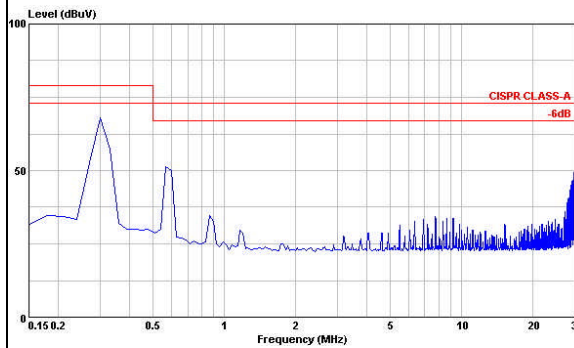

Conduction Emission of EN55022 Class A
Vin=Vin(nom), Full Load

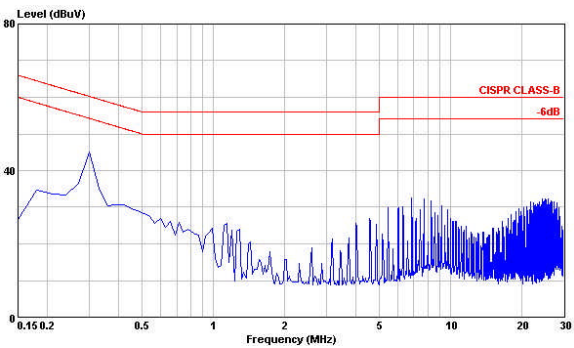

Conduction Emission of EN55022 Class B
Vin=Vin(nom), Full Load

Characteristic Curves (Continued)

All test conditions are at 25°C. The figures are identical for PXE30-12S05

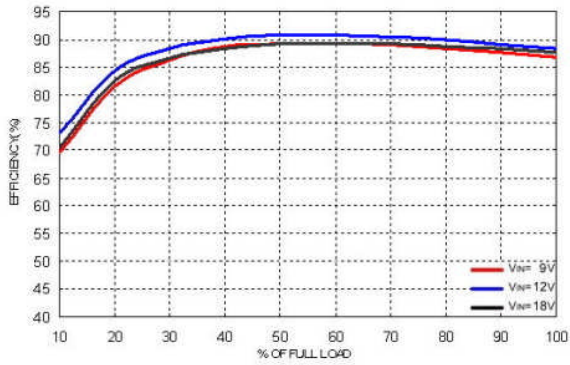

Efficiency Versus Output Current

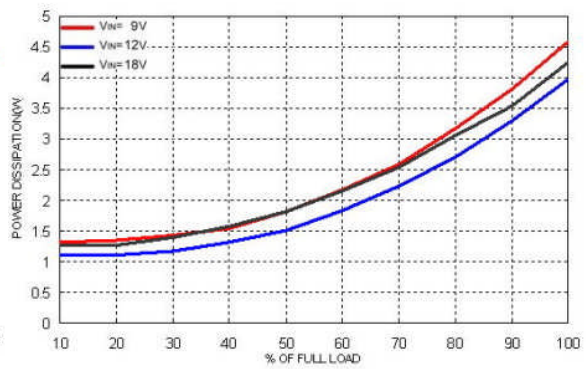

Power Dissipation Versus Output Current

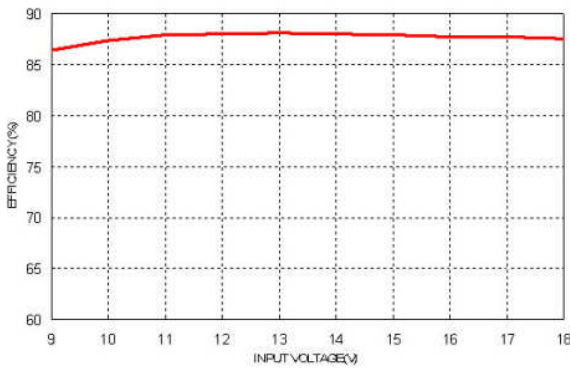

Efficiency Versus Input Voltage. Full Load

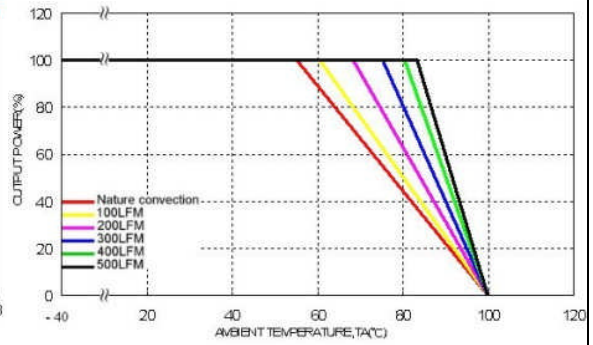

Derating Output Current Versus Ambient Temperature and Airflow
V_{in} = V_{in}(nom)

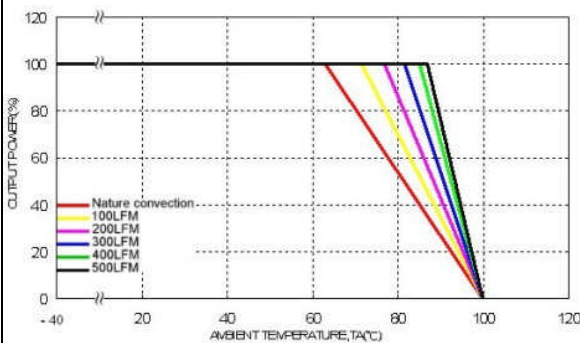

Derating Output Current Versus Ambient Temperature with Heat-Sink
and Airflow, V_{in} = V_{in}(nom)

Characteristic Curves (Continued)

All test conditions are at 25°C. The figures are for PXE30-12S05

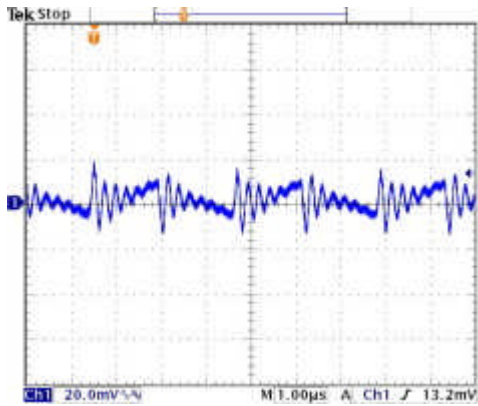

Typical Output Ripple and Noise.
Vin=Vin(nom), Full Load

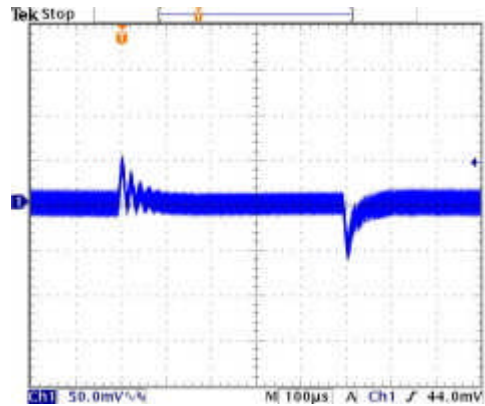

Transient Response to Dynamic Load Change from 100% to 75% to 100% of Full Load ; Vin=Vin(nom)

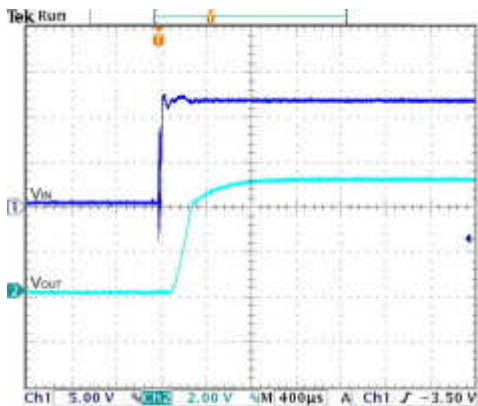

Typical Input Start-Up and Output Rise Characteristic
Vin=Vin(nom), Full Load

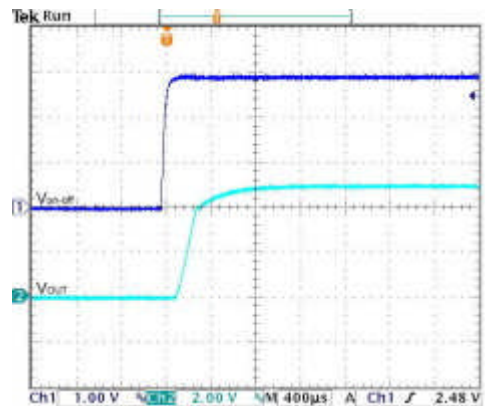

Using ON/OFF Voltage Start-Up and Vo Rise Characteristic
Vin=Vin(nom), Full Load

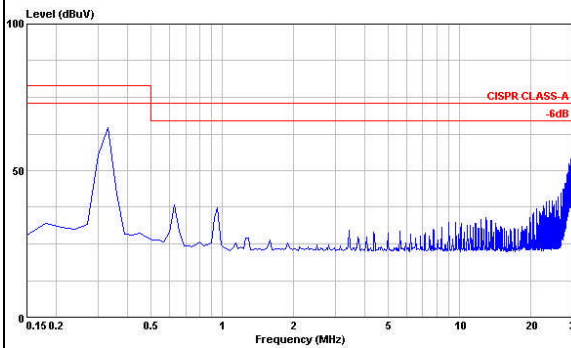

Conduction Emission of EN55022 Class A
Vin=Vin(nom), Full Load

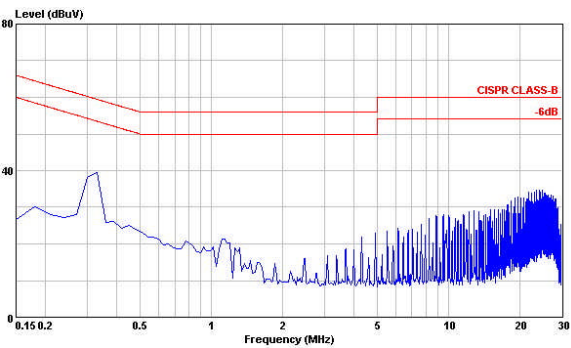

Conduction Emission of EN55022 Class B
Vin=Vin(nom), Full Load

Characteristic Curves (Continued)

All test conditions are at 25°C. The figures are for PXE30-12S12

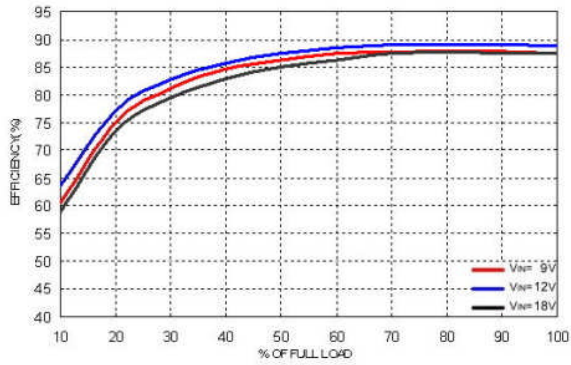

Efficiency Versus Output Current

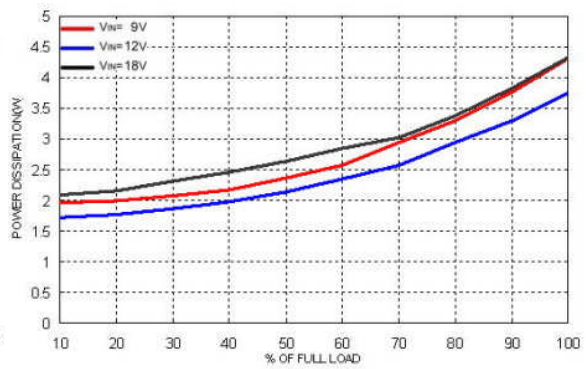

Power Dissipation Versus Output Current

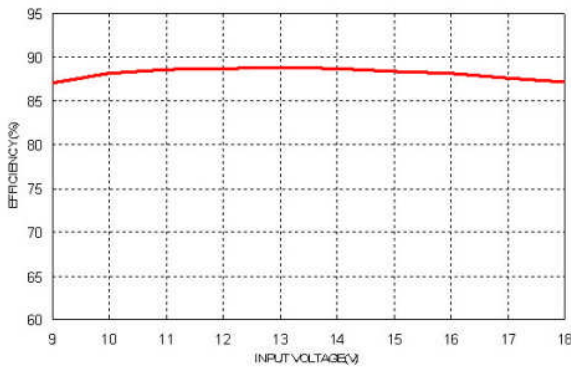

Efficiency Versus Input Voltage. Full Load

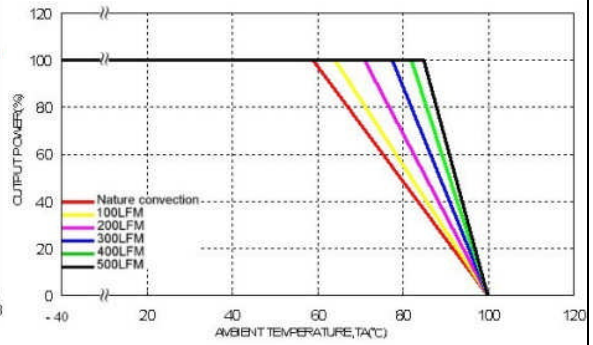

Derating Output Current Versus Ambient Temperature and Airflow
Vin=Vin(nom)

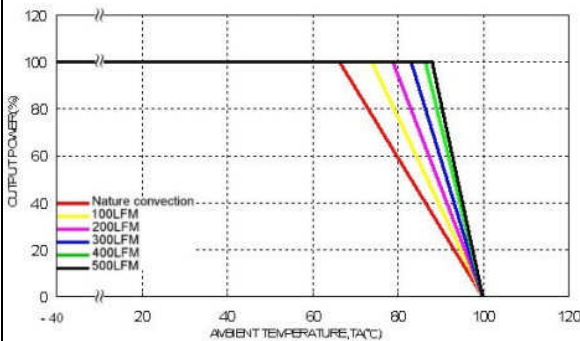

Derating Output Current Versus Ambient Temperature with Heat-Sink
and Airflow, Vin = Vin(nom)

Characteristic Curves (Continued)

All test conditions are at 25°C. The figures are for PXE30-12S12

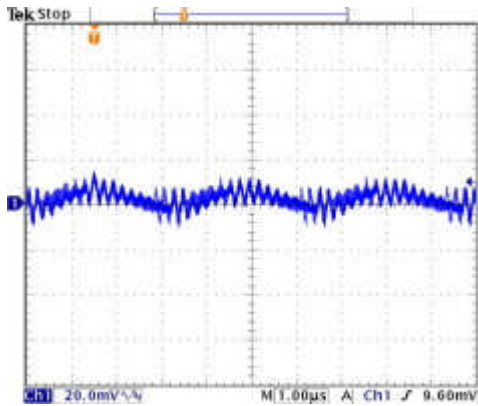

Typical Output Ripple and Noise.
Vin=Vin(nom), Full Load

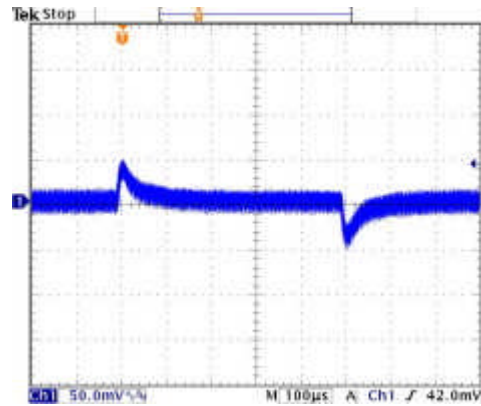

Transient Response to Dynamic Load Change from 100% to 75% to 100% of Full Load ; Vin=Vin(nom)

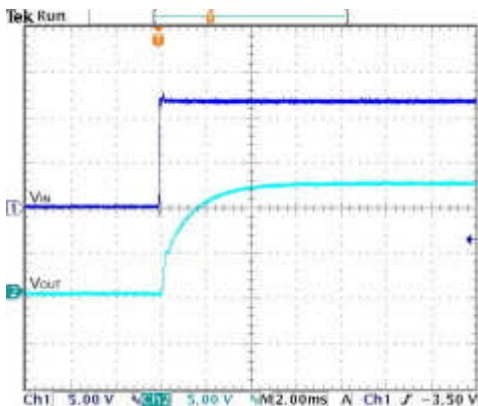

Typical Input Start-Up and Output Rise Characteristic
Vin=Vin(nom), Full Load

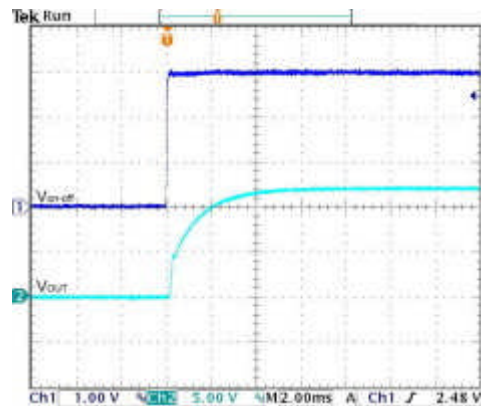

Using ON/OFF Voltage Start-Up and Vo Rise Characteristic
Vin=Vin(nom), Full Load

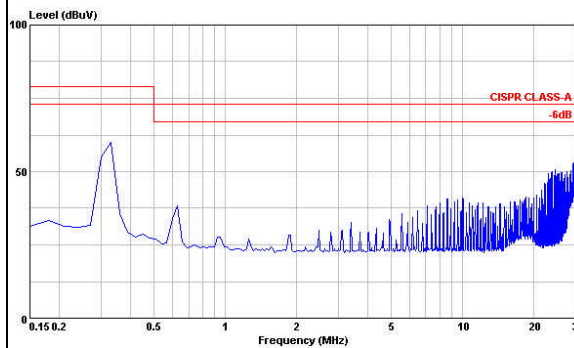

Conduction Emission of EN55022 Class A
Vin=Vin(nom), Full Load

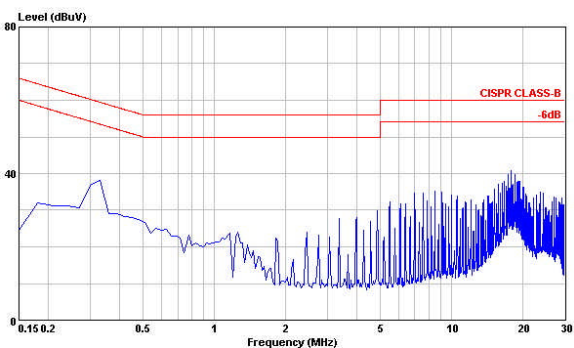

Conduction Emission of EN55022 Class B
Vin=Vin(nom), Full Load

Characteristic Curves (Continued)

All test conditions are at 25°C. The figures are for PXE30-12S15

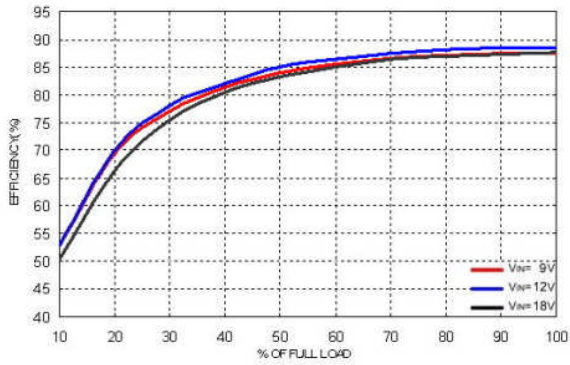

Efficiency Versus Output Current

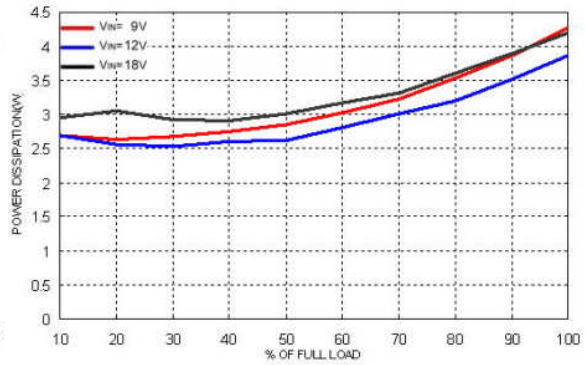

Power Dissipation Versus Output Current

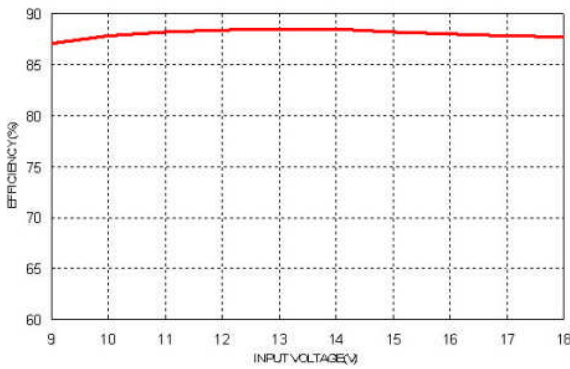

Efficiency Versus Input Voltage. Full Load

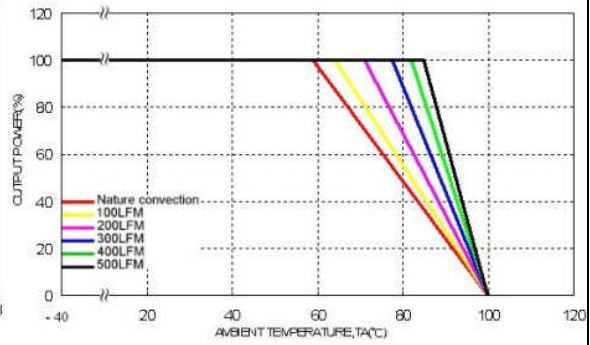

Derating Output Current Versus Ambient Temperature and Airflow
 $V_{in} = V_{in}(\text{nom})$

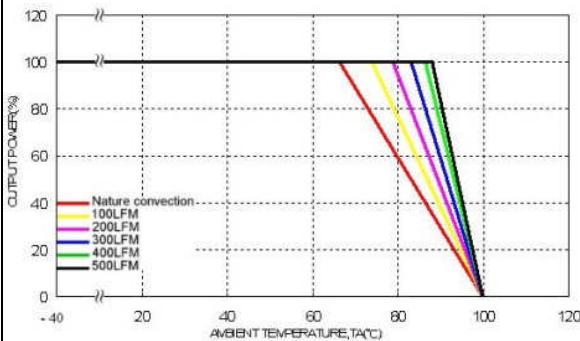

Derating Output Current Versus Ambient Temperature with Heat-Sink
and Airflow, $V_{in} = V_{in}(\text{nom})$

Characteristic Curves (Continued)

All test conditions are at 25°C. The figures are for PXE30-12S15

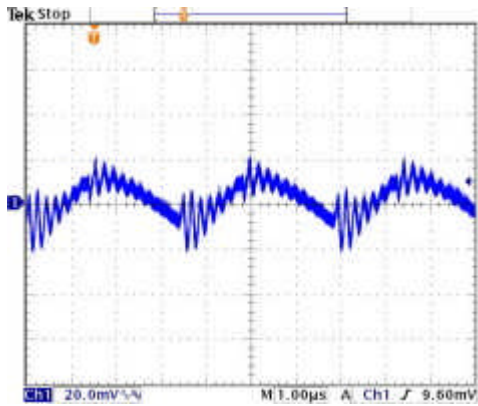

Typical Output Ripple and Noise.
Vin=Vin(nom), Full Load

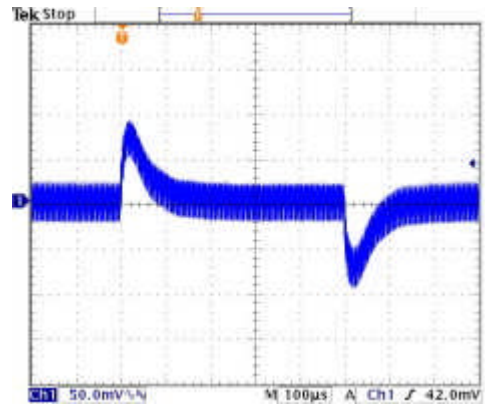

Transient Response to Dynamic Load Change from 100% to 75% to 100% of Full Load ; Vin=Vin(nom)

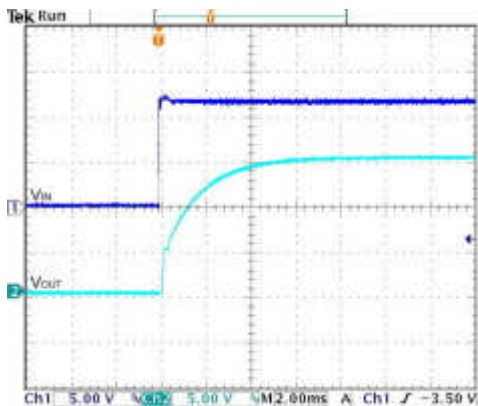

Typical Input Start-Up and Output Rise Characteristic
Vin=Vin(nom), Full Load

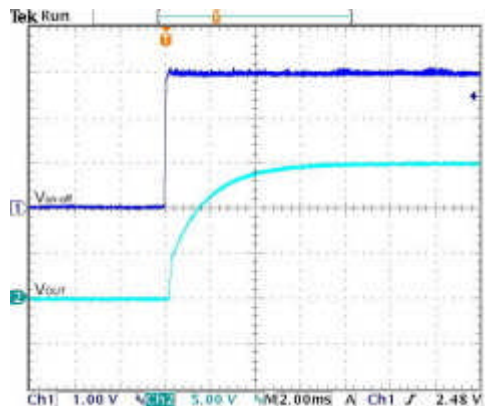

Using ON/OFF Voltage Start-Up and Vo Rise Characteristic
Vin=Vin(nom), Full Load

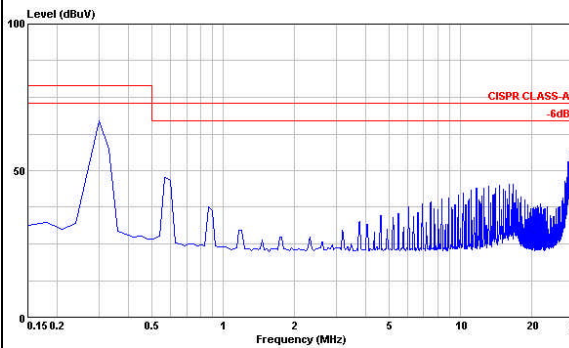

Conduction Emission of EN55022 Class A
Vin=Vin(nom), Full Load

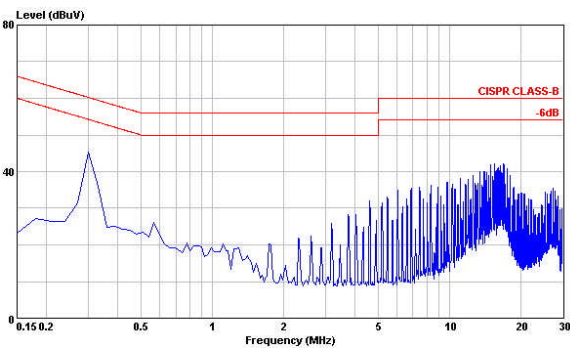

Conduction Emission of EN55022 Class B
Vin=Vin(nom), Full Load

Characteristic Curves (Continued)

All test conditions are at 25°C. The figures are for PXE30-24S1P5

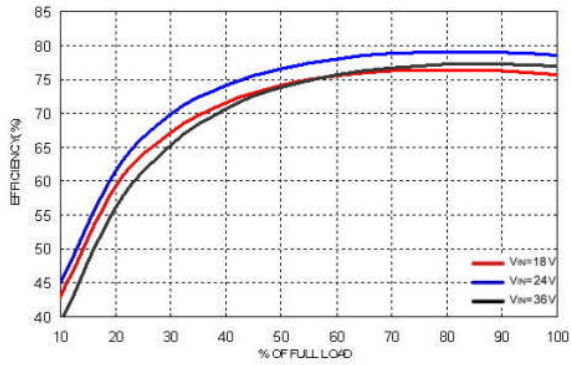

Efficiency Versus Output Current

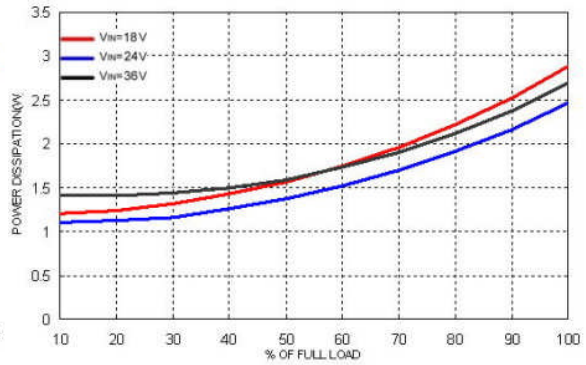

Power Dissipation Versus Output Current

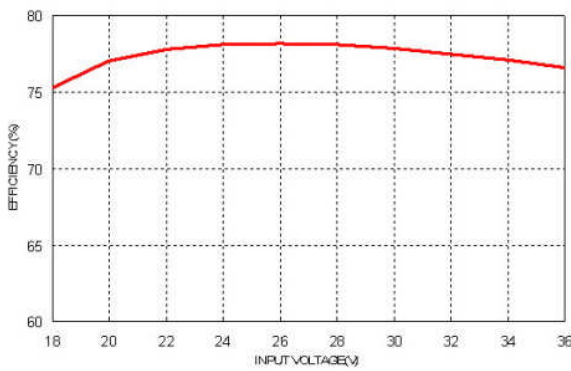

Efficiency Versus Input Voltage. Full Load

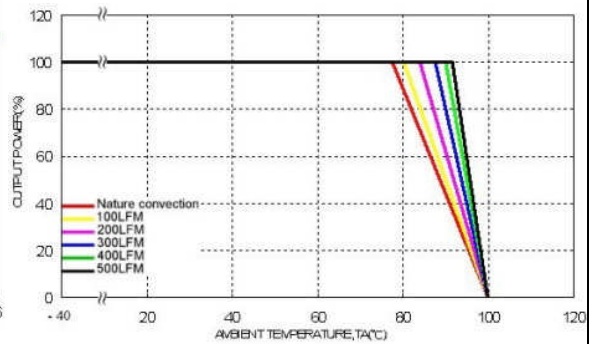

Derating Output Current Versus Ambient Temperature and Airflow
Vin=Vin(nom)

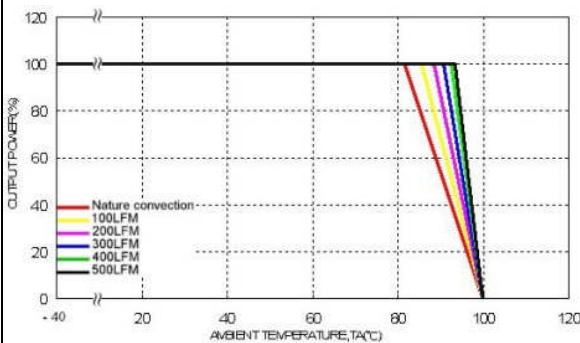

Derating Output Current Versus Ambient Temperature with Heat-Sink
and Airflow, Vin = Vin(nom)

Characteristic Curves (Continued)

All test conditions are at 25°C. The figures are for PXE30-24S1P5

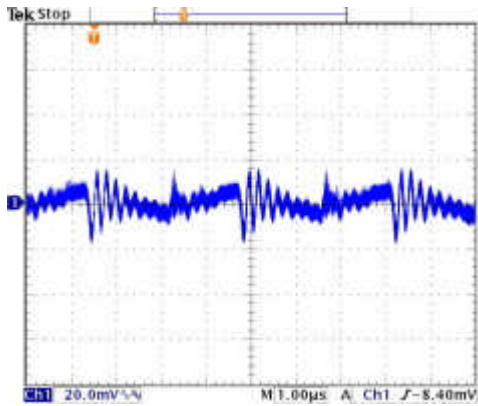

Typical Output Ripple and Noise.
Vin=Vin(nom), Full Load

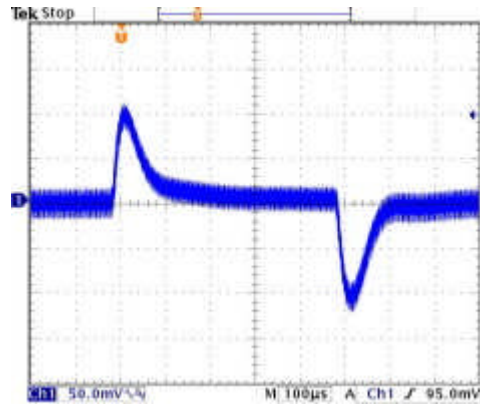

Transient Response to Dynamic Load Change from 100% to 75% to 100% of Full Load ; Vin=Vin(nom)

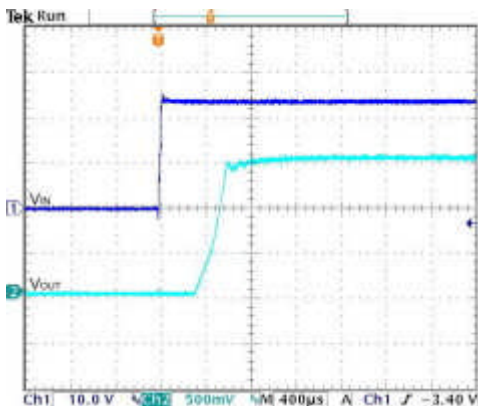

Typical Input Start-Up and Output Rise Characteristic
Vin=Vin(nom), Full Load

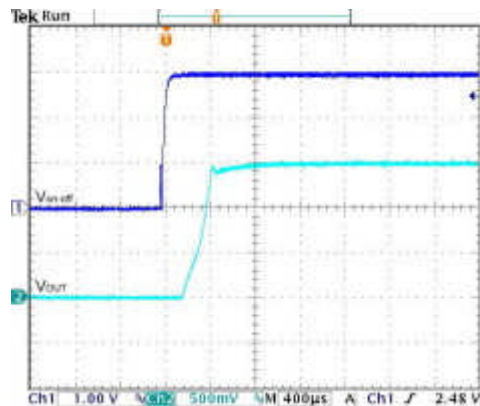

Using ON/OFF Voltage Start-Up and Vo Rise Characteristic
Vin=Vin(nom), Full Load

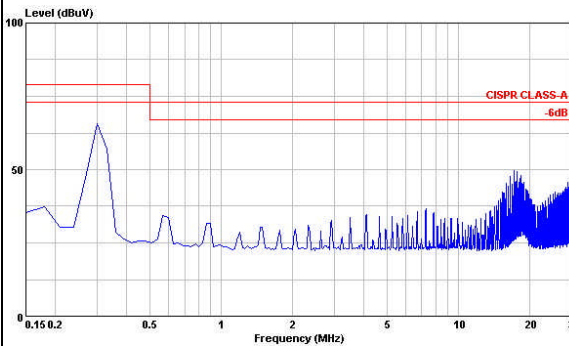

Conduction Emission of EN55022 Class A
Vin=Vin(nom), Full Load

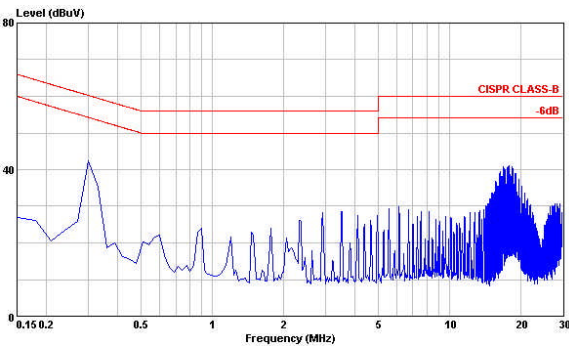

Conduction Emission of EN55022 Class B
Vin=Vin(nom), Full Load

Characteristic Curves (Continued)

All test conditions are at 25°C. The figures are for PXE30-24S1P8

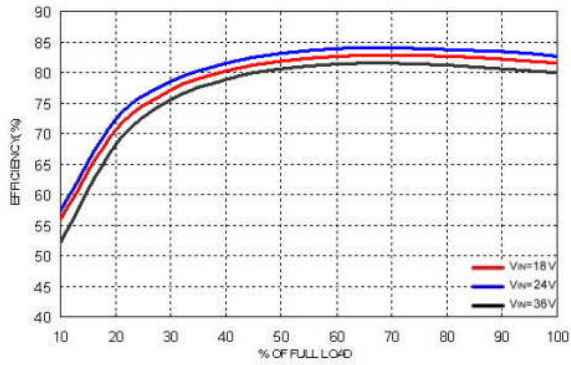

Efficiency Versus Output Current

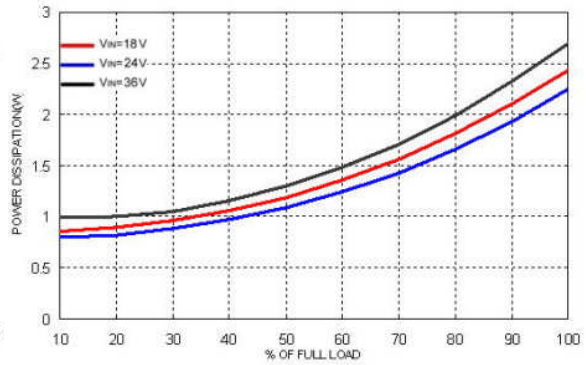

Power Dissipation Versus Output Current

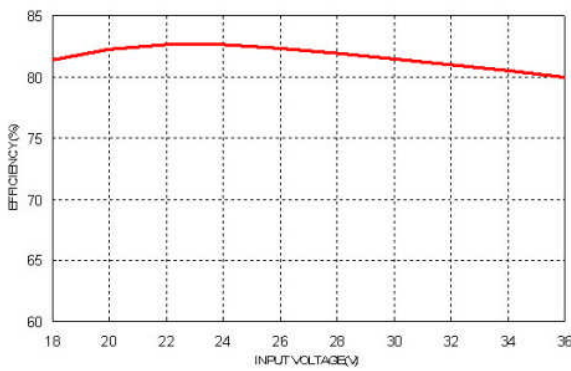

Efficiency Versus Input Voltage. Full Load

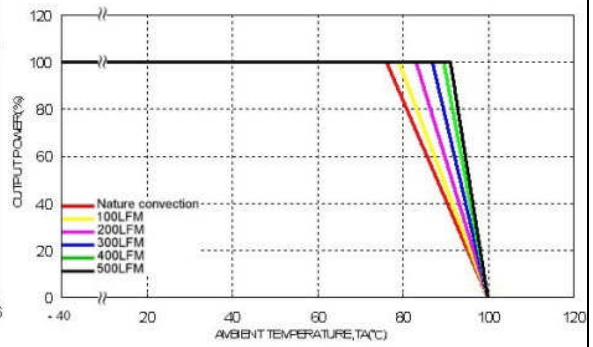

Derating Output Current Versus Ambient Temperature and Airflow
V_{in}=V_{in}(nom)

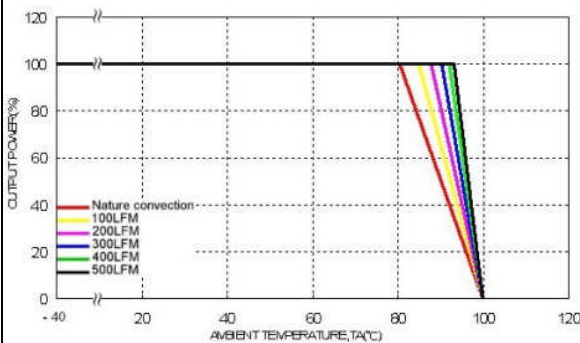

Derating Output Current Versus Ambient Temperature with Heat-Sink
and Airflow, V_{in} = V_{in}(nom)

Characteristic Curves (Continued)

All test conditions are at 25°C. The figures are for PXE30-24S1P8

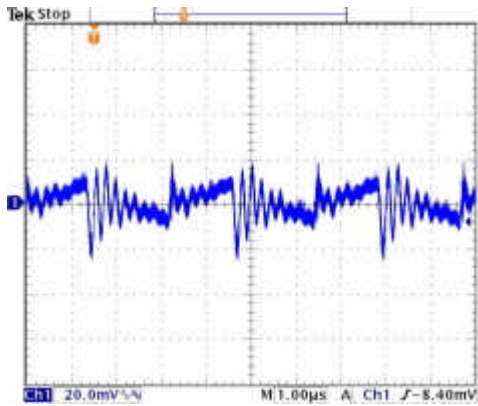

Typical Output Ripple and Noise.
Vin=Vin(nom), Full Load

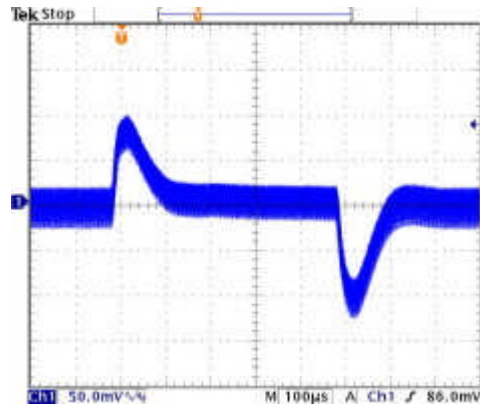

Transient Response to Dynamic Load Change from 100% to 75% to 100% of Full Load ; Vin=Vin(nom)

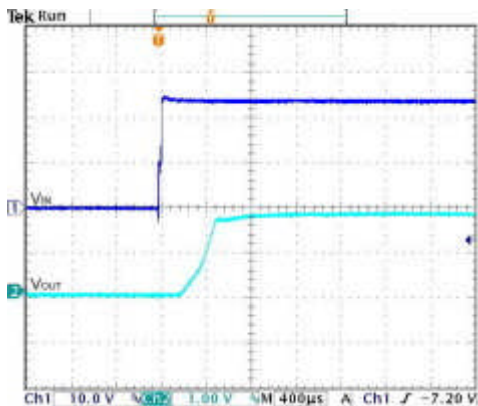

Typical Input Start-Up and Output Rise Characteristic
Vin=Vin(nom), Full Load

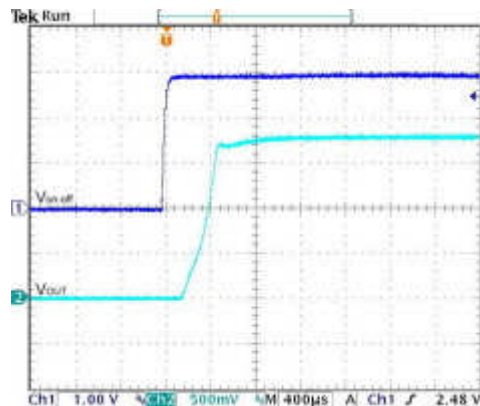

Using ON/OFF Voltage Start-Up and Vo Rise Characteristic
Vin=Vin(nom), Full Load

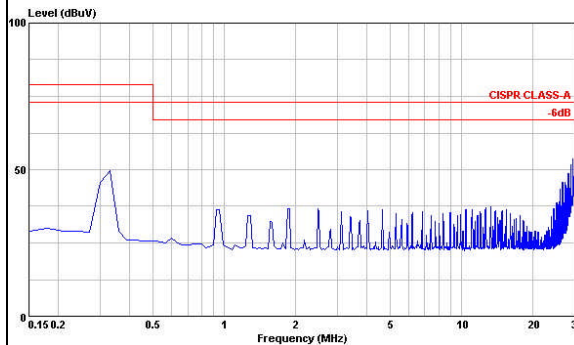

Conduction Emission of EN55022 Class A
Vin=Vin(nom), Full Load

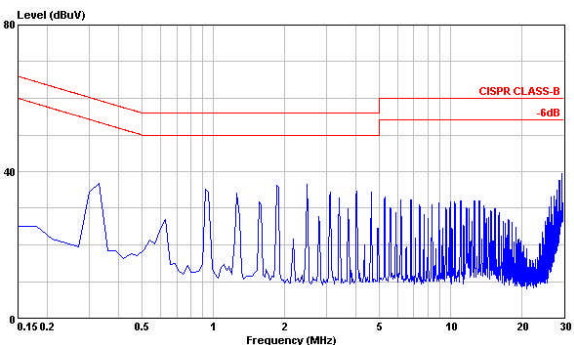

Conduction Emission of EN55022 Class B
Vin=Vin(nom), Full Load

Characteristic Curves (Continued)

All test conditions are at 25°C. The figures are for PXE30-24S2P5

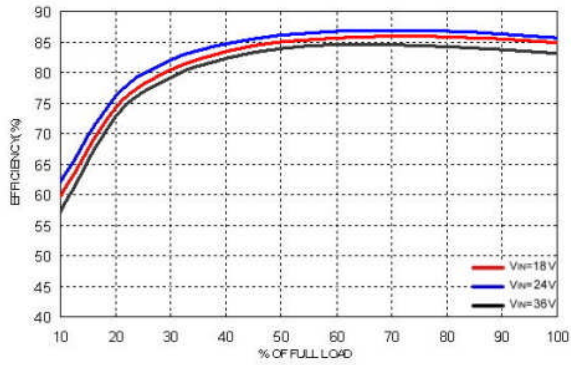

Efficiency Versus Output Current

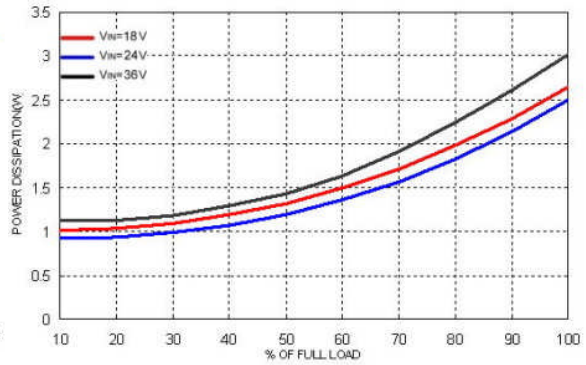

Power Dissipation Versus Output Current

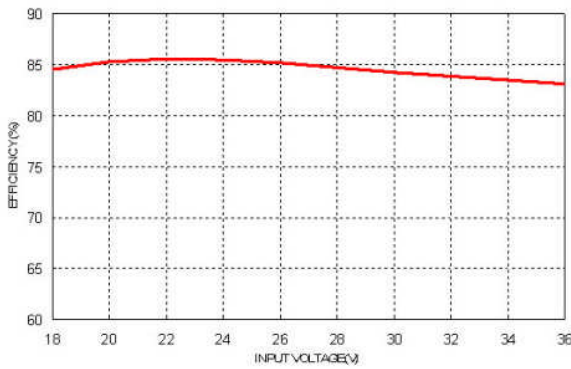

Efficiency Versus Input Voltage. Full Load

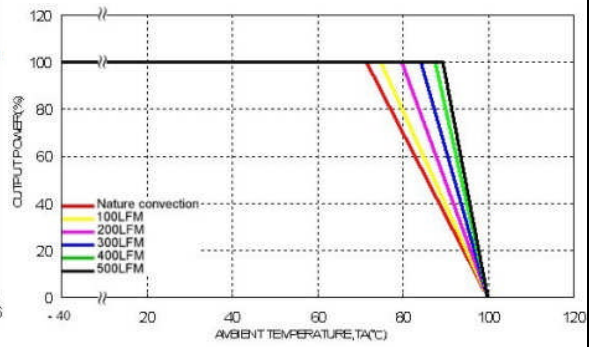

Derating Output Current Versus Ambient Temperature and Airflow
Vin=Vin(nom)

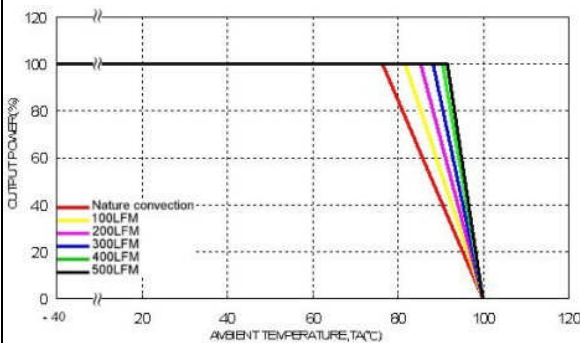

Derating Output Current Versus Ambient Temperature with Heat-Sink
and Airflow, Vin = Vin(nom)

Characteristic Curves (Continued)

All test conditions are at 25°C. The figures are for PXE30-24S2P5

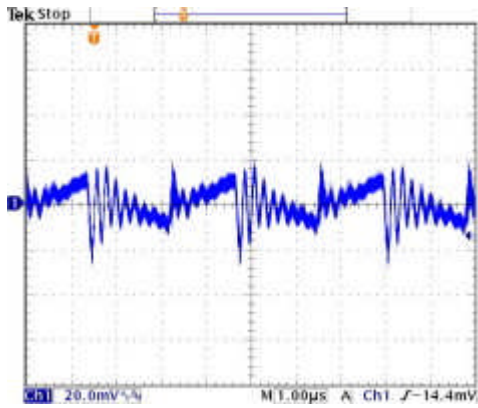

Typical Output Ripple and Noise.
Vin=Vin(nom), Full Load

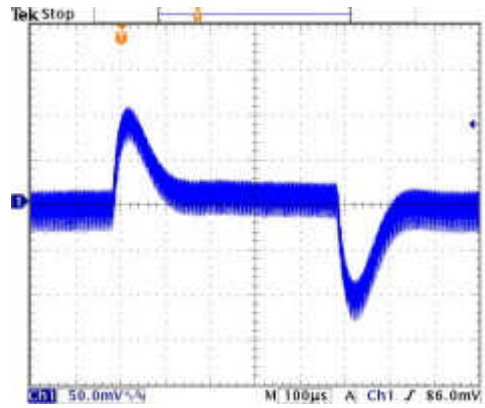

Transient Response to Dynamic Load Change from 100% to 75% to 100% of Full Load ; Vin=Vin(nom)

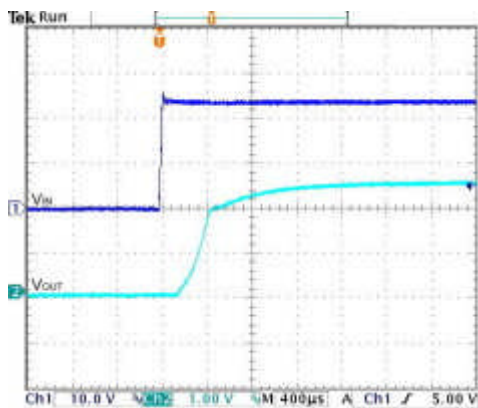

Typical Input Start-Up and Output Rise Characteristic
Vin=Vin(nom), Full Load

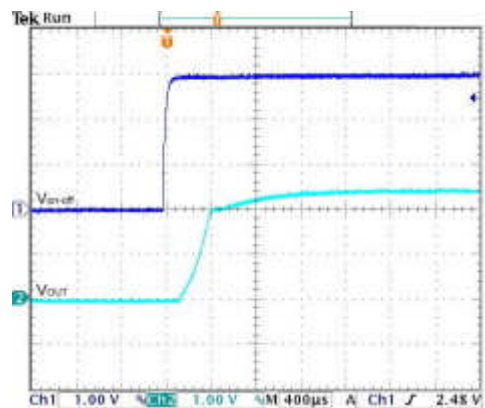

Using ON/OFF Voltage Start-Up and Vo Rise Characteristic
Vin=Vin(nom), Full Load

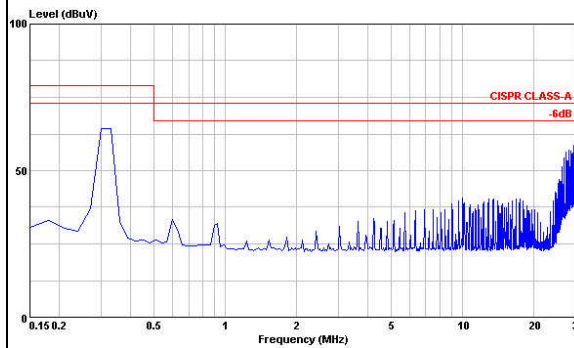

Conduction Emission of EN55022 Class A
Vin=Vin(nom), Full Load

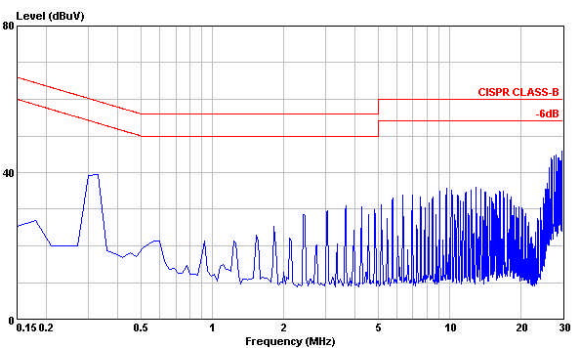

Conduction Emission of EN55022 Class B
Vin=Vin(nom), Full Load

Characteristic Curves (Continued)

All test conditions are at 25°C. The figures are for PXE30-24S3P3

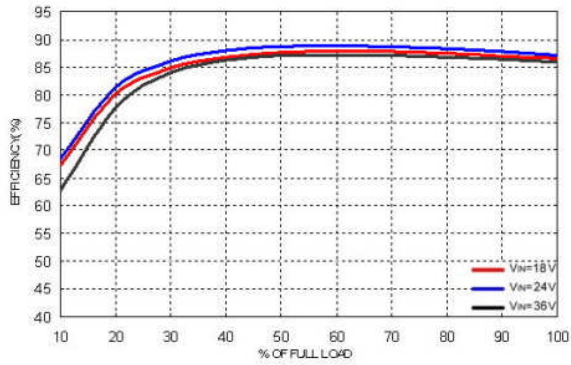

Efficiency Versus Output Current

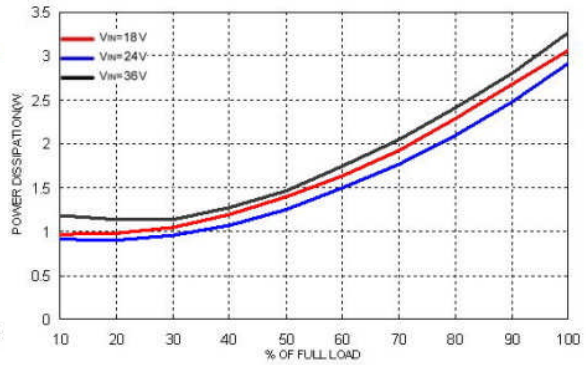

Power Dissipation Versus Output Current

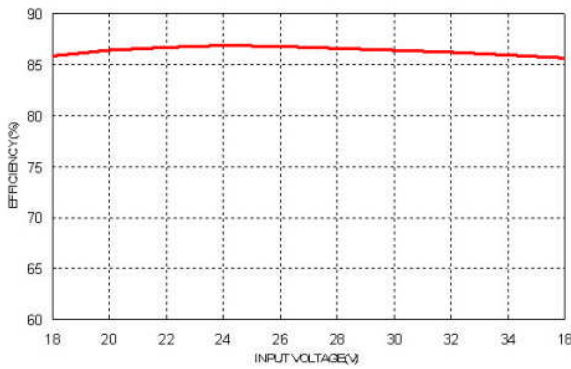

Efficiency Versus Input Voltage. Full Load

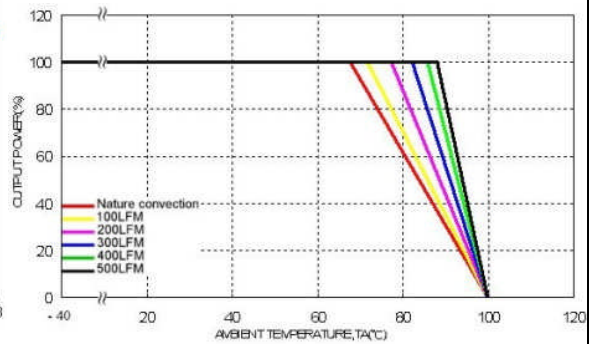

Derating Output Current Versus Ambient Temperature and Airflow
Vin=Vin(nom)

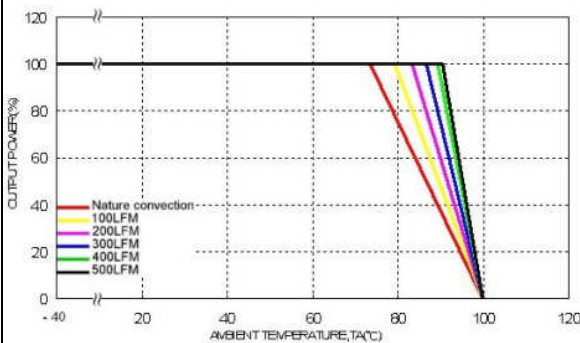

Derating Output Current Versus Ambient Temperature with Heat-Sink
and Airflow, Vin = Vin(nom)

Characteristic Curves (Continued)

All test conditions are at 25°C. The figures are for PXE30-24S3P3

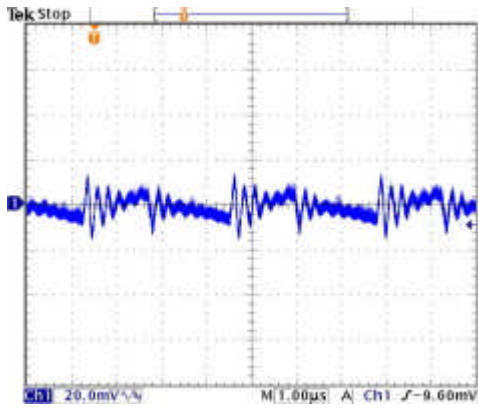

Typical Output Ripple and Noise.
Vin=Vin(nom), Full Load

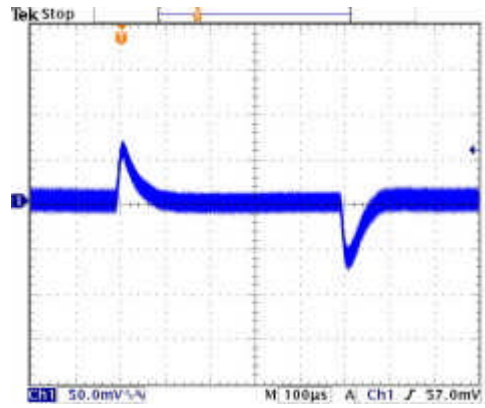

Transient Response to Dynamic Load Change from 100% to 75% to 100% of Full Load ; Vin=Vin(nom)

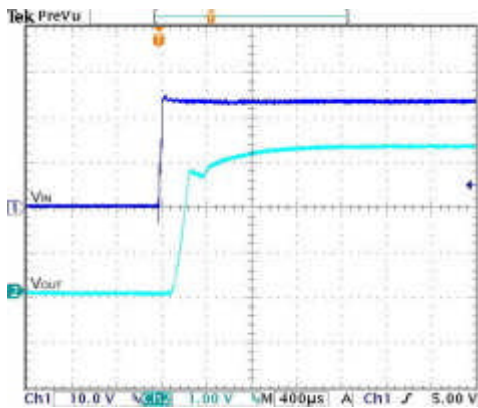

Typical Input Start-Up and Output Rise Characteristic
Vin=Vin(nom), Full Load

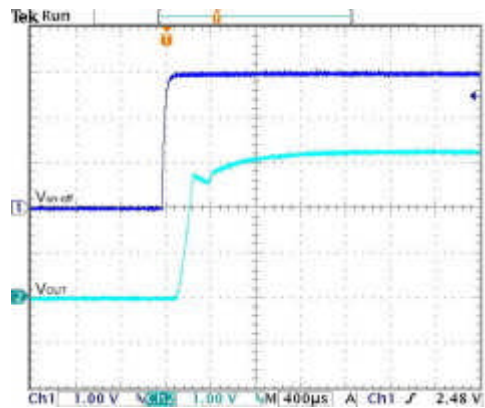

Using ON/OFF Voltage Start-Up and Vo Rise Characteristic
Vin=Vin(nom), Full Load

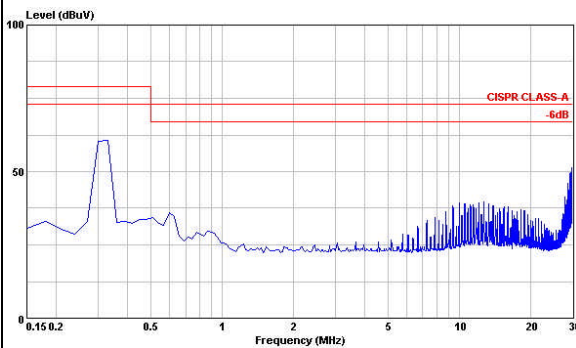

Conduction Emission of EN55022 Class A
Vin=Vin(nom), Full Load

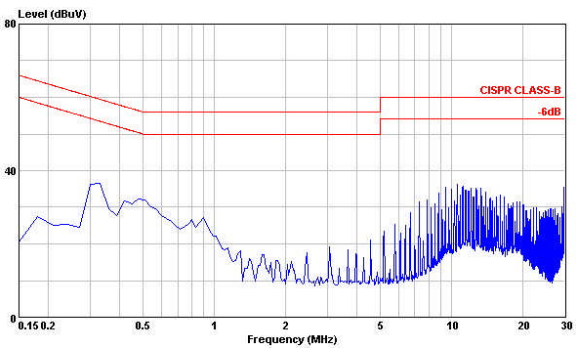

Conduction Emission of EN55022 Class B
Vin=Vin(nom), Full Load

Characteristic Curves (Continued)

All test conditions are at 25°C. The figures are for PXE30-24S05

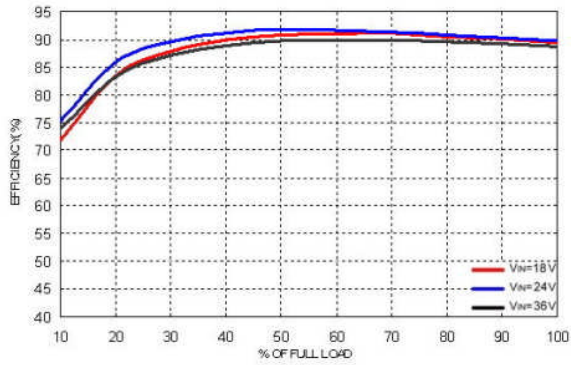

Efficiency Versus Output Current

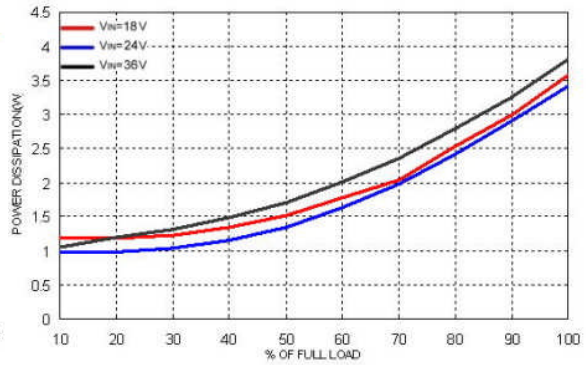

Power Dissipation Versus Output Current

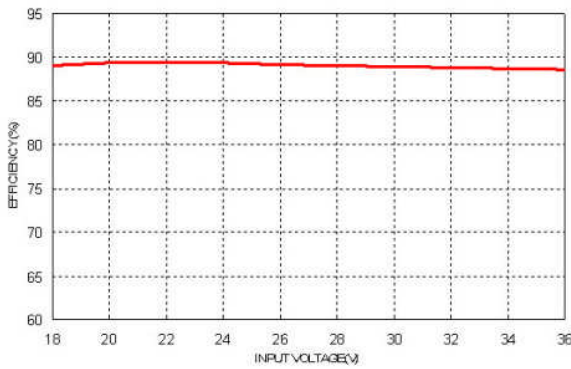

Efficiency Versus Input Voltage. Full Load

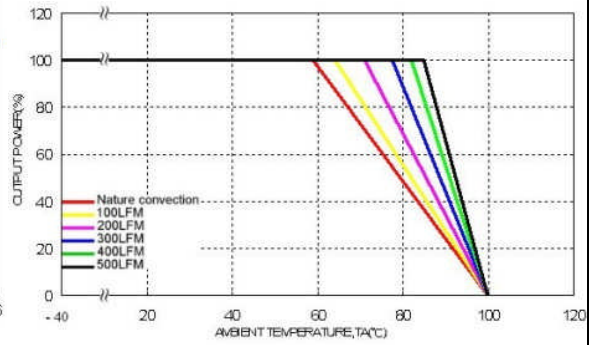

Derating Output Current Versus Ambient Temperature and Airflow
V_{in}=V_{in}(nom)

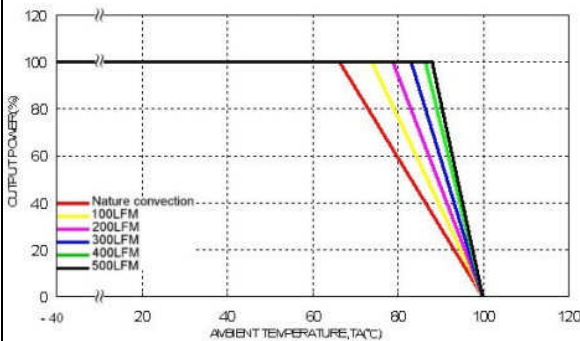

Derating Output Current Versus Ambient Temperature with Heat-Sink
and Airflow, V_{in} = V_{in}(nom)

Characteristic Curves (Continued)

All test conditions are at 25°C. The figures are for PXE30-24S05

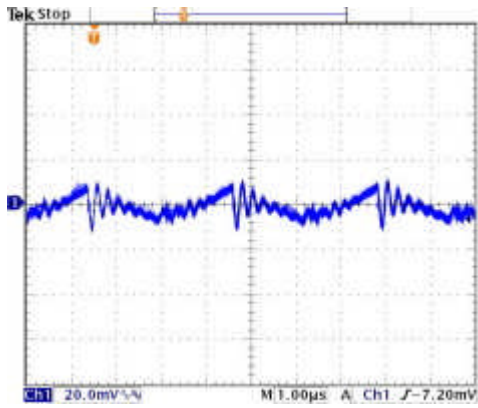

Typical Output Ripple and Noise.
Vin=Vin(nom), Full Load

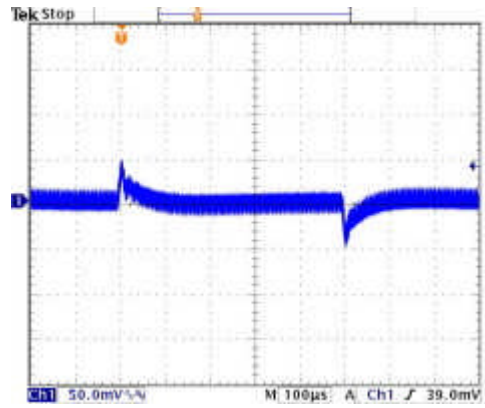

Transient Response to Dynamic Load Change from 100% to 75% to 100% of Full Load ; Vin=Vin(nom)

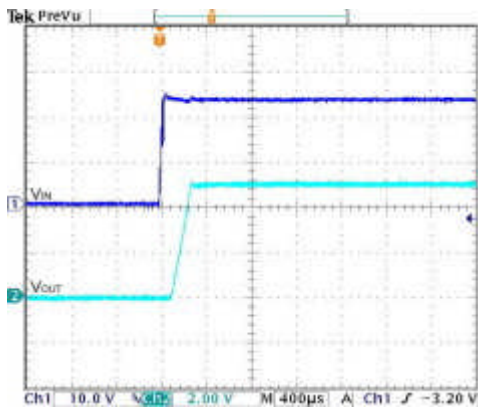

Typical Input Start-Up and Output Rise Characteristic
Vin=Vin(nom), Full Load

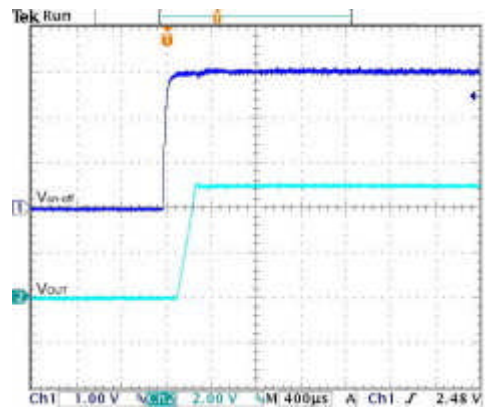

Using ON/OFF Voltage Start-Up and Vo Rise Characteristic
Vin=Vin(nom), Full Load

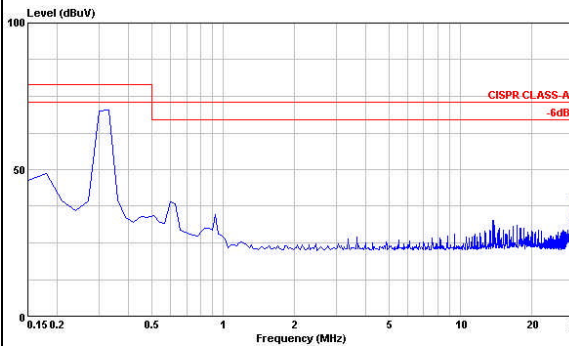

Conduction Emission of EN55022 Class A
Vin=Vin(nom), Full Load

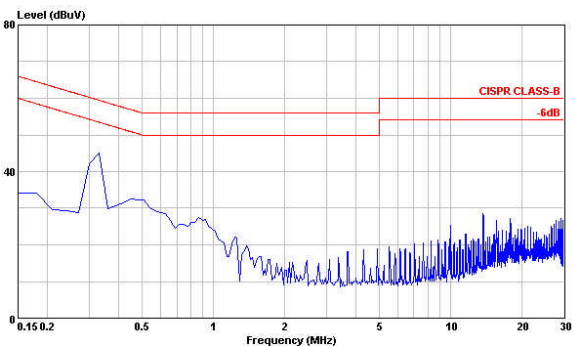

Conduction Emission of EN55022 Class B
Vin=Vin(nom), Full Load

Characteristic Curves (Continued)

All test conditions are at 25°C. The figures are for PXE30-24S12

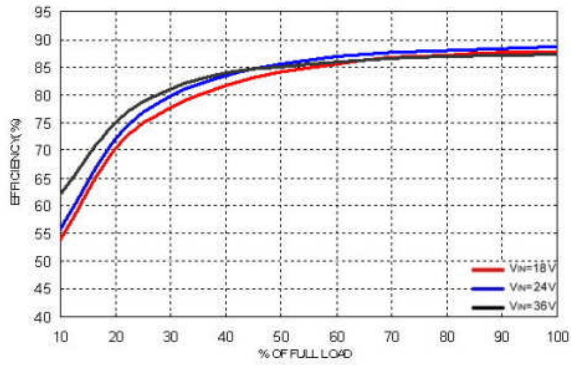

Efficiency Versus Output Current

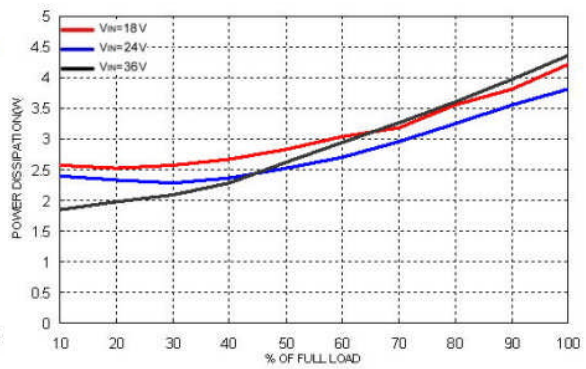

Power Dissipation Versus Output Current

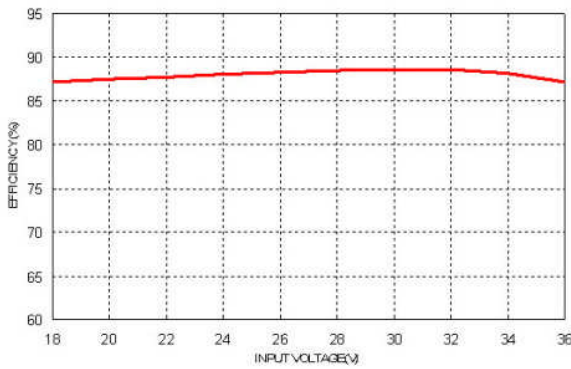

Efficiency Versus Input Voltage. Full Load

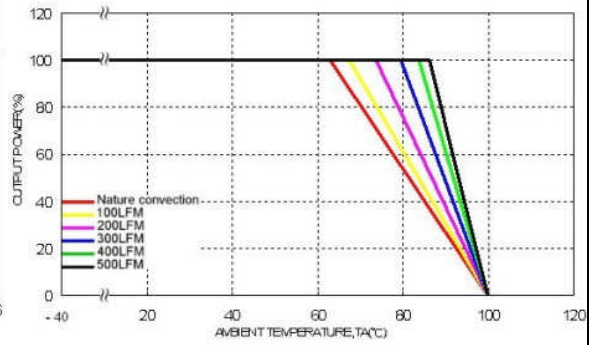

Derating Output Current Versus Ambient Temperature and Airflow
Vin=Vin(nom)

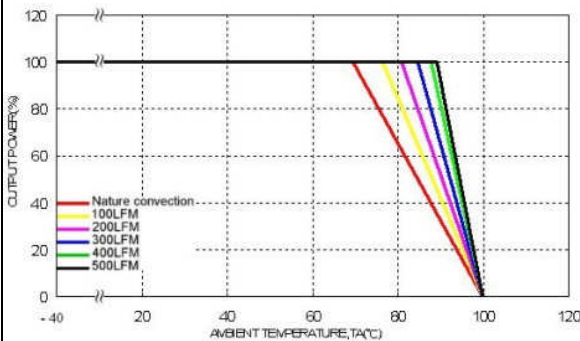

Derating Output Current Versus Ambient Temperature with Heat-Sink
and Airflow, Vin = Vin(nom)

Characteristic Curves (Continued)

All test conditions are at 25°C. The figures are for PXE30-24S12

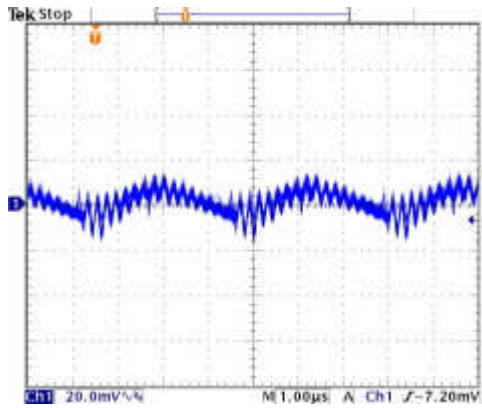

Typical Output Ripple and Noise.
Vin=Vin(nom), Full Load

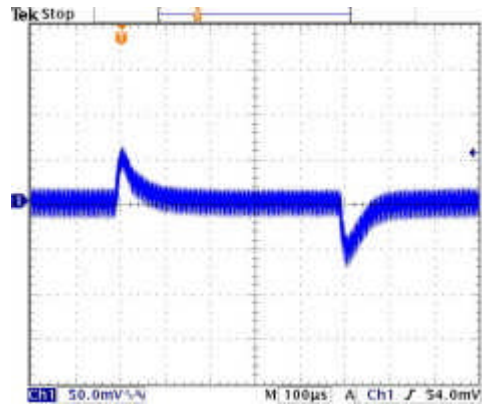

Transient Response to Dynamic Load Change from 100% to 75% to 100% of Full Load ; Vin=Vin(nom)

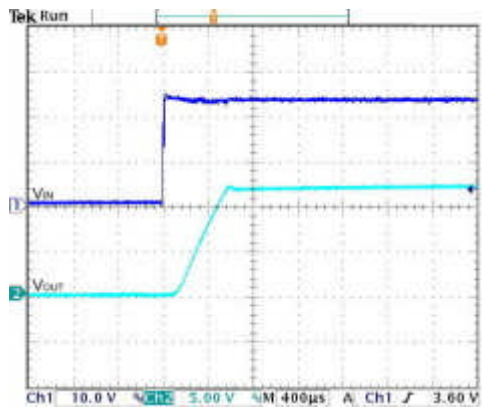

Typical Input Start-Up and Output Rise Characteristic
Vin=Vin(nom), Full Load

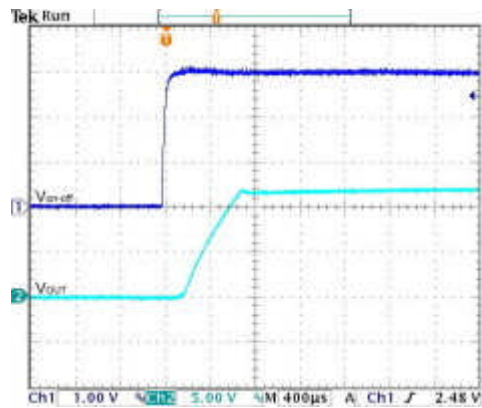

Using ON/OFF Voltage Start-Up and Vo Rise Characteristic
Vin=Vin(nom), Full Load

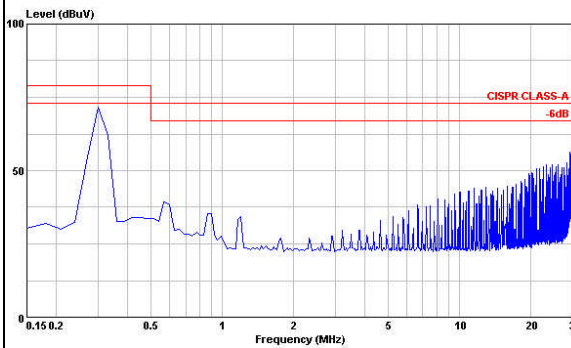

Conduction Emission of EN55022 Class A
Vin=Vin(nom), Full Load

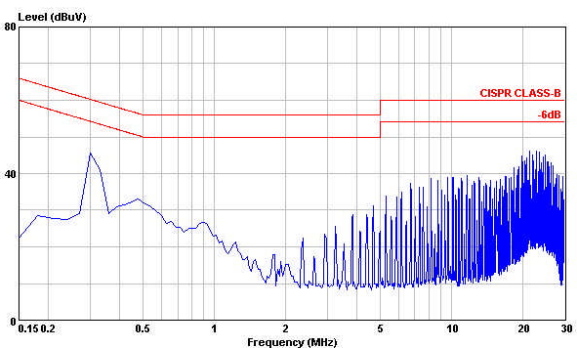

Conduction Emission of EN55022 Class B
Vin=Vin(nom), Full Load

Characteristic Curves (Continued)

All test conditions are at 25°C. The figures are for PXE30-24S15

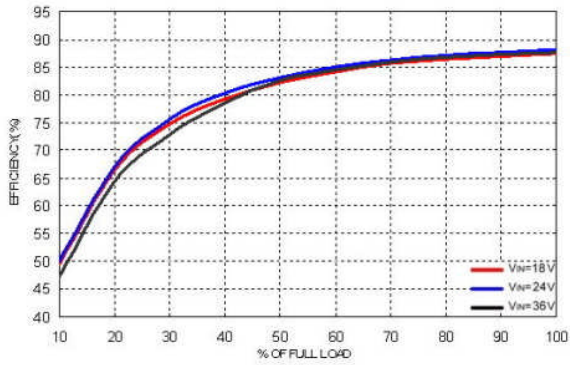

Efficiency Versus Output Current

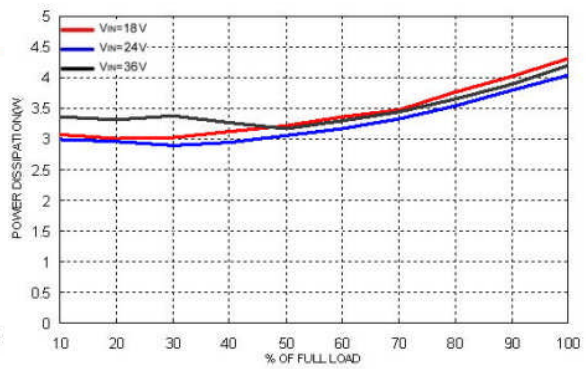

Power Dissipation Versus Output Current

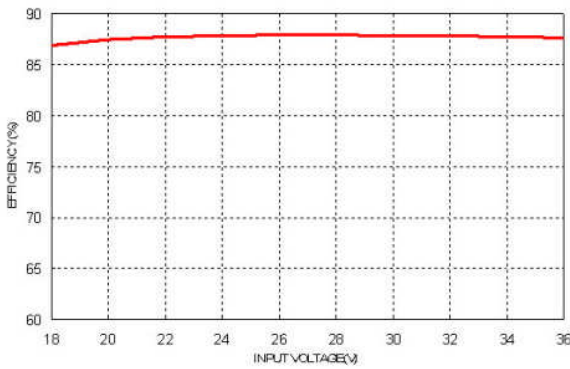

Efficiency Versus Input Voltage. Full Load

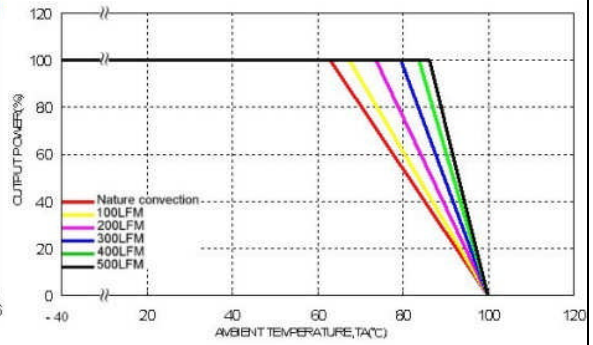

Derating Output Current Versus Ambient Temperature and Airflow
Vin=Vin(nom)

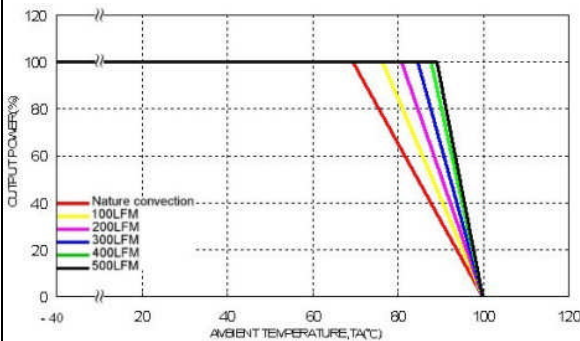

Derating Output Current Versus Ambient Temperature with Heat-Sink
and Airflow, Vin = Vin(nom)

Characteristic Curves (Continued)

All test conditions are at 25°C. The figures are for PXE30-24S15

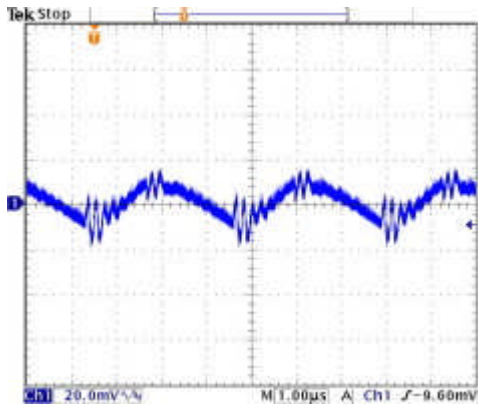

Typical Output Ripple and Noise.
Vin=Vin(nom), Full Load

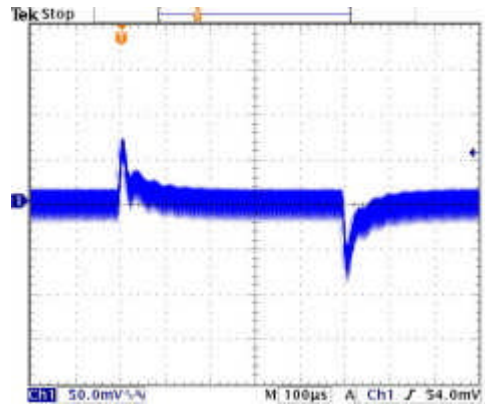

Transient Response to Dynamic Load Change from 100% to 75% to 100% of Full Load ; Vin=Vin(nom)

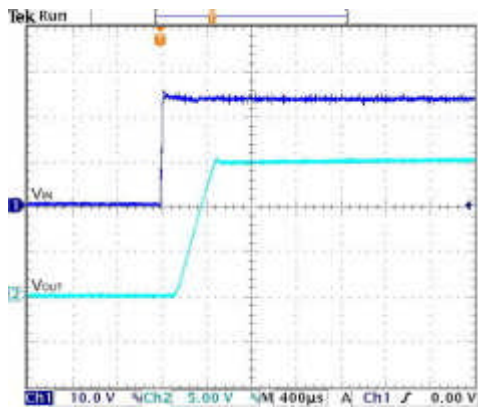

Typical Input Start-Up and Output Rise Characteristic
Vin=Vin(nom), Full Load

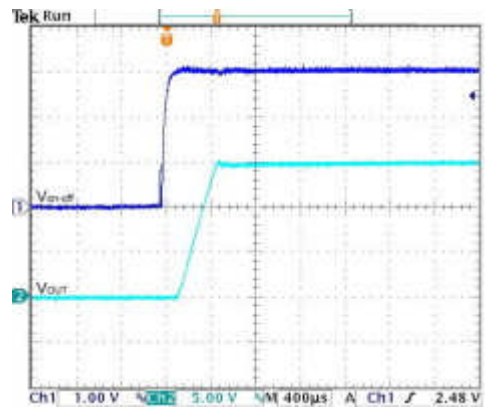

Using ON/OFF Voltage Start-Up and Vo Rise Characteristic
Vin=Vin(nom), Full Load

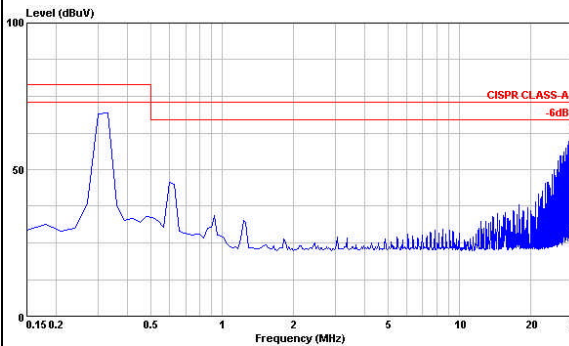

Conduction Emission of EN55022 Class A
Vin=Vin(nom), Full Load

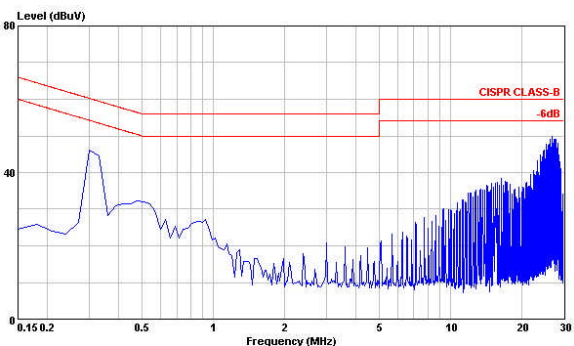

Conduction Emission of EN55022 Class B
Vin=Vin(nom), Full Load

Characteristic Curves (Continued)

All test conditions are at 25°C. The figures are for PXE30-48S1P5

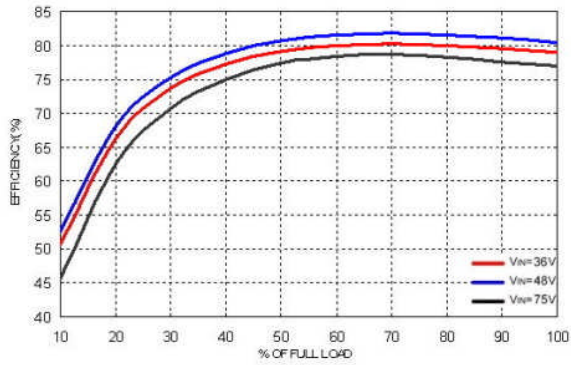

Efficiency Versus Output Current

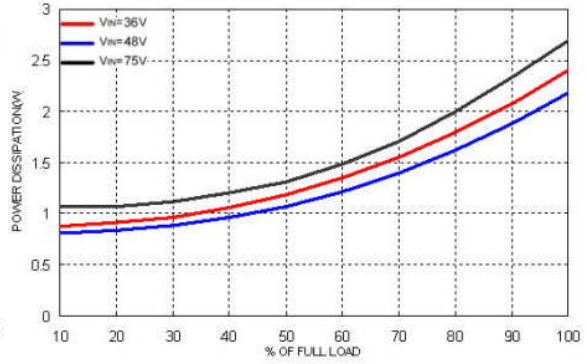

Power Dissipation Versus Output Current

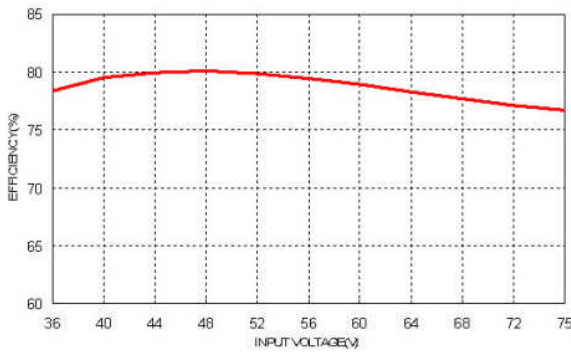

Efficiency Versus Input Voltage. Full Load

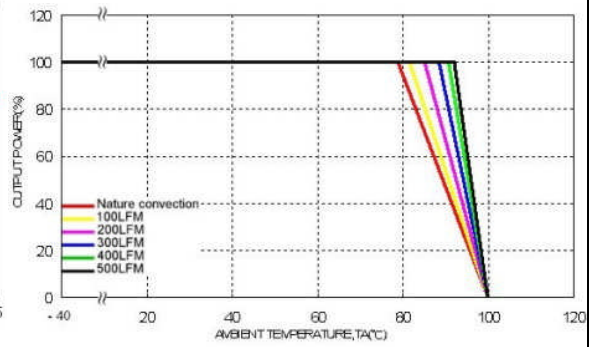

Derating Output Current Versus Ambient Temperature and Airflow
Vin=Vin(nom)

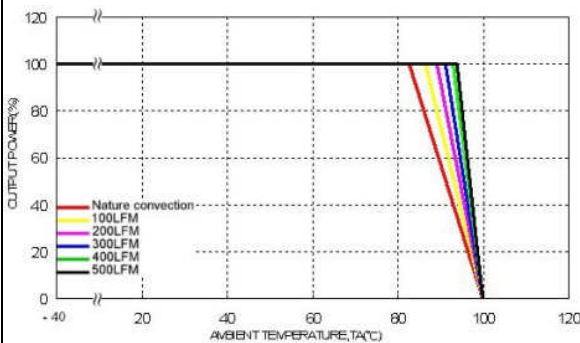

Derating Output Current Versus Ambient Temperature with Heat-Sink
and Airflow, Vin = Vin(nom)

Characteristic Curves (Continued)

All test conditions are at 25°C. The figures are for PXE30-48S1P5

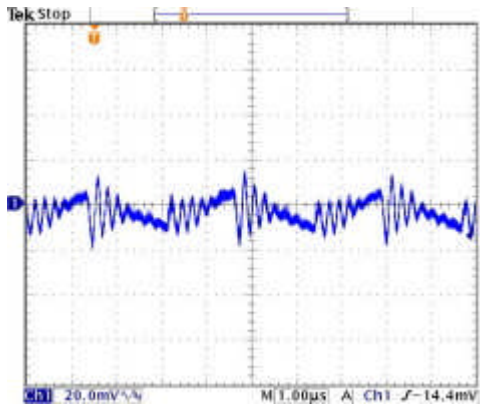

Typical Output Ripple and Noise.
Vin=Vin(nom), Full Load

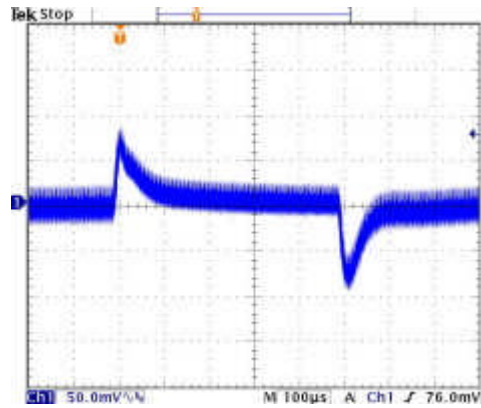

Transient Response to Dynamic Load Change from 100% to 75% to 100% of Full Load ; Vin=Vin(nom)

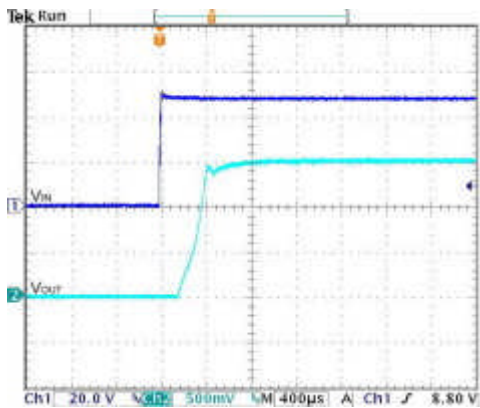

Typical Input Start-Up and Output Rise Characteristic
Vin=Vin(nom), Full Load

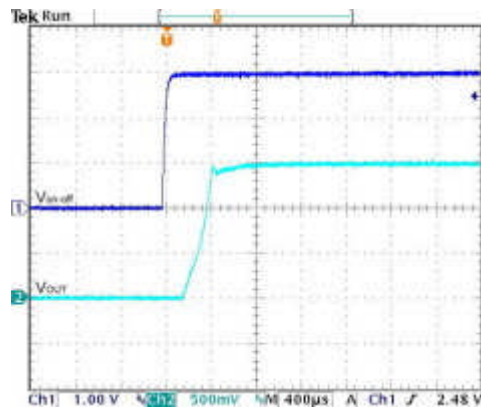

Using ON/OFF Voltage Start-Up and V_o Rise Characteristic
Vin=Vin(nom), Full Load

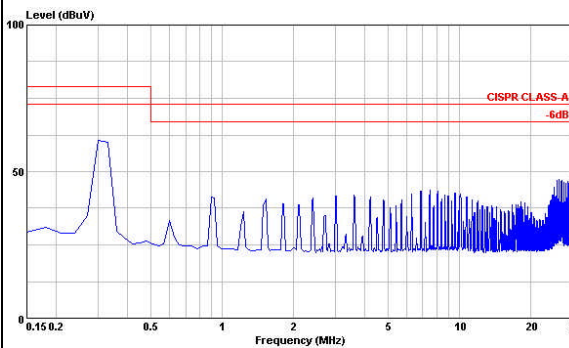

Conduction Emission of EN55022 Class A
Vin=Vin(nom), Full Load

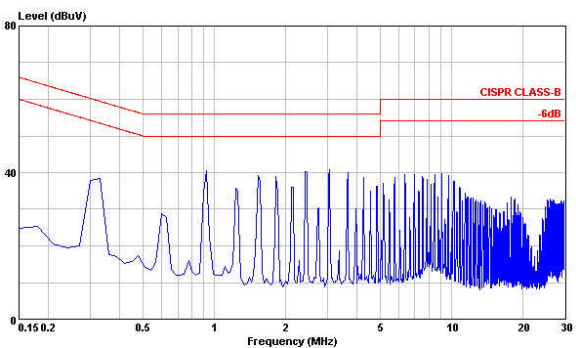

Conduction Emission of EN55022 Class B
Vin=Vin(nom), Full Load

Characteristic Curves (Continued)

All test conditions are at 25°C. The figures are for PXE30-48S1P8

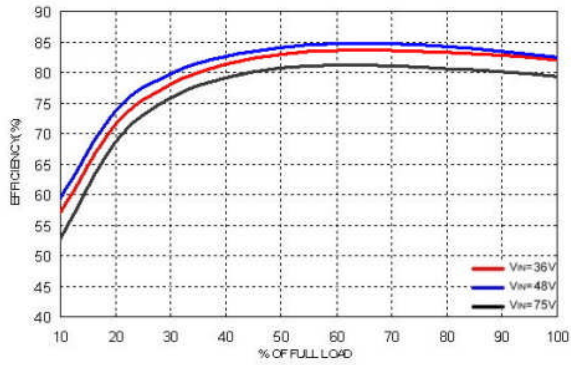

Efficiency Versus Output Current

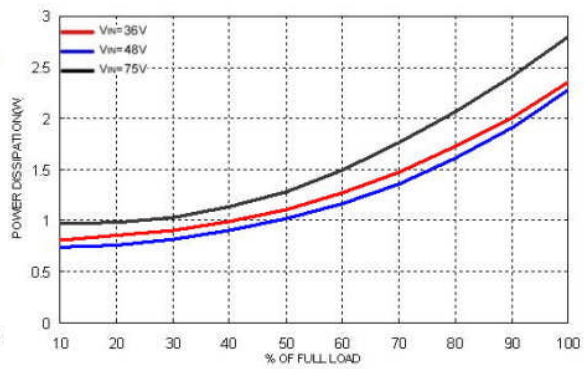

Power Dissipation Versus Output Current

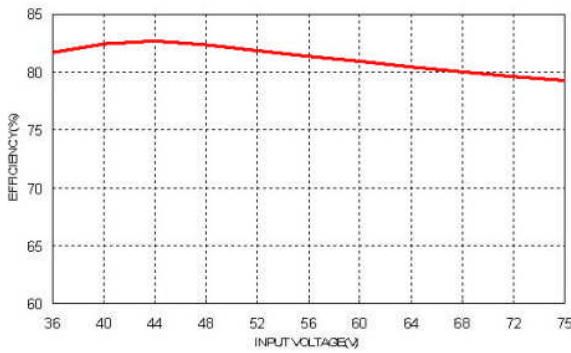

Efficiency Versus Input Voltage. Full Load

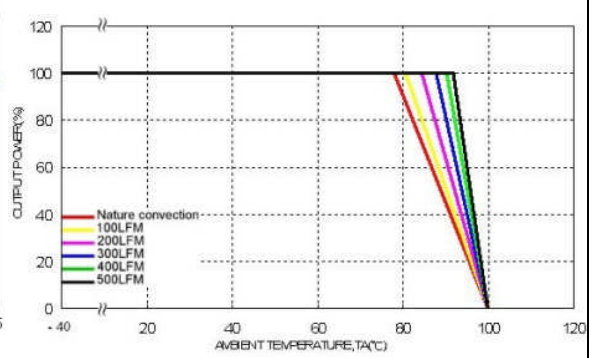

Derating Output Current Versus Ambient Temperature and Airflow
Vin=Vin(nom)

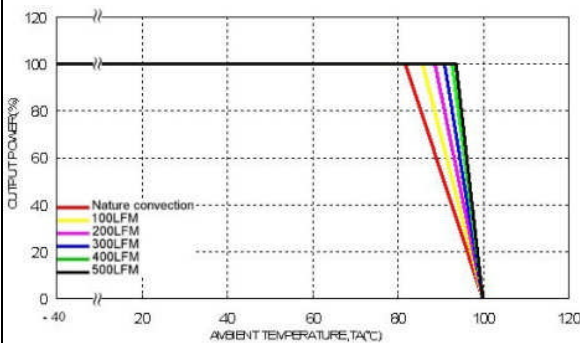

Derating Output Current Versus Ambient Temperature with Heat-Sink
and Airflow, Vin = Vin(nom)

Characteristic Curves (Continued)

All test conditions are at 25°C. The figures are for PXE30-48S1P8

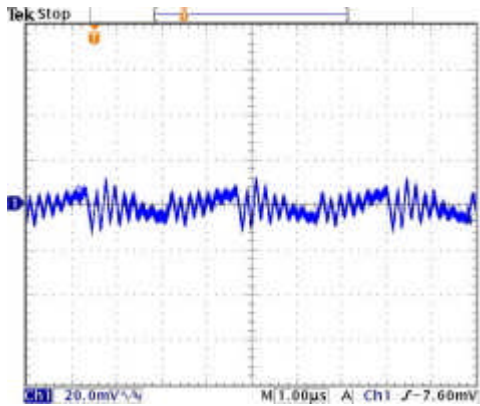

Typical Output Ripple and Noise.
Vin=Vin(nom), Full Load

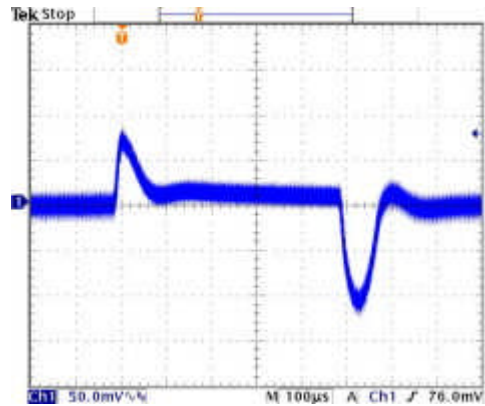

Transient Response to Dynamic Load Change from 100% to 75% to 100% of Full Load ; Vin=Vin(nom)

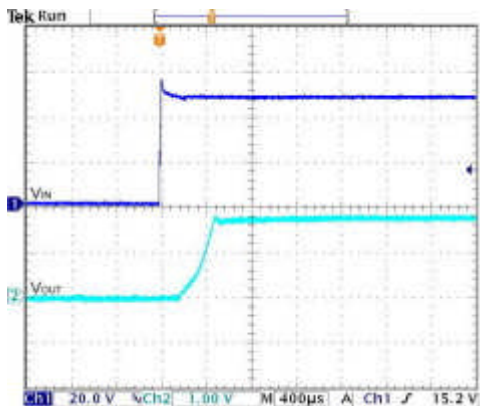

Typical Input Start-Up and Output Rise Characteristic
Vin=Vin(nom), Full Load

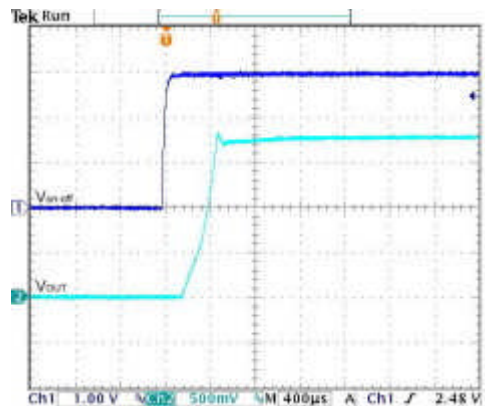

Using ON/OFF Voltage Start-Up and Vo Rise Characteristic
Vin=Vin(nom), Full Load

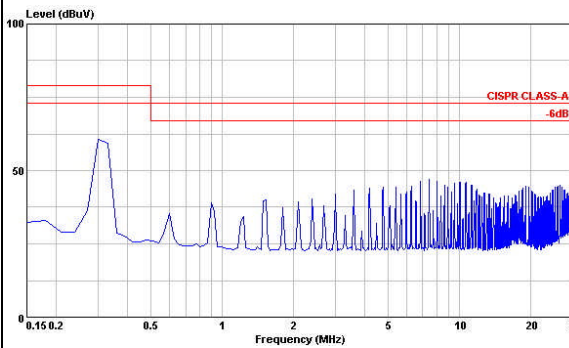

Conduction Emission of EN55022 Class A
Vin=Vin(nom), Full Load

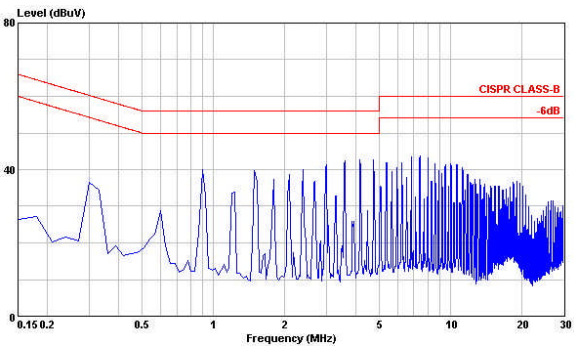

Conduction Emission of EN55022 Class B
Vin=Vin(nom), Full Load

Characteristic Curves (Continued)

All test conditions are at 25°C. The figures are for PXE30-48S2P5

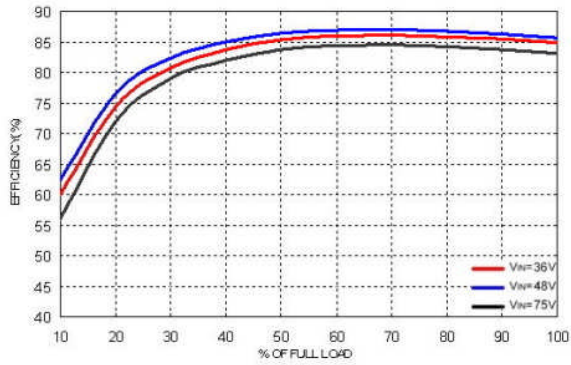

Efficiency Versus Output Current

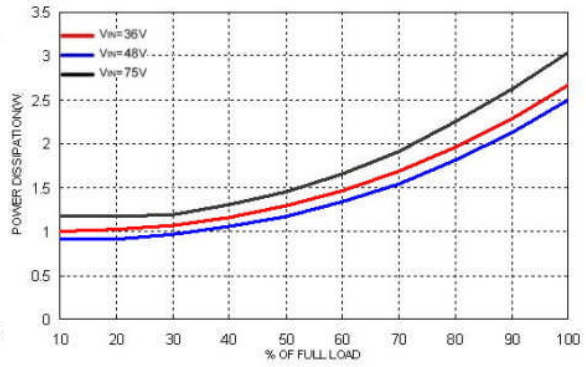

Power Dissipation Versus Output Current

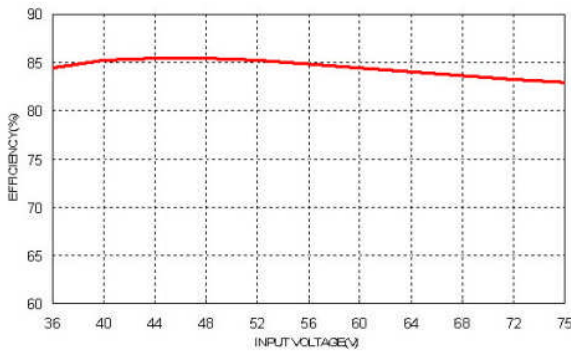

Efficiency Versus Input Voltage. Full Load

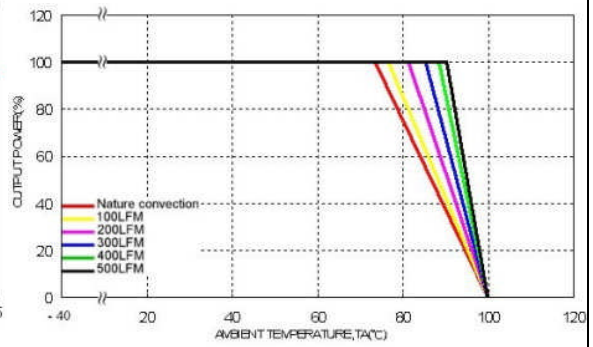

Derating Output Current Versus Ambient Temperature and Airflow
Vin=Vin(nom)

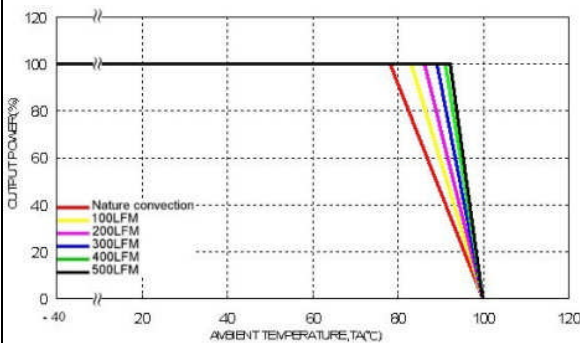

Derating Output Current Versus Ambient Temperature with Heat-Sink
and Airflow, Vin = Vin(nom)

Characteristic Curves (Continued)

All test conditions are at 25°C. The figures are for PXE30-48S2P5

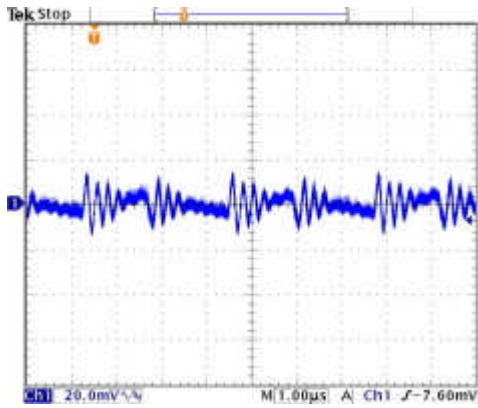

Typical Output Ripple and Noise.
Vin=Vin(nom), Full Load

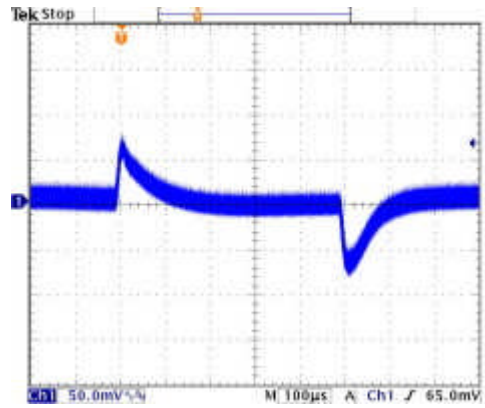

Transient Response to Dynamic Load Change from 100% to 75% to 100% of Full Load ; Vin=Vin(nom)

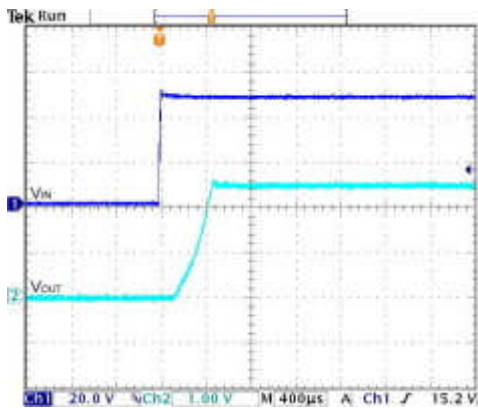

Typical Input Start-Up and Output Rise Characteristic
Vin=Vin(nom), Full Load

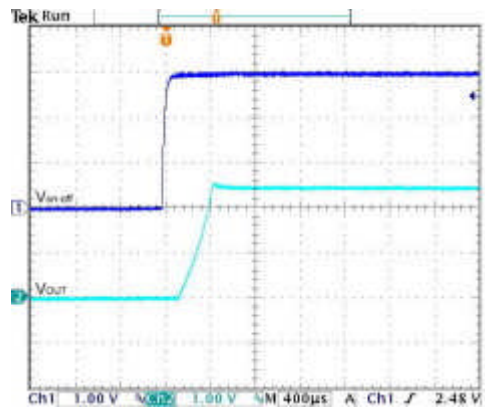

Using ON/OFF Voltage Start-Up and Vo Rise Characteristic
Vin=Vin(nom), Full Load

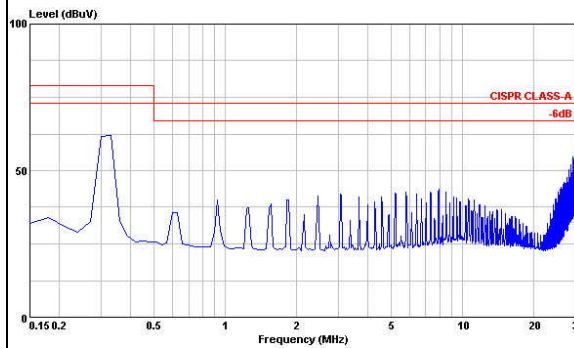

Conduction Emission of EN55022 Class A
Vin=Vin(nom), Full Load

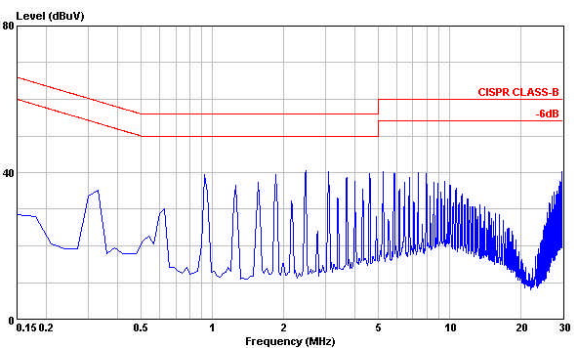

Conduction Emission of EN55022 Class B
Vin=Vin(nom), Full Load

Characteristic Curves (Continued)

All test conditions are at 25°C. The figures are for PXE30-48S3P3

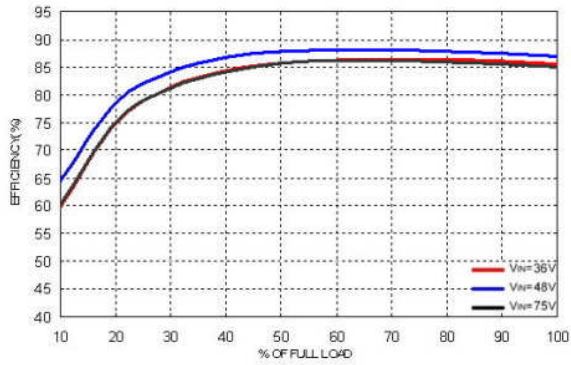

Efficiency Versus Output Current

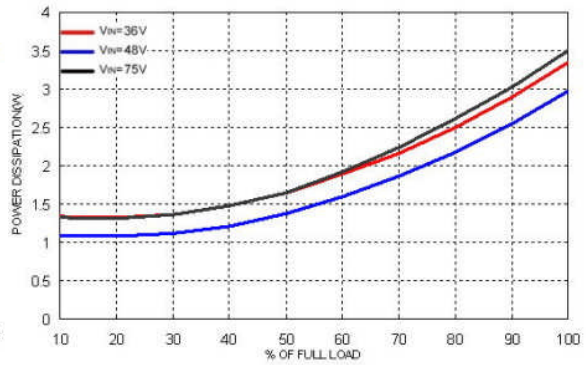

Power Dissipation Versus Output Current

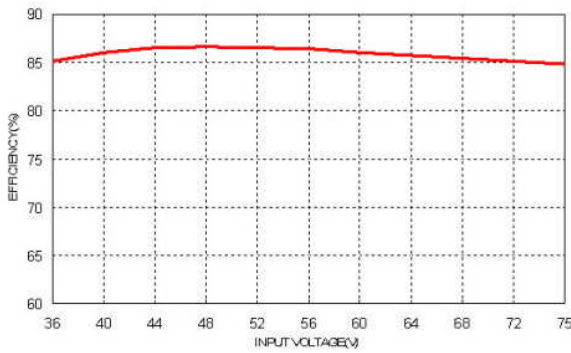

Efficiency Versus Input Voltage. Full Load

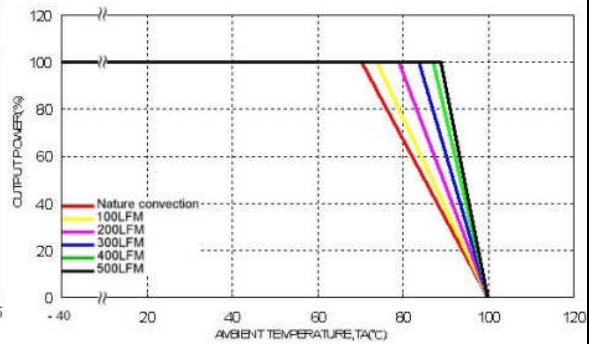

Derating Output Current Versus Ambient Temperature and Airflow
Vin=Vin(nom)

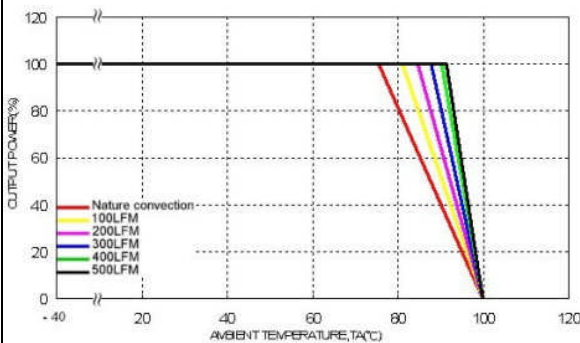

Derating Output Current Versus Ambient Temperature with Heat-Sink
and Airflow, Vin = Vin(nom)

Characteristic Curves (Continued)

All test conditions are at 25°C. The figures are for PXE30-48S3P3

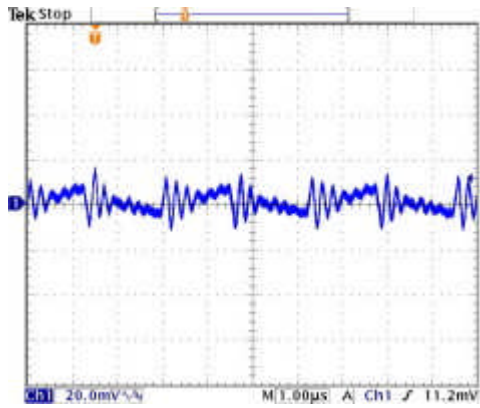

Typical Output Ripple and Noise.
Vin=Vin(nom), Full Load

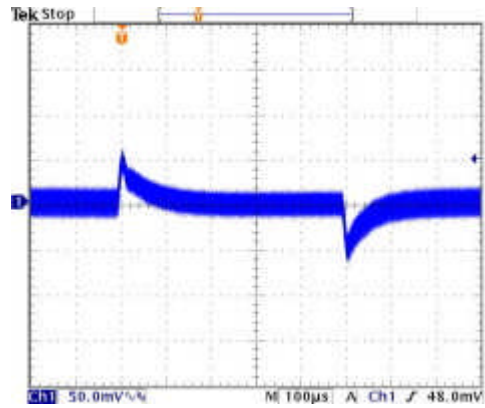

Transient Response to Dynamic Load Change from 100% to 75% to 100% of Full Load ; Vin=Vin(nom)

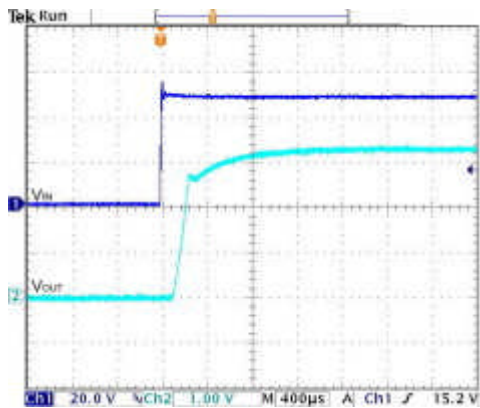

Typical Input Start-Up and Output Rise Characteristic
Vin=Vin(nom), Full Load

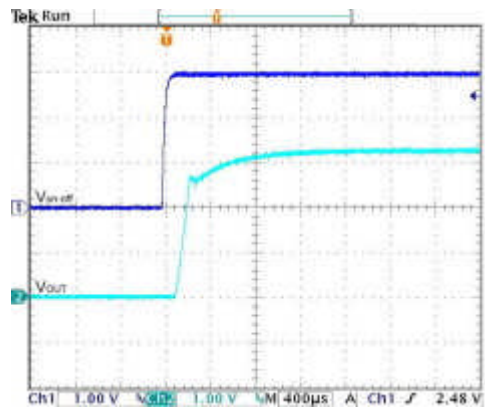

Using ON/OFF Voltage Start-Up and Vo Rise Characteristic
Vin=Vin(nom), Full Load

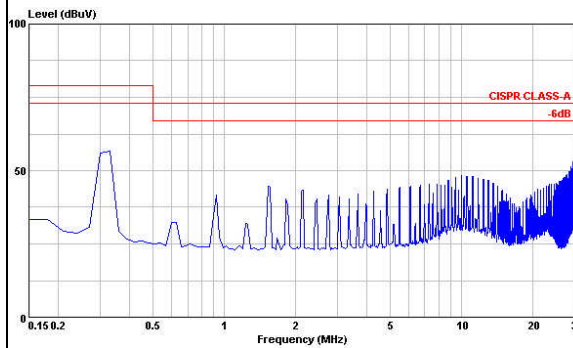

Conduction Emission of EN55022 Class A
Vin=Vin(nom), Full Load

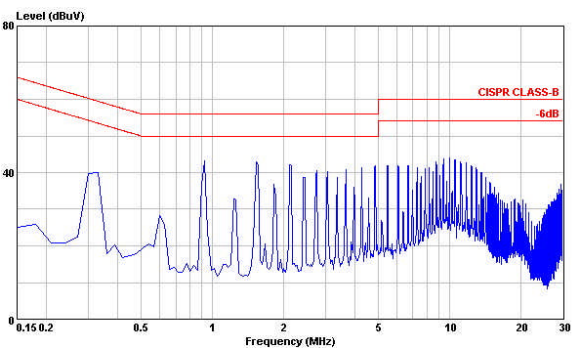

Conduction Emission of EN55022 Class B
Vin=Vin(nom), Full Load

Characteristic Curves (Continued)

All test conditions are at 25°C. The figures are for PXE30-48S05

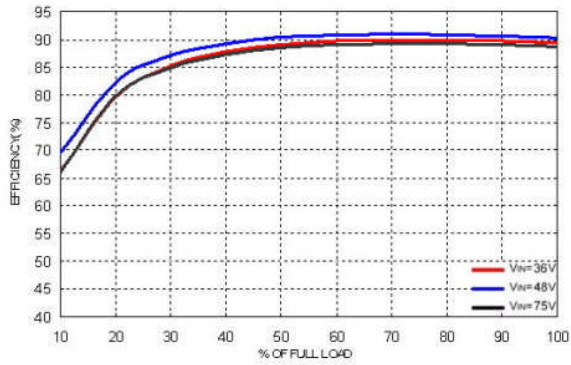

Efficiency Versus Output Current

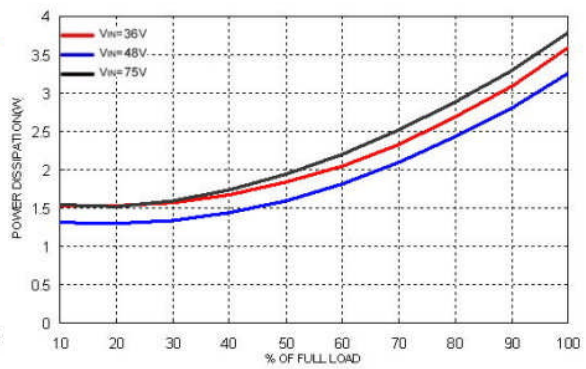

Power Dissipation Versus Output Current

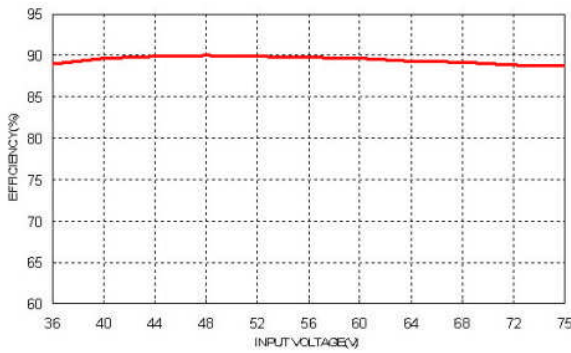

Efficiency Versus Input Voltage. Full Load

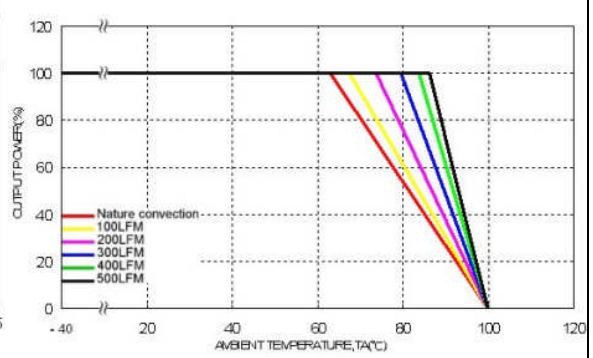

Derating Output Current Versus Ambient Temperature and Airflow
Vin=Vin(nom)

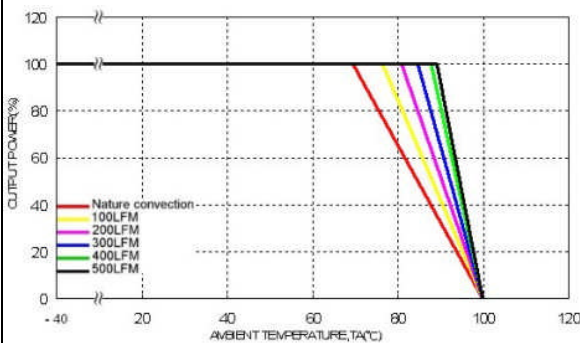

Derating Output Current Versus Ambient Temperature with Heat-Sink
and Airflow, Vin = Vin(nom)

Characteristic Curves (Continued)

All test conditions are at 25°C. The figures are for PXE30-48S05

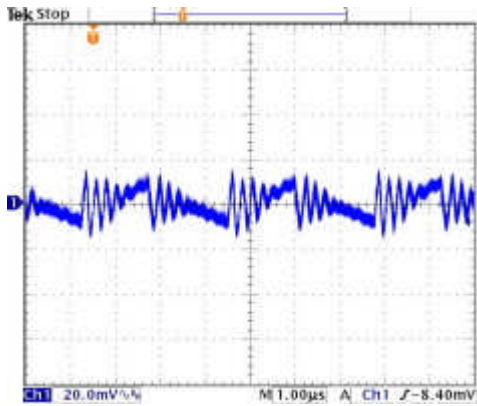

Typical Output Ripple and Noise.
Vin=Vin(nom), Full Load

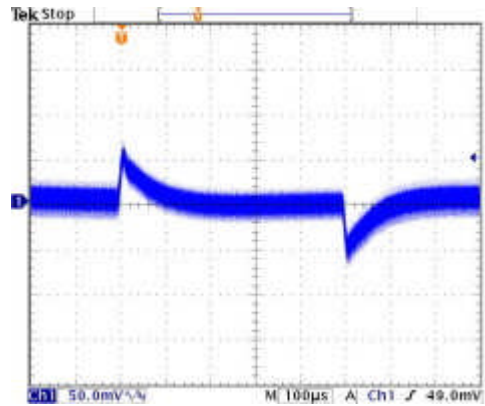

Transient Response to Dynamic Load Change from 100% to 75% to 100% of Full Load ; Vin=Vin(nom)

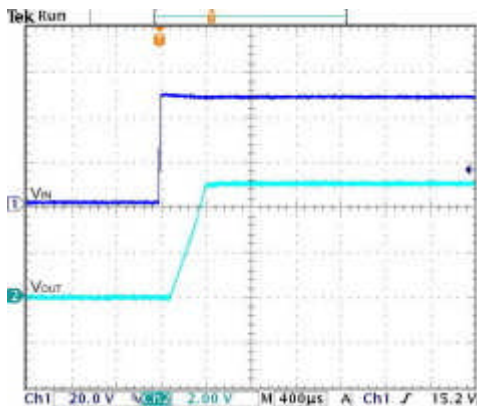

Typical Input Start-Up and Output Rise Characteristic
Vin=Vin(nom), Full Load

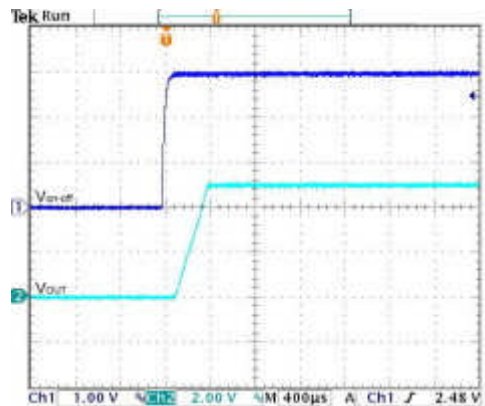

Using ON/OFF Voltage Start-Up and Vo Rise Characteristic
Vin=Vin(nom), Full Load

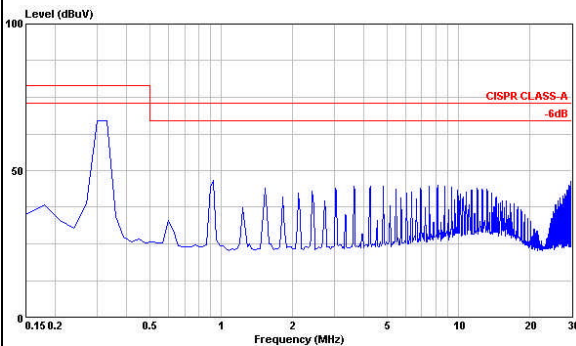

Conduction Emission of EN55022 Class A
Vin=Vin(nom), Full Load

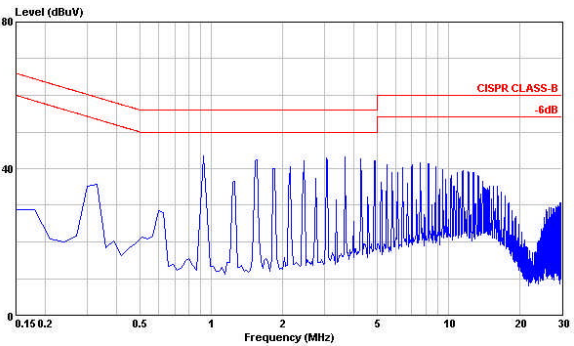

Conduction Emission of EN55022 Class B
Vin=Vin(nom), Full Load

Characteristic Curves (Continued)

All test conditions are at 25°C. The figures are for PXE30-48S12

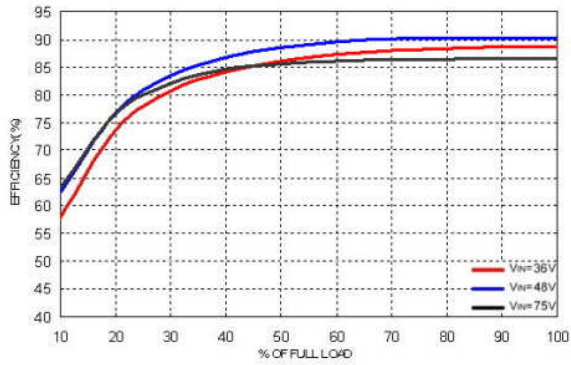

Efficiency Versus Output Current

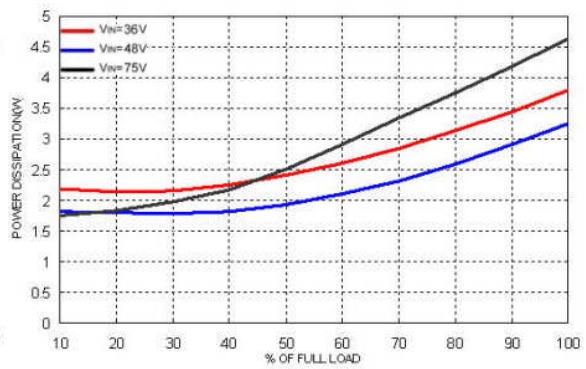

Power Dissipation Versus Output Current

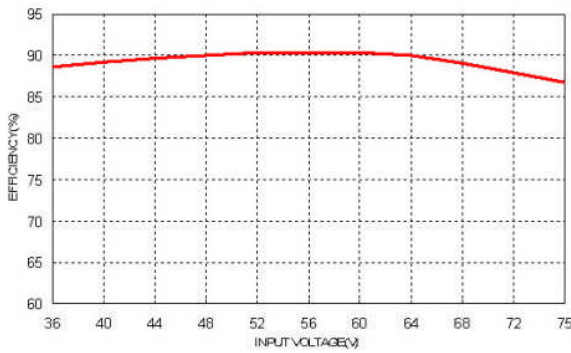

Efficiency Versus Input Voltage. Full Load

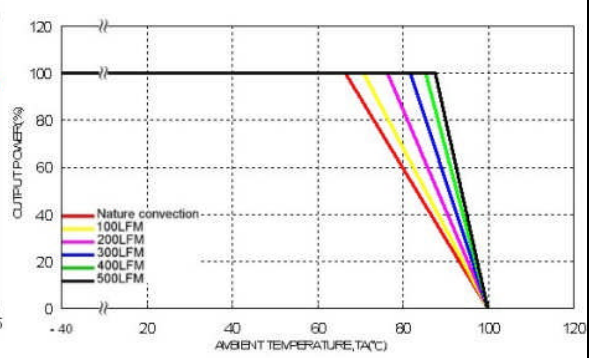

Derating Output Current Versus Ambient Temperature and Airflow
Vin=Vin(nom)

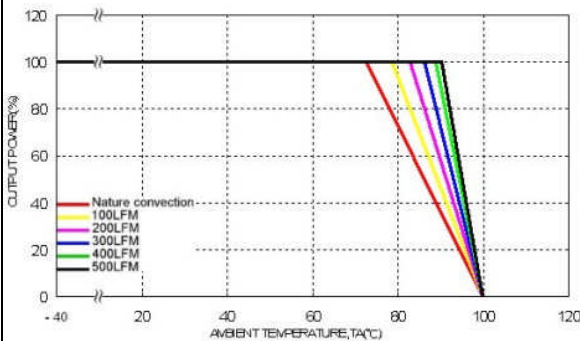

Derating Output Current Versus Ambient Temperature with Heat-Sink
and Airflow, Vin = Vin(nom)

Characteristic Curves (Continued)

All test conditions are at 25°C. The figures are for PXE30-48S12

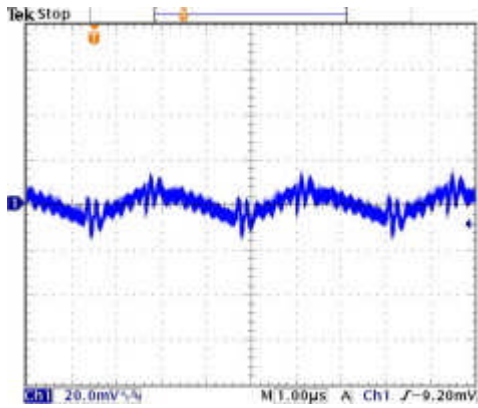

Typical Output Ripple and Noise.
Vin=Vin(nom), Full Load

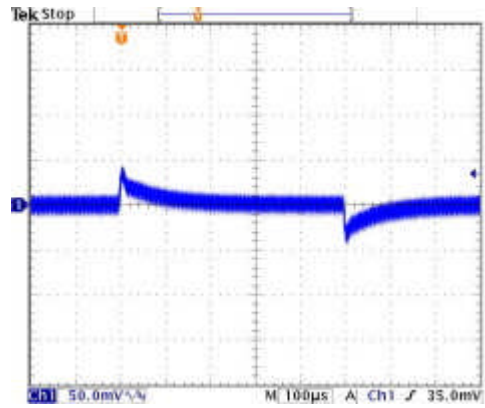

Transient Response to Dynamic Load Change from 100% to 75% to 100% of Full Load ; Vin=Vin(nom)

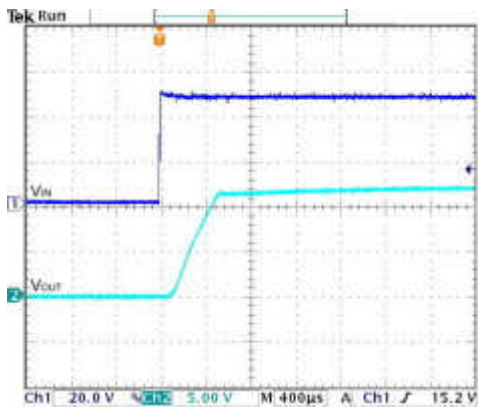

Typical Input Start-Up and Output Rise Characteristic
Vin=Vin(nom), Full Load

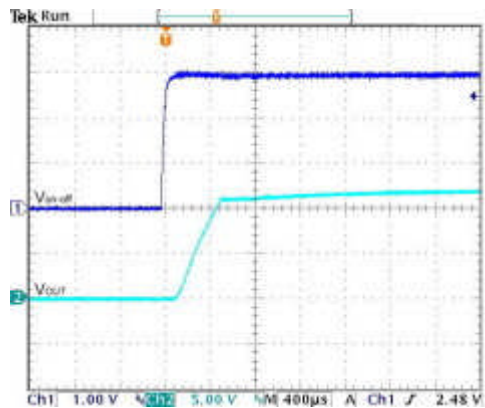

Using ON/OFF Voltage Start-Up and Vo Rise Characteristic
Vin=Vin(nom), Full Load

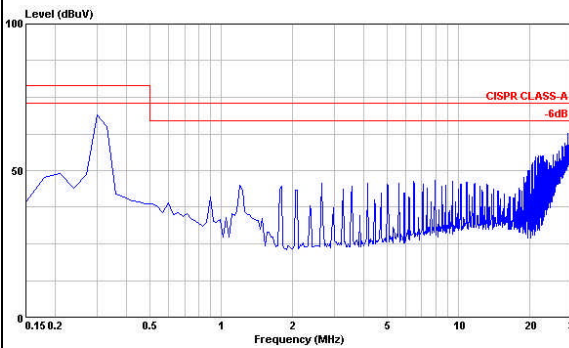

Conduction Emission of EN55022 Class A
Vin=Vin(nom), Full Load

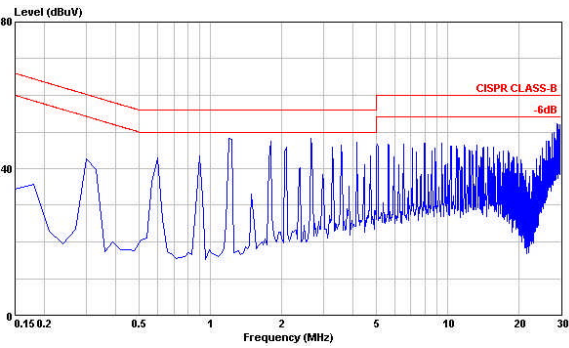

Conduction Emission of EN55022 Class B
Vin=Vin(nom), Full Load

Characteristic Curves (Continued)

All test conditions are at 25°C. The figures are for PXE30-48S15

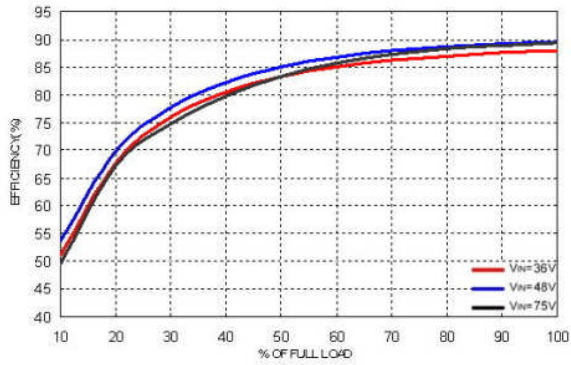

Efficiency Versus Output Current

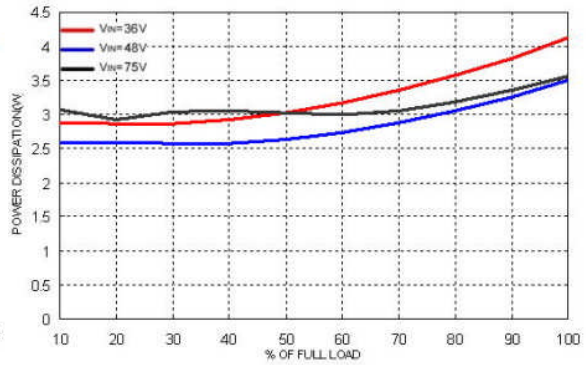

Power Dissipation Versus Output Current

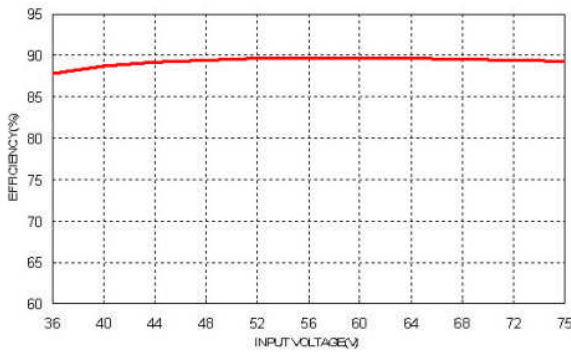

Efficiency Versus Input Voltage. Full Load

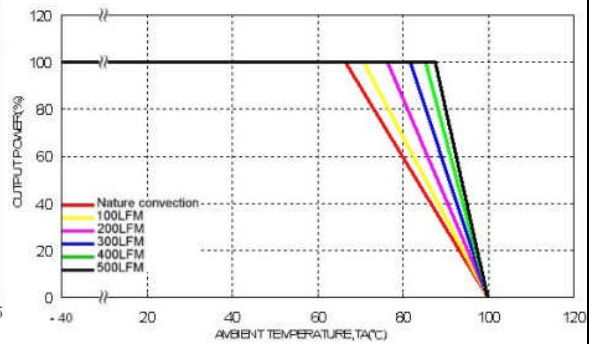

Derating Output Current Versus Ambient Temperature and Airflow
Vin=Vin(nom)

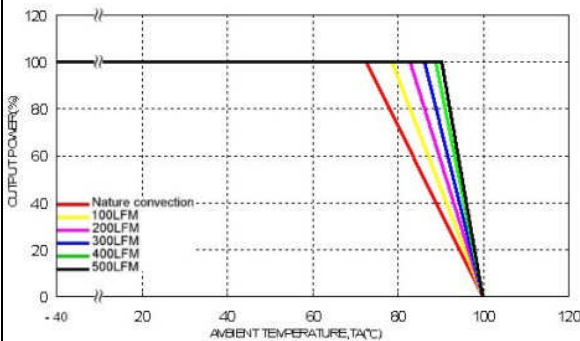

Derating Output Current Versus Ambient Temperature with Heat-Sink
and Airflow, Vin = Vin(nom)

Characteristic Curves (Continued)

All test conditions are at 25°C. The figures are for PXE30-48S15

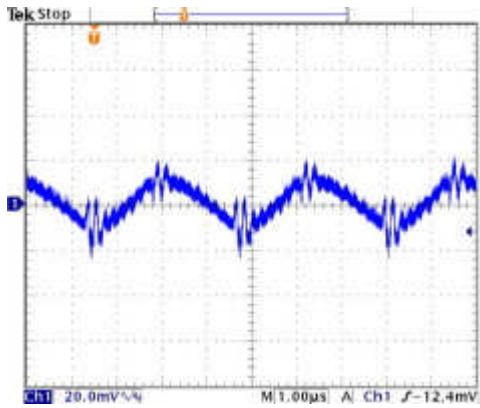

Typical Output Ripple and Noise.
Vin=Vin(nom), Full Load

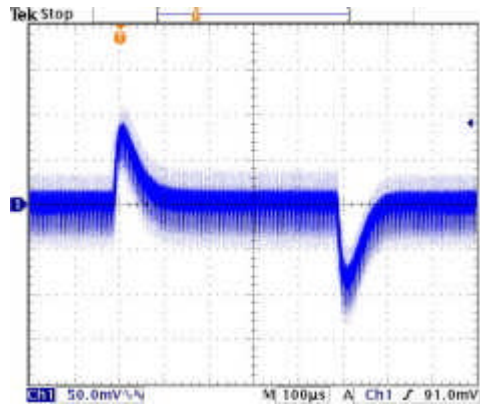

Transient Response to Dynamic Load Change from 100% to 75% to 100% of Full Load ; Vin=Vin(nom)

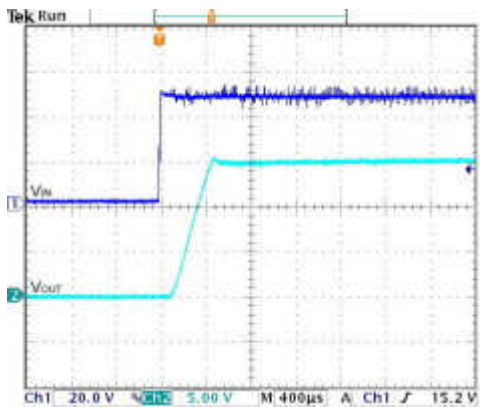

Typical Input Start-Up and Output Rise Characteristic
Vin=Vin(nom), Full Load

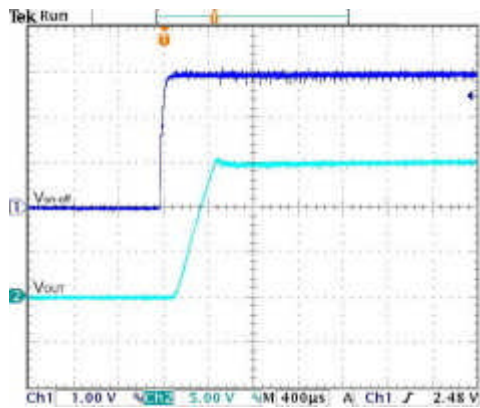

Using ON/OFF Voltage Start-Up and Vo Rise Characteristic
Vin=Vin(nom), Full Load

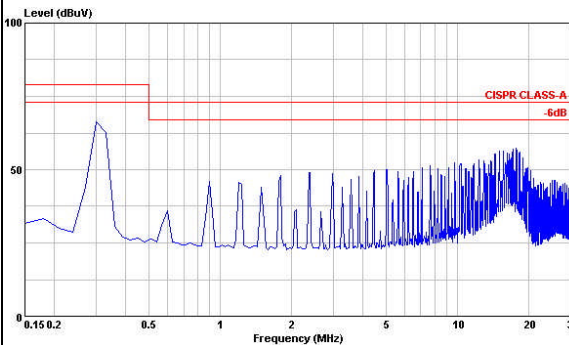

Conduction Emission of EN55022 Class A
Vin=Vin(nom), Full Load

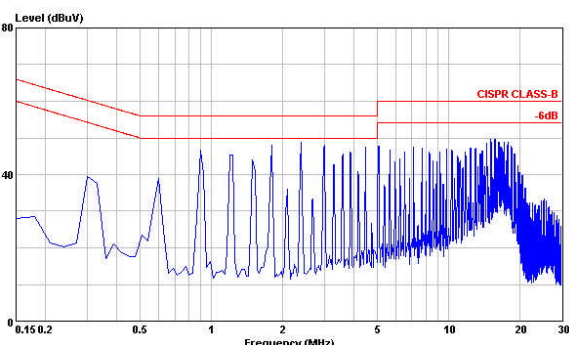

Conduction Emission of EN55022 Class B
Vin=Vin(nom), Full Load

Test Configurations

Input reflected-ripple current measurement test:

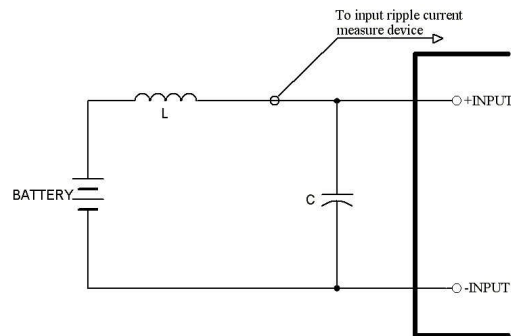

Component	Value	Voltage	Reference
L	12 μ H	---	---
C	220 μ F	100V	Aluminum Electrolytic Capacitor

Peak-to-peak output ripple & noise measurement test:

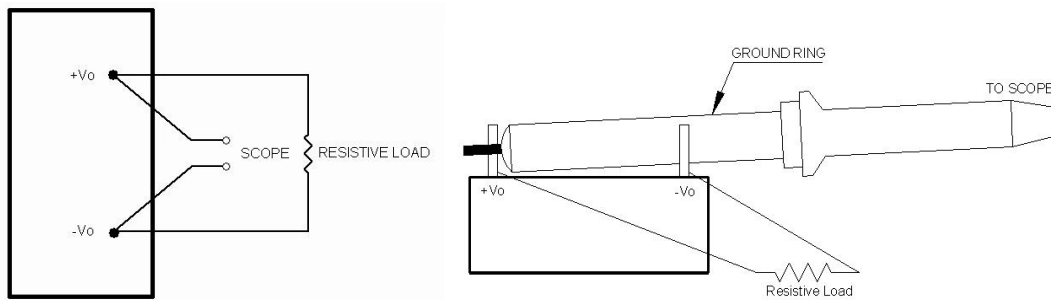

Output voltage and efficiency measurement test:

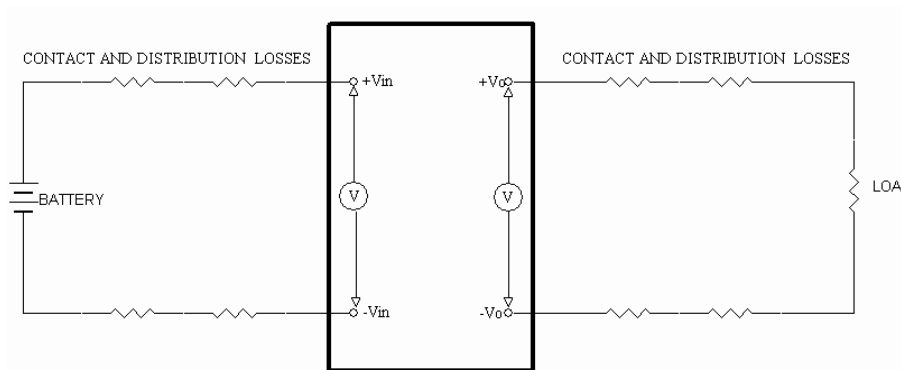

Note: All measurements are taken at the module terminals.

$$Efficiency = \left(\frac{V_o \times I_o}{V_{in} \times I_{in}} \right) \times 100\%$$

EMC Considerations

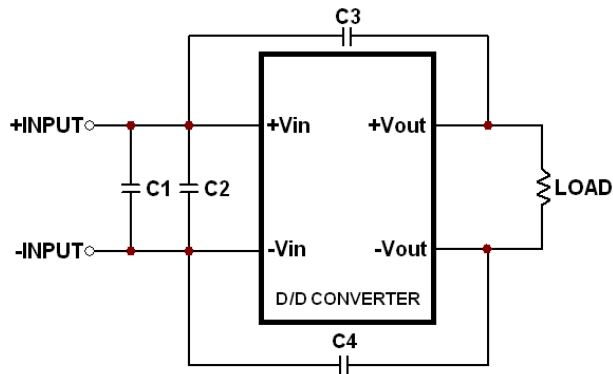

Suggested Schematic for EN55022 Conducted Emission Class A Limits

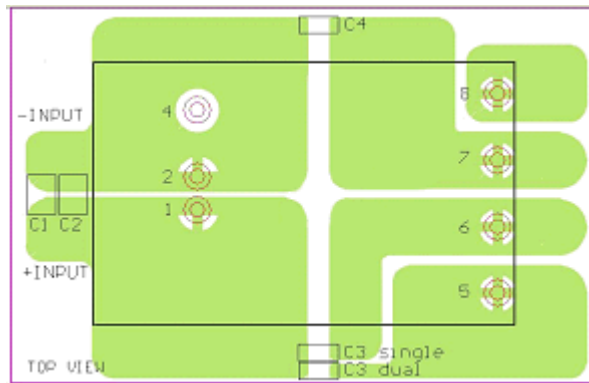

Recommended Layout with Input Filter

To meet conducted emissions EN55022 CLASS A needed the following components:

PXE30-12Sxx

Component	Value	Voltage	Reference
C1	6.8μF	50V	1812 MLCC
C3, C4	1000pF	2KV	1808 MLCC

PXE30-24Sxx

Component	Value	Voltage	Reference
C1	6.8μF	50V	1812 MLCC
C3, C4	1000pF	2KV	1808 MLCC

PXE30-48Sxx

Component	Value	Voltage	Reference
C1	2.2μF	100V	1812 MLCC
C3, C4	1000pF	2KV	1808 MLCC

EMC Considerations (Continued)

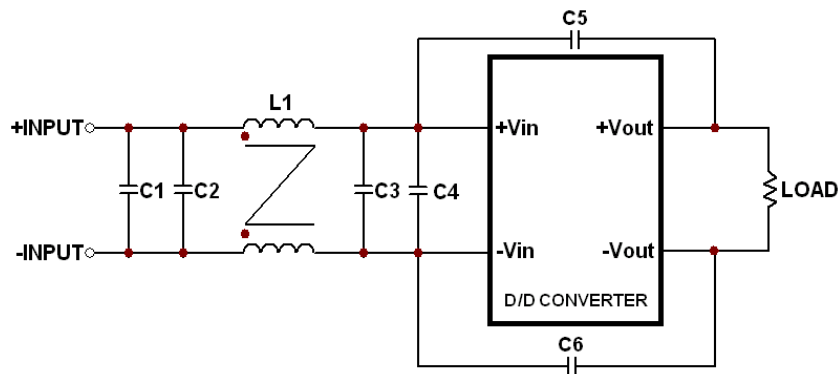

Suggested Schematic for EN55022 Conducted Emission Class B Limits

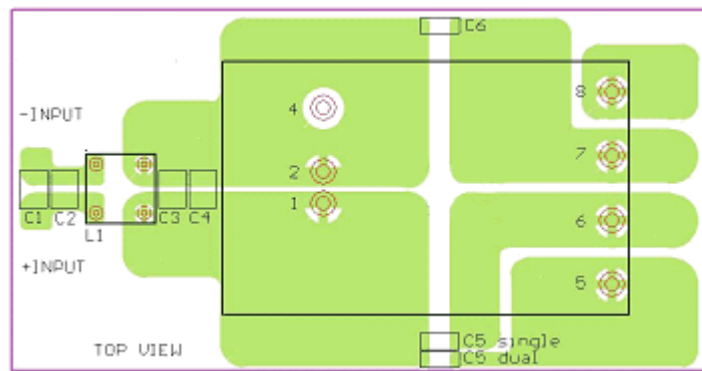

Recommended Layout with Input Filter

To meet conducted emissions EN55022 CLASS B needed the following components:

PXE30-12Sxx

Component	Value	Voltage	Reference
C1, C3	4.7 μ F	50V	1812 MLCC
C5, C6	1000pF	2KV	1808 MLCC
L1	450 μ H	----	Common Choke

PXE30-24Sxx

Component	Value	Voltage	Reference
C1, C3	6.8 μ F	50V	1812 MLCC
C5, C6	1000pF	2KV	1808 MLCC
L1	450 μ H	----	Common Choke

PXE30-48Sxx

Component	Value	Voltage	Reference
C1, C2	2.2 μ F	100V	1812 MLCC
C3, C4	2.2 μ F	100V	1812 MLCC
C5, C6	1000pF	2KV	1808 MLCC
L1	450 μ H	----	Common Choke

EMC Considerations (Continued)

Common Choke L1 is defined as follows:

- L: $450\mu\text{H}\pm 35\%$ / DCR: $25\text{m}\Omega$, max
- A height: 9.8 mm, Max
- All dimensions in millimeters

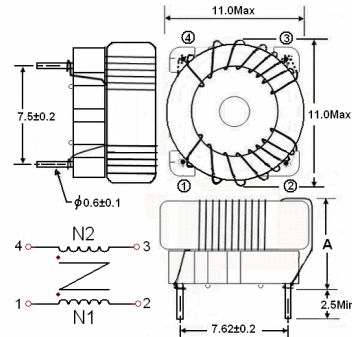

Input Source Impedance

The converter should be connected to a low impedance input source. Highly inductive source impedance can affect the stability of the converter. An input external L-C filter is recommended to minimize input reflected ripple current. The inductor has a simulated source impedance of $12\mu\text{H}$ and the capacitor is Nippon chemi-con KY series $220\mu\text{F}/100\text{V}$. The capacitor must be located as close as possible to the input terminals of the power module for lowest impedance.

Output Over Current Protection

When excessive output currents occur in the system, circuit protection is required on all converters. Normally, overload current is maintained at approximately 150 percent of rated current for PXF40-xxSxx series.

Hiccup-mode is a method of operation in a converter whose purpose is to protect the power supply from being damaged during an over-current fault condition. It also enables the converter to restart when the fault is removed. There are other ways of protecting the converter when it is over-loaded, such as the maximum current limiting or current foldback methods.

One of the problems resulting from over current is that excessive heat may be generated in power devices; especially MOSFET and Schottky diodes and the temperature of these devices may exceed their specified limits. A protection mechanism has to be used to prevent these power devices from being damaged.

The operation of hiccup is as follows. When the current sense circuit sees an over-current event, the controller shuts off the converter for a given time and then tries to start up the converter again. If the over-load condition has been removed, the converter will start up and operate normally; otherwise, the controller will see another over-current event and will shut off the converter again, repeating the previous cycle. Hiccup operation has none of the drawbacks of the other two protection methods, although its circuit is more complicated because it requires a timing circuit. The excess heat due to overload lasts for only a short duration in the hiccup cycle, hence the junction temperature of the power devices is much lower.

Output Over Voltage Protection

The output over-voltage protection consists of an output Zener diode that monitors the voltage on the output terminals. If the voltage on the output terminals exceeds the over-voltage protection threshold, then the Zener diode clamps the output voltage.

Short Circuit Protection

Continuous, hiccup and auto-recovery mode.

During a short circuit condition the converter will shut down. The average current during this condition will be very low.

Thermal Consideration

The converter operates in a variety of thermal environments. However, sufficient cooling should be provided to help ensure reliable operation of the unit. Heat is removed by conduction, convection, and radiation to the surrounding environment. Proper cooling can be verified by measuring the point as the figure below. The temperature at this location should not exceed 100°C. When operating, adequate cooling must be provided to maintain the test point temperature at or below 100°C. Although the maximum point temperature of the converter is 100°C, limiting this temperature to a lower value will yield higher reliability.

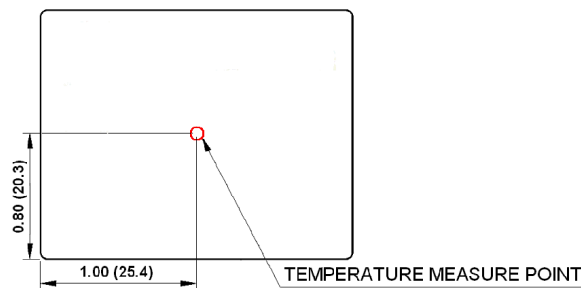

Heat Sink Consideration

Use heat-sink (7G-0011C-F) for lowering temperature and higher reliability of the module.

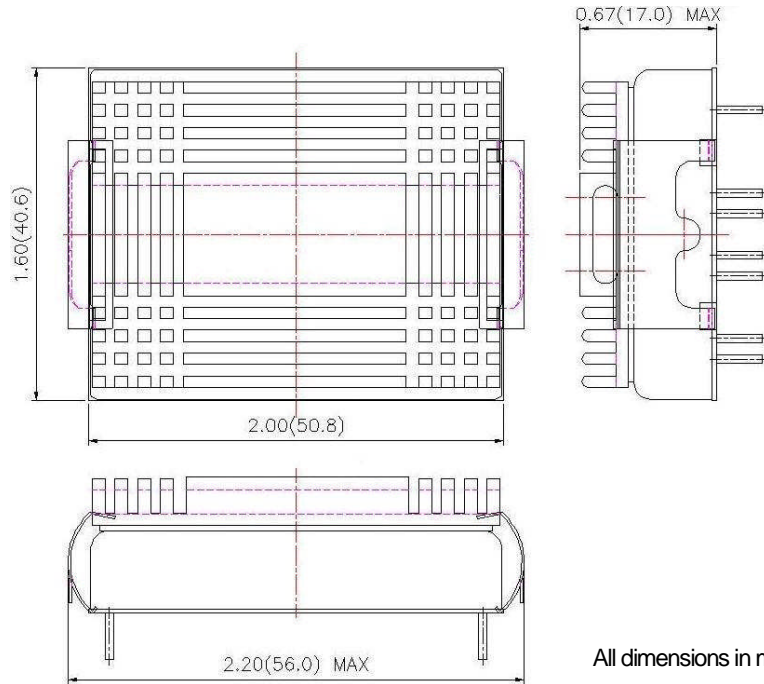

All dimensions in millimeters

Remote ON/OFF Control

The Remote ON/OFF Pin is used to turn on and off the DC-DC converter. The user must use a switch to control the logic voltage (high or low level) of the ON/OFF pin, referenced to $-V_i$. The switch can be an open collector transistor, FET or Opto-Coupler that is capable of sinking up to 0.5 mA at low-level logic Voltage. High-level logic of the ON/OFF signal (maximum voltage): the allowable leakage current of the switch at 12V is 0.5mA.

Remote ON/OFF Implementation Circuits

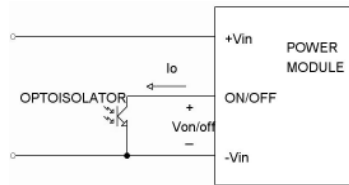

Isolated-Control Remote ON/OFF

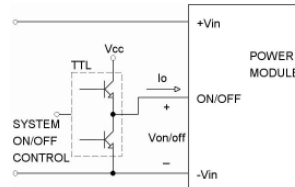

Level Control Using TTL Output

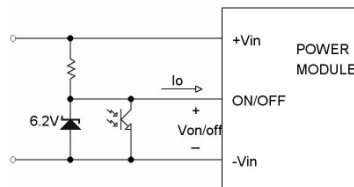

Level Control Using Line Voltage

Positive logic:

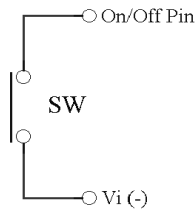

PXE30 module is turned off
Using Low-level logic

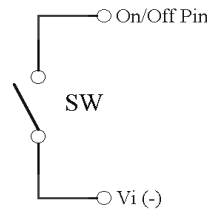

PXE30 module is turned on
using High-level logic

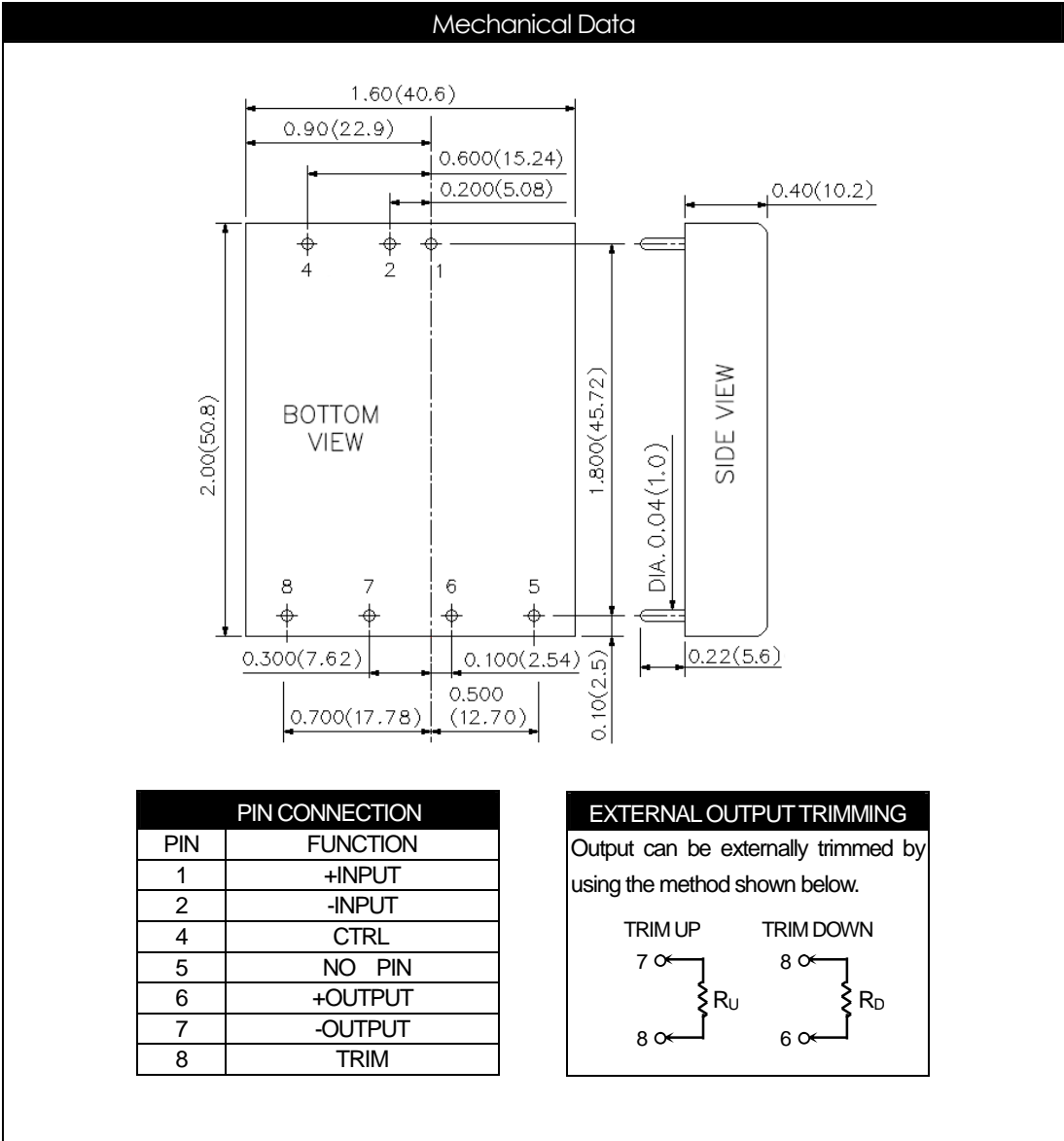

Output Voltage Adjustment

Output voltage set point adjustment allows the user to increase or decrease the output voltage set point of a module. This is accomplished by connecting an external resistor between the TRIM pin and either the Vo(+) or Vo(-) pins. With an external resistor between the TRIM and Vo(-) pin, the output voltage set point increases. With an external resistor between the TRIM and Vo(+) pin, the output voltage set point decreases.

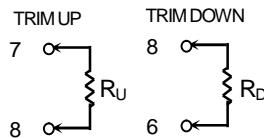

TRIM TABLE

PXE30-xxS1P5

Trim up (%)	1	2	3	4	5	6	7	8	9	10
V_{OUT} (Volts)=	1.515	1.53	1.545	1.56	1.575	1.59	1.605	1.62	1.635	1.65
R_U (K OhmS)=	4.578	2.605	1.227	0.808	0.557	0.389	0.27	0.18	0.11	0.054
Trim down (%)	1	2	3	4	5	6	7	8	9	10
V_{OUT} (Volts)=	1.485	1.47	1.455	1.44	1.425	1.41	1.395	1.38	1.365	1.35
R_D (K OhmS)=	5.704	2.571	1.527	1.005	0.692	0.483	0.334	0.222	0.135	0.065

PXE30-xxS1P8

Trim up (%)	1	2	3	4	5	6	7	8	9	10
V_{OUT} (Volts)=	1.818	1.836	1.854	1.872	1.89	1.908	1.926	1.944	1.962	1.98
R_U (K OhmS)=	11.639	5.205	3.06	1.988	1.344	0.915	0.609	0.379	0.2	0.057
Trim down (%)	1	2	3	4	5	6	7	8	9	10
V_{OUT} (Volts)=	1.782	1.764	1.746	1.728	1.71	1.692	1.674	1.656	1.638	1.62
R_D (K OhmS)=	14.66	6.57	3.874	2.525	1.716	1.177	0.792	0.503	0.278	0.098

PXE30-xxS2P5

Trim up (%)	1	2	3	4	5	6	7	8	9	10
V_{OUT} (Volts)=	2.525	2.55	2.575	2.6	2.625	2.65	2.675	2.7	2.725	2.75
R_U (K OhmS)=	37.076	16.675	9.874	6.474	4.434	3.074	2.102	1.374	0.807	0.354
Trim down (%)	1	2	3	4	5	6	7	8	9	10
V_{OUT} (Volts)=	2.475	2.45	2.425	2.4	2.375	2.35	2.325	2.3	2.275	2.25
R_D (K OhmS)=	49.641	22.481	13.428	8.902	6.186	4.375	3.082	2.112	1.358	0.754

PXE30-xxS3P3

Trim up (%)	1	2	3	4	5	6	7	8	9	10
V_{OUT} (Volts)=	3.333	3.366	3.399	3.432	3.465	3.498	3.531	3.564	3.597	3.630
R_U (K OhmS)=	57.930	26.165	15.577	10.283	7.106	4.988	3.476	2.341	1.459	0.753
Trim down (%)	1	2	3	4	5	6	7	8	9	10
V_{OUT} (Volts)=	3.267	3.234	3.201	3.168	3.135	3.102	3.069	3.036	3.003	2.970
R_D (K OhmS)=	69.470	31.235	18.490	12.117	8.294	5.745	3.924	2.559	1.497	0.647

Output Voltage Adjustment(Continued)

PXE30-xxS05

Trim up (%)	1	2	3	4	5	6	7	8	9	10
V _{OUT} (Volts)=	5.050	5.100	5.150	5.200	5.250	5.300	5.350	5.400	5.450	5.500
R _U (K OhmS)=	36.570	16.580	9.917	6.585	4.586	3.253	2.302	1.588	1.032	0.588
Trim down (%)	1	2	3	4	5	6	7	8	9	10
V _{OUT} (Volts)=	4.950	4.900	4.850	4.800	4.750	4.700	4.650	4.600	4.550	4.500
R _D (K OhmS)=	45.533	20.612	12.306	8.152	5.660	3.999	2.812	1.922	1.230	0.676

PXE30-xxS12

Trim up (%)	1	2	3	4	5	6	7	8	9	10
V _{OUT} (Volts)=	12.120	12.240	12.360	12.480	12.600	12.720	12.840	12.960	13.080	13.200
R _U (K OhmS)=	367.910	165.950	98.636	64.977	44.782	31.318	21.701	14.488	8.879	4.391
Trim down (%)	1	2	3	4	5	6	7	8	9	10
V _{OUT} (Volts)=	11.880	11.760	11.640	11.520	11.400	11.280	11.160	11.040	10.920	10.800
R _D (K OhmS)=	460.990	207.950	123.600	81.423	56.118	39.249	27.199	18.162	11.132	5.509

PXE30-xxS15

Trim up (%)	1	2	3	4	5	6	7	8	9	10
V _{OUT} (Volts)=	15.150	15.300	15.450	15.600	15.750	15.900	16.050	16.200	16.350	16.500
R _U (K OhmS)=	404.180	180.590	106.060	68.796	46.437	31.531	20.883	12.898	6.687	1.718
Trim down (%)	1	2	3	4	5	6	7	8	9	10
V _{OUT} (Volts)=	14.850	14.700	14.550	14.400	14.250	14.100	13.950	13.800	13.650	13.500
R _D (K OhmS)=	499.820	223.410	131.270	85.204	57.563	39.136	25.974	16.102	8.424	2.282

Soldering and Reflow Consideration

Lead free wave solder profile for PXE30-xxSxx DIP type

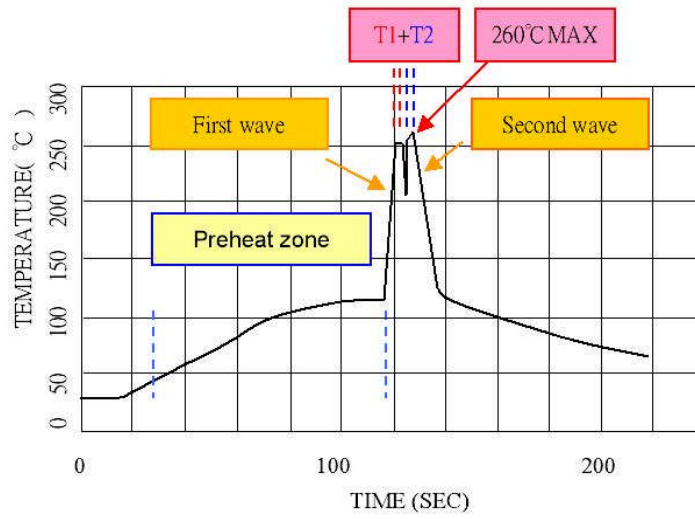

Zone	Reference Parameter
Preheat zone	Rise temp. speed : 3°C / sec max. Preheat temp. : 100~130°C
Actual heating	Peak temp. : 250~260°C Peak time (T1+T2 time) : 4~6 sec

Reference Solder: Sn-Ag-Cu / Sn-Cu

Hand Welding: Soldering iron - Power 90W

Welding Time: 2-4 sec

Temp.:380-400 °C

Packaging Information

12 PCS per TUBE

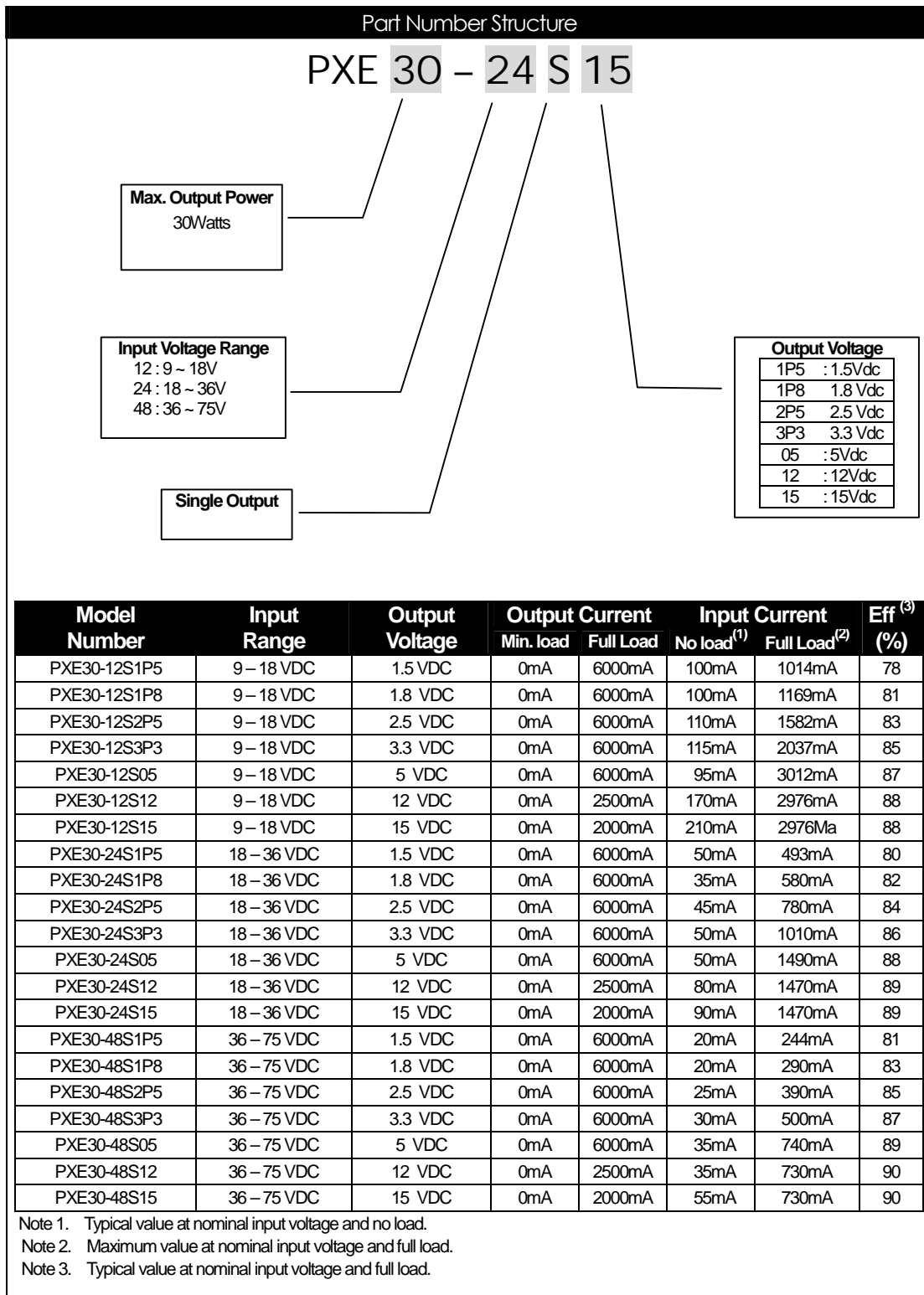

Safety and Installation Instruction**Fusing Consideration**

Caution: This converter is not internally fused. An input line fuse must always be used.

This encapsulated converter can be used in a wide variety of applications, ranging from simple stand-alone operation to an integrated part of a sophisticated power architecture. For maximum flexibility, internal fusing is not included; however, to achieve maximum safety and system protection, always use an input line fuse. The safety agencies require a slow-blow fuse with maximum rating of 6A. Based on the information provided in this data sheet on Inrush energy and maximum DC input current; the same type of fuse with lower rating can be used. Refer to the fuse manufacturer's data for further information.

MTBF and Reliability**The MTBF of PXE30-xxSxx DC/DC converters has been calculated using:**

Bellcore TR-NWT-000332 Case I: 50% stress, Operating Temperature at 40°C (Ground fixed and controlled environment). The resulting figure for MTBF is 1.316×10^6 hours.

MIL-HDBK-217F NOTICE2 FULL LOAD, Operating Temperature at 25°C °C. The resulting figure for MTBF is 3.465×10^5 hours.