

Hyperfast Rectifier, 30 A FRED Pt™

FEATURES

- Hyperfast recovery time
- Low forward voltage drop
- Low leakage current
- 175 °C operating junction temperature
- Single diode device
- Designed and qualified for industrial level

DESCRIPTION/APPLICATIONS

State of the art hyperfast recovery rectifiers designed with optimized performance of forward voltage drop, hyperfast recovery time and soft recovery.

The planar structure and the platinum doped life time control guarantee the best overall performance, ruggedness and reliability characteristics.

These devices are intended for use in PFC boost stage in the AC-DC section of SMPS, inverters or as freewheeling diodes.

Their extremely optimized stored charge and low recovery current minimize the switching losses and reduce over dissipation in the switching element and snubbers.



TO-247AC modified

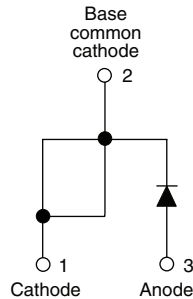

PRODUCT SUMMARY	
t_{rr} (typical)	28 ns
$I_{F(AV)}$	30 A
V_R	600 V

ABSOLUTE MAXIMUM RATINGS				
PARAMETER	SYMBOL	TEST CONDITIONS	VALUES	UNITS
Peak repetitive reverse voltage	V_{RRM}		600	V
Average rectified forward current	$I_{F(AV)}$	$T_C = 116\text{ °C}$	30	A
Non-repetitive peak surge current	I_{FSM}	$T_J = 25\text{ °C}$	300	
Operating junction and storage temperatures	T_J, T_{Stg}		- 65 to 175	°C

ELECTRICAL SPECIFICATIONS ($T_J = 25\text{ °C}$ unless otherwise specified)						
PARAMETER	SYMBOL	TEST CONDITIONS	MIN.	TYP.	MAX.	UNITS
Breakdown voltage, blocking voltage	V_{BR}, V_R	$I_R = 100\ \mu\text{A}$	600	-	-	V
Forward voltage	V_F	$I_F = 30\ \text{A}$	-	2.0	2.6	V
		$I_F = 30\ \text{A}, T_J = 150\text{ °C}$	-	1.34	1.75	
Reverse leakage current	I_R	$V_R = V_R$ rated	-	0.3	50	μA
		$T_J = 150\text{ °C}, V_R = V_R$ rated	-	60	500	
Junction capacitance	C_T	$V_R = 600\ \text{V}$	-	33	-	pF
Series inductance	L_S	Measured lead to lead 5 mm from package body	-	3.5	-	nH

DYNAMIC RECOVERY CHARACTERISTICS ($T_J = 25\text{ }^\circ\text{C}$ unless otherwise specified)							
PARAMETER	SYMBOL	TEST CONDITIONS	MIN.	TYP.	MAX.	UNITS	
Reverse recovery time	t_{rr}	$I_F = 1.0\text{ A}$, $di_F/dt = 50\text{ A}/\mu\text{s}$, $V_R = 30\text{ V}$	-	28	35	ns	
		$T_J = 25\text{ }^\circ\text{C}$	-	31	-		
		$T_J = 125\text{ }^\circ\text{C}$	-	77	-		
Peak recovery current	I_{RRM}	$I_F = 30\text{ A}$ $di_F/dt = 200\text{ A}/\mu\text{s}$ $V_R = 200\text{ V}$	$T_J = 25\text{ }^\circ\text{C}$	-	3.5	-	A
			$T_J = 125\text{ }^\circ\text{C}$	-	7.7	-	
Reverse recovery charge	Q_{rr}	$I_F = 30\text{ A}$ $di_F/dt = 200\text{ A}/\mu\text{s}$ $V_R = 200\text{ V}$	$T_J = 25\text{ }^\circ\text{C}$	-	65	-	nC
			$T_J = 125\text{ }^\circ\text{C}$	-	345	-	

THERMAL - MECHANICAL SPECIFICATIONS						
PARAMETER	SYMBOL	TEST CONDITIONS	MIN.	TYP.	MAX.	UNITS
Maximum junction and storage temperature range	T_J, T_{Stg}		- 65	-	175	$^\circ\text{C}$
Thermal resistance, junction to case per leg	R_{thJC}		-	0.5	0.9	$^\circ\text{C}/\text{W}$
Thermal resistance, junction to ambient per leg	R_{thJA}	Typical socket mount	-	-	70	
Thermal resistance, case to heatsink	R_{thCS}	Mounting surface, flat, smooth and greased	-	0.4	-	
Weight			-	6.0	-	g
			-	0.22	-	oz.
Mounting torque			6.0 (5.0)	-	12 (10)	kgf · cm (lbf · in)
Marking device		Case style TO-247AC modified	30EPH06			

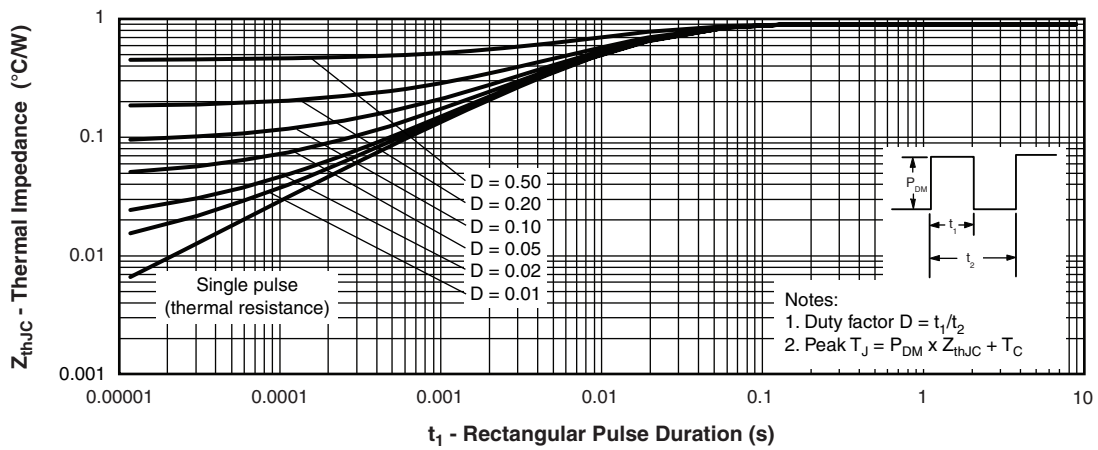
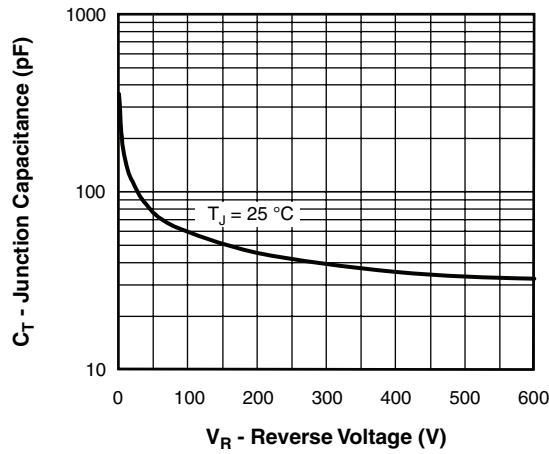
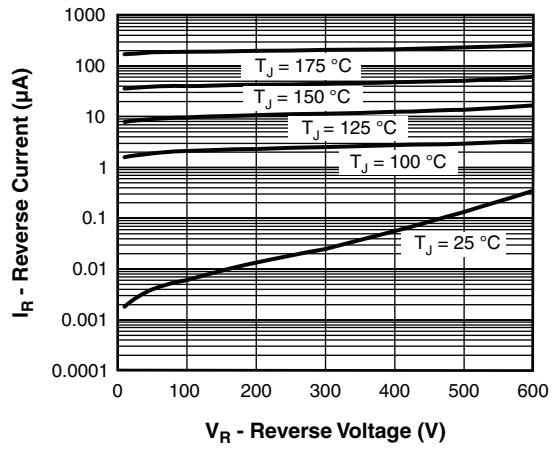
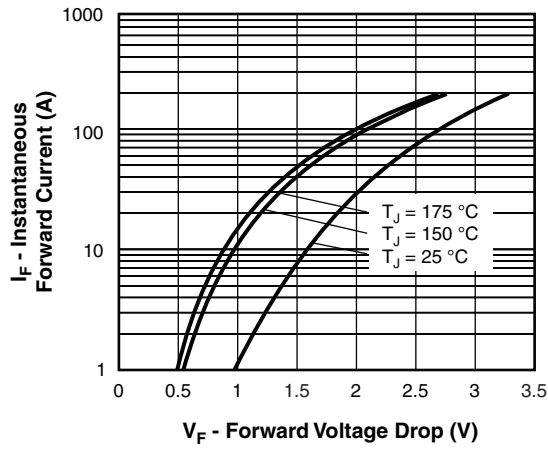

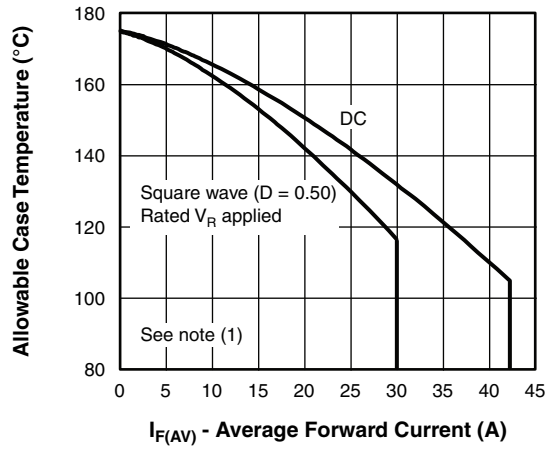

Fig. 5 - Maximum Allowable Case Temperature vs. Average Forward Current

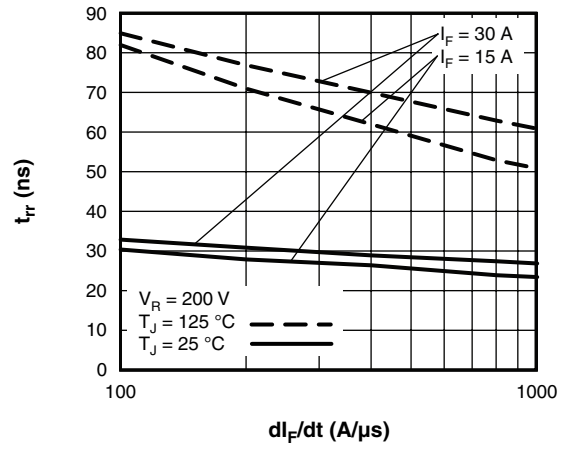

Fig. 7 - Typical Reverse Recovery Time vs. di_F/dt

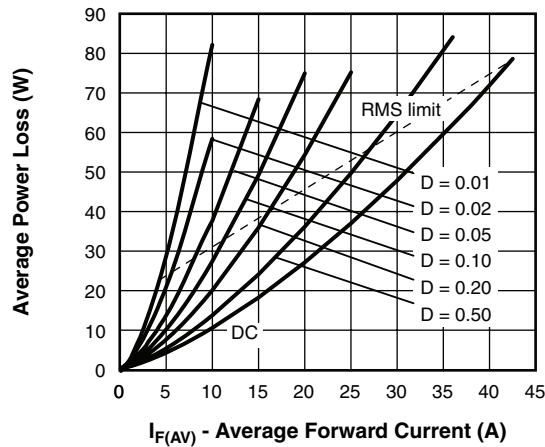

Fig. 6 - Forward Power Loss Characteristics

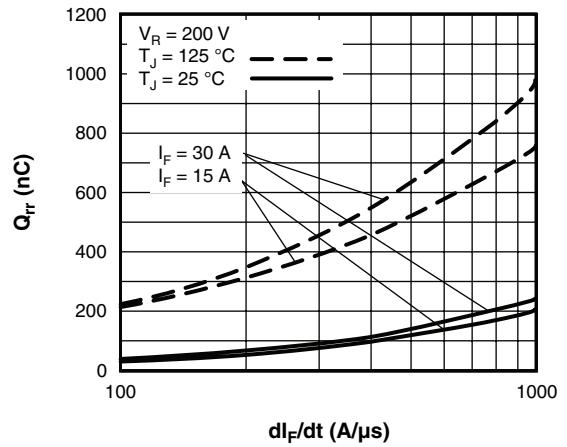

Fig. 8 - Typical Stored Charge vs. di_F/dt

Note

- (1) Formula used: $T_C = T_J - (Pd + Pd_{REV}) \times R_{thJC}$;
 Pd = Forward power loss = $I_{F(AV)} \times V_{FM}$ at $(I_{F(AV)}/D)$ (see fig. 6);
 Pd_{REV} = Inverse power loss = $V_{R1} \times I_R (1 - D)$; I_R at V_{R1} = Rated V_R

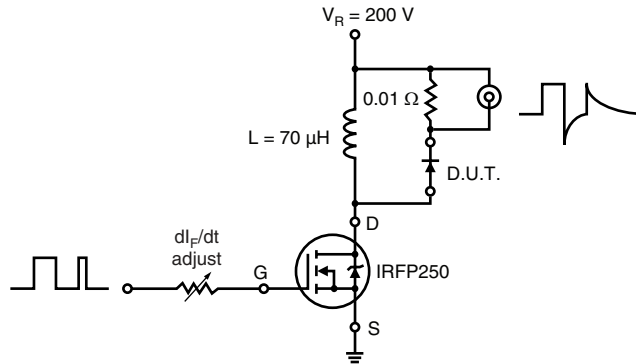
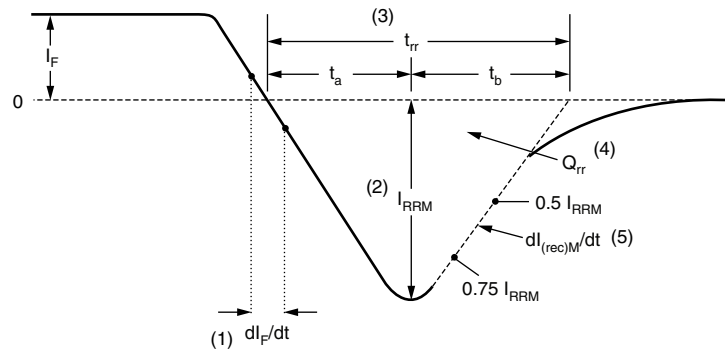

Fig. 9 - Reverse Recovery Parameter Test Circuit



- | | |
|---|---|
| <p>(1) dl_F/dt - rate of change of current through zero crossing</p> <p>(2) I_{RRM} - peak reverse recovery current</p> <p>(3) t_{rr} - reverse recovery time measured from zero crossing point of negative going I_F to point where a line passing through $0.75 I_{RRM}$ and $0.50 I_{RRM}$ extrapolated to zero current.</p> | <p>(4) Q_{rr} - area under curve defined by t_{rr} and I_{RRM}</p> $Q_{rr} = \frac{t_{rr} \times I_{RRM}}{2}$ <p>(5) $dl_{(rec)M}/dt$ - peak rate of change of current during t_b portion of t_{rr}</p> |
|---|---|

Fig. 10 - Reverse Recovery Waveform and Definitions



ORDERING INFORMATION TABLE

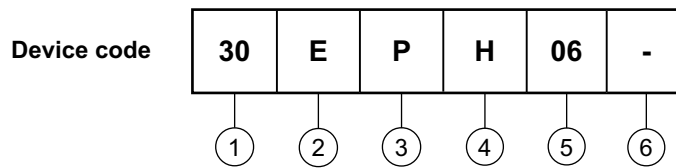

- 1** - Current rating (30 = 30A)
- 2** - Circuit configuration:
E = Single diode
- 3** - Package:
P = TO-247AC modified
- 4** - H = Hyperfast recovery
- 5** - Voltage rating (06 = 600V)
- 6** -
 - None = Standard production
 - PbF = Lead (Pb)-free

Tube standard pack quantity: 25 pieces

LINKS TO RELATED DOCUMENTS	
Dimensions	http://www.vishay.com/doc?95253
Part marking information	http://www.vishay.com/doc?95255



Disclaimer

All product specifications and data are subject to change without notice.

Vishay Intertechnology, Inc., its affiliates, agents, and employees, and all persons acting on its or their behalf (collectively, "Vishay"), disclaim any and all liability for any errors, inaccuracies or incompleteness contained herein or in any other disclosure relating to any product.

Vishay disclaims any and all liability arising out of the use or application of any product described herein or of any information provided herein to the maximum extent permitted by law. The product specifications do not expand or otherwise modify Vishay's terms and conditions of purchase, including but not limited to the warranty expressed therein, which apply to these products.

No license, express or implied, by estoppel or otherwise, to any intellectual property rights is granted by this document or by any conduct of Vishay.

The products shown herein are not designed for use in medical, life-saving, or life-sustaining applications unless otherwise expressly indicated. Customers using or selling Vishay products not expressly indicated for use in such applications do so entirely at their own risk and agree to fully indemnify Vishay for any damages arising or resulting from such use or sale. Please contact authorized Vishay personnel to obtain written terms and conditions regarding products designed for such applications.

Product names and markings noted herein may be trademarks of their respective owners.