

REV.	ECN NO.	DATE	SIGN	DESCRIPTION
C	LEN14B0088	2014/11/03	Vicky	Update Logo & Dimension

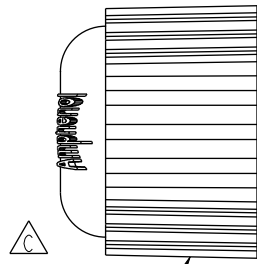

Sealing Nut (5)

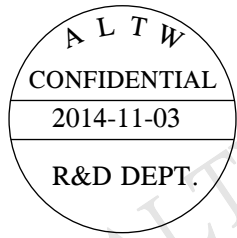
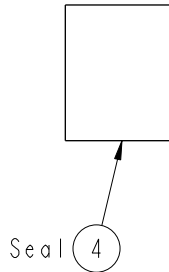

Seal (4)

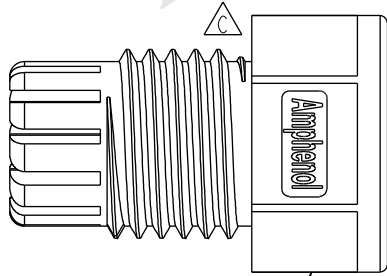

Clamp Ring (3)

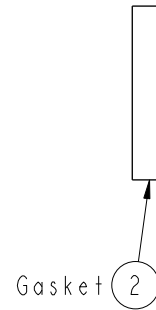

Gasket (2)

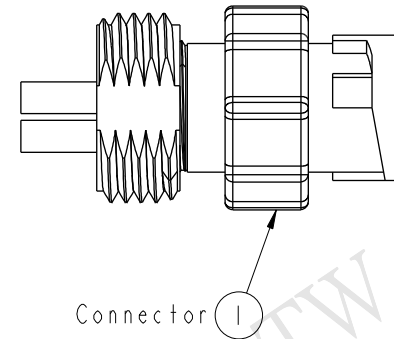

Connector (1)

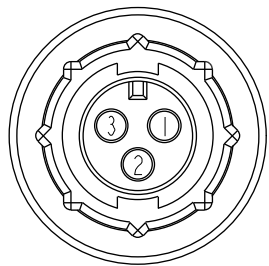

Pin Assignments
Front View

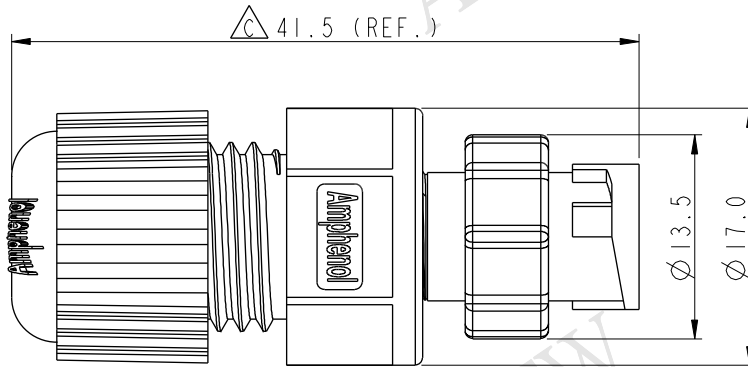

Note:

- * Waterproof Rate: IP67
- * Housing: Nylon+GF, Black
- * Male Pin: Copper Alloy, Gold Plated
- * Gasket: EPDM, Black
- * Clamp Ring: Nylon, Black
- * Seal: EPDM, Black
- * Sealing Nut: Nylon, Black
- * Seal For Cable OD: $\varnothing 4.5\text{mm} \sim \varnothing 6.5\text{mm}$
(防水墊圈線徑: $\varnothing 4.5\text{mm} \sim \varnothing 6.5\text{mm}$)
- * One Set Unassembled In One PE Bag
(每一組未組裝, 放置於一個PE袋, 並封口)

UNIT:mm	
TOLERANCE	
.X	± 0.25
.XX	± 0.1
.XXX	± 0.05
ANGLES	$\pm 1^\circ$

TITLE LOCK TYPE CONN. FOR FIELD INSTALLATION 180° 3PIN M CONN. M PIN (5A)			
SCALE 2:1	SIZE A4	SHEET 1 OF 1	
REV. C	WC-REV. A.2	QC: Inspection item	

Amphenol LTW
安費諾亮泰企業股份有限公司

ITEM NO. AD-03BMMA-LL7001	DRAWN BY Vicky	DATE 2014-11-03
DWG NO. AD-03BMMA-LL7001	CHECKED BY Sam	DATE 2014-11-03
CUSTOMER ALTW	APPROVED BY Rita	DATE 2014-11-03

THIS DOCUMENT IS SUBJECT TO CHANGE WITHOUT NOTICE. IT IS CONFIDENTIAL AND A PROPERTY OF Amphenol LTW. DISCLOSURE TO THIRD PARTY HAS TO BE AUTHORIZED BY Amphenol LTW.