

C3216JB2J223K130AA

TDK Item Description : C3216JB2J223KT****



Application & Main Feature

Commercial Grade (Mid Voltage (100 to 630V))

Series

C3216 [EIA CC1206]

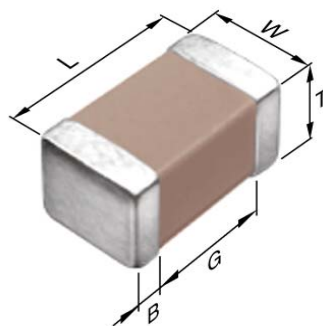

Dimensions

L 3.20mm +/-0.2mm
 W 1.60mm +/-0.2mm
 T 1.30mm +/-0.2mm
 B 0.20mm Min.
 G 1.00mm Min.

Temperature Characteristic

JB (-25 to 85 degC +/-10%)

Rated Voltage

2J (630Vdc)

Capacitance

22nF

Capacitance Tolerance

K (+/-10%)

Dissipation Factor

3% Max.

Insulation Resistance

10Gohm Min.

AEC-Q200

Not Applicable

DC Bias Characteristic

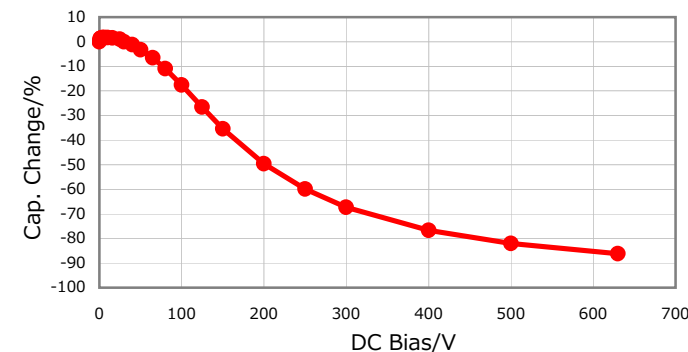

|Z|, ESR vs. Freq. Characteristics

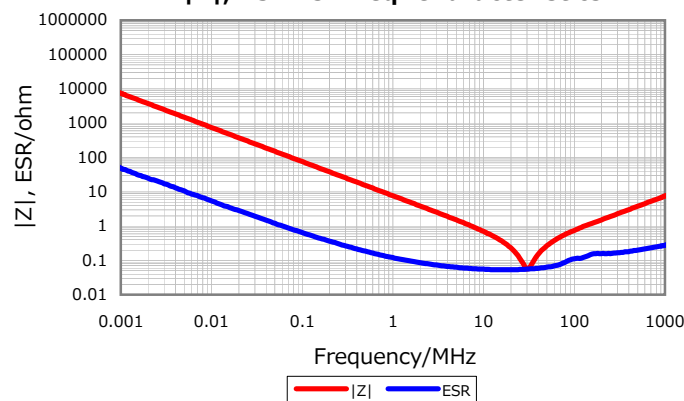

Temperature Characteristics

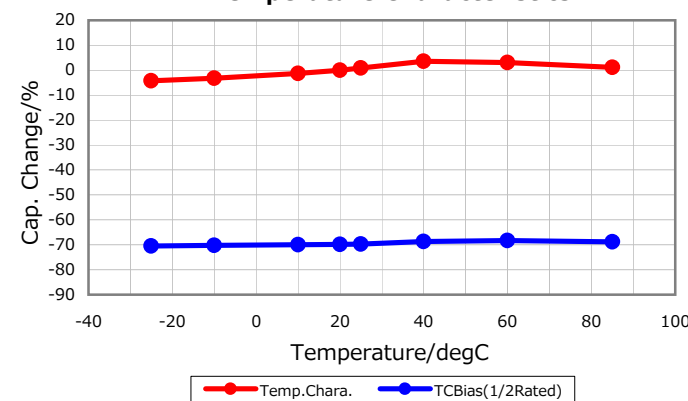

Cap. vs. Freq. Characteristic

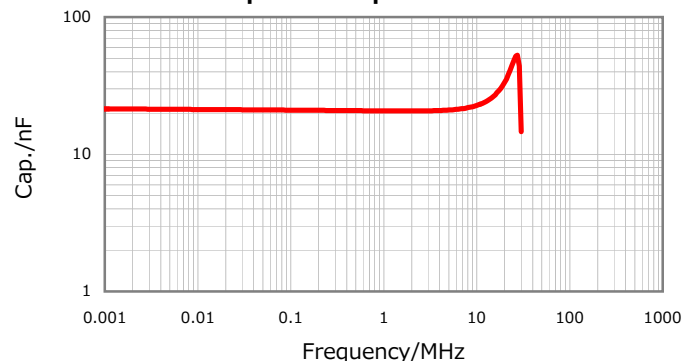

Ripple Temperature Rise Characteristics

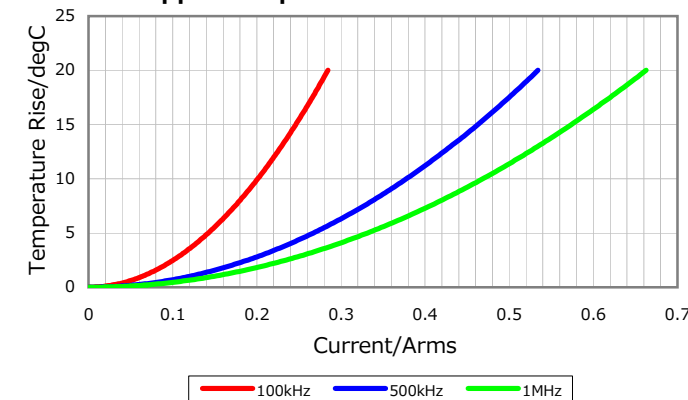

Characterization Sheet (Multilayer Ceramic Chip Capacitors)



⚠ All specifications are subject to change without notice.

January 3, 2016