



**User Manual**

# **SOM-DB5800 A2**

**Development Board for COM  
Express Type 6 Pin-out Modules**

**ADVANTECH**

*Enabling an Intelligent Planet*

---

## Copyright

The documentation and the software included with this product are copyrighted 2012 by Advantech Co., Ltd. All rights are reserved. Advantech Co., Ltd. reserves the right to make improvements in the products described in this manual at any time without notice. No part of this manual may be reproduced, copied, translated or transmitted in any form or by any means without the prior written permission of Advantech Co., Ltd. Information provided in this manual is intended to be accurate and reliable. However, Advantech Co., Ltd. assumes no responsibility for its use, nor for any infringements of the rights of third parties, which may result from its use.

## Acknowledgements

Intel and Pentium are trademarks of Intel Corporation.

Microsoft Windows and MS-DOS are registered trademarks of Microsoft Corp.

All other product names or trademarks are properties of their respective owners.

## Product Warranty (2 years)

Advantech warrants to you, the original purchaser, that each of its products will be free from defects in materials and workmanship for two years from the date of purchase.

This warranty does not apply to any products which have been repaired or altered by persons other than repair personnel authorized by Advantech, or which have been subject to misuse, abuse, accident or improper installation. Advantech assumes no liability under the terms of this warranty as a consequence of such events.

Because of Advantech's high quality-control standards and rigorous testing, most of our customers never need to use our repair service. If an Advantech product is defective, it will be repaired or replaced at no charge during the warranty period. For out-of-warranty repairs, you will be billed according to the cost of replacement materials, service time and freight. Please consult your dealer for more details.

If you think you have a defective product, follow these steps:

1. Collect all the information about the problem encountered. (For example, CPU speed, Advantech products used, other hardware and software used, etc.) Note anything abnormal and list any onscreen messages you get when the problem occurs.
2. Call your dealer and describe the problem. Please have your manual, product, and any helpful information readily available.
3. If your product is diagnosed as defective, obtain an RMA (return merchandise authorization) number from your dealer. This allows us to process your return more quickly.
4. Carefully pack the defective product, a fully-completed Repair and Replacement Order Card and a photocopy proof of purchase date (such as your sales receipt) in a shippable container. A product returned without proof of the purchase date is not eligible for warranty service.
5. Write the RMA number visibly on the outside of the package and ship it prepaid to your dealer.

Part No. 2006580001

Printed in Taiwan

Edition 2

July 2012

# Declaration of Conformity

## CE

This product has passed the CE test for environmental specifications. Test conditions for passing included the equipment being operated within an industrial enclosure. In order to protect the product from being damaged by ESD (Electrostatic Discharge) and EMI leakage, we strongly recommend the use of CE-compliant industrial enclosure products.

## FCC Class B

Note: This equipment has been tested and found to comply with the limits for a Class B digital device, pursuant to part 15 of the FCC Rules. These limits are designed to provide reasonable protection against harmful interference in a residential installation. This equipment generates, uses and can radiate radio frequency energy and, if not installed and used in accordance with the instructions, may cause harmful interference to radio communications. However, there is no guarantee that interference will not occur in a particular installation. If this equipment does cause harmful interference to radio or television reception, which can be determined by turning the equipment off and on, the user is encouraged to try to correct the interference by one or more of the following measures:

Reorient or relocate the receiving antenna.

Increase the separation between the equipment and receiver.

Connect the equipment into an outlet on a circuit different from that to which the receiver is connected.

Consult the dealer or an experienced radio/TV technician for help.

# Technical Support and Assistance

1. Visit the Advantech website at <http://support.advantech.com> where you can find the latest information about the product.
2. Contact your distributor, sales representative, or Advantech's customer service center for technical support if you need additional assistance. Please have the following information ready before you call:
  - Product name and serial number
  - Description of your peripheral attachments
  - Description of your software (operating system, version, application software, etc.)
  - A complete description of the problem
  - The exact wording of any error messages

---

## Warnings, Cautions and Notes

**Warning!** Warnings indicate conditions, which if not observed, can cause personal injury!



**Caution!** Cautions are included to help you avoid damaging hardware or losing data. e.g.



*There is a danger of a new battery exploding if it is incorrectly installed. Do not attempt to recharge, force open, or heat the battery. Replace the battery only with the same or equivalent type recommended by the manufacturer. Discard used batteries according to the manufacturer's instructions.*

**Note!** Notes provide optional additional information.



## Document Feedback

To assist us in making improvements to this manual, we would welcome comments and constructive criticism. Please send all such - in writing to:

support@advantech.com

## Packing List

Before setting up the system, check that the items listed below are included and in good condition. If any item does not accord with the table, please contact your dealer immediately.

### **SOM-DB5800-U0A2E:**

- 1 DB5800 A2 development board
- 1 SOM-EA20 HDMI/DisplayPort Riser Card
- 1 PCIe x4 to 4 PCIe x1 Riser Card
- 1 SOM-EA00 Type 10 - to - Type 6 Transition Board
- 2 Serial ATA cable 7P/ 7P 30cm
- 2 Flat COM port cable
- 1 I/O Shield Bracket
- 1 DDI card Bracket for SOM-EA20
- 5 Standoff (screw)
- 5 NUT (screw)
- 2 M3.5L screw
- 3 M2.5L screw

### **SOM-DB5800-00A2E :**

- 1 DB5800 A2 development board
- 1 SOM-EA20 HDMI/DisplayPort Riser Card
- 1 PCIe x4 to 4 PCIe x1 Riser Card
- 2 Serial ATA cable 7P/ 7P 30cm
- 2 Flat COM port cable

- 1 I/O Shield Bracket
- 1 DDI card Bracket for SOM-EA20
- 5 Standoff (screw)
- 5 NUT (screw)
- 2 M3.5L screw
- 3 M2.5L screw

## Safety Instructions

1. Read these safety instructions carefully.
2. Keep this User Manual for later reference.
3. Disconnect this equipment from any AC outlet before cleaning. Use a damp cloth. Do not use liquid or spray detergents for cleaning.
4. For plug-in equipment, the power outlet socket must be located near the equipment and must be easily accessible.
5. Keep this equipment away from humidity.
6. Put this equipment on a reliable surface during installation. Dropping it or letting it fall may cause damage.
7. The openings on the enclosure are for air convection. Protect the equipment from overheating. **DO NOT COVER THE OPENINGS.**
8. Make sure the voltage of the power source is correct before connecting the equipment to the power outlet.
9. Position the power cord so that people cannot step on it. Do not place anything over the power cord.
10. All cautions and warnings on the equipment should be noted.
11. If the equipment is not used for a long time, disconnect it from the power source to avoid damage by transient overvoltage.
12. Never pour any liquid into an opening. This may cause fire or electrical shock.
13. Never open the equipment. For safety reasons, the equipment should be opened only by qualified service personnel.
14. If one of the following situations arises, get the equipment checked by service personnel:
  - The power cord or plug is damaged.
  - Liquid has penetrated into the equipment.
  - The equipment has been exposed to moisture.
  - The equipment does not work well, or you cannot get it to work according to the user's manual.
  - The equipment has been dropped and damaged.
  - The equipment has obvious signs of breakage.
15. **DO NOT LEAVE THIS EQUIPMENT IN AN ENVIRONMENT WHERE THE STORAGE TEMPERATURE MAY GO BELOW -20° C (-4° F) OR ABOVE 60° C (140° F). THIS COULD DAMAGE THE EQUIPMENT. THE EQUIPMENT SHOULD BE IN A CONTROLLED ENVIRONMENT.**
16. **CAUTION: DANGER OF EXPLOSION IF BATTERY IS INCORRECTLY REPLACED. REPLACE ONLY WITH THE SAME OR EQUIVALENT TYPE RECOMMENDED BY THE MANUFACTURER, DISCARD USED BATTERIES ACCORDING TO THE MANUFACTURER'S INSTRUCTIONS.**

The sound pressure level at the operator's position according to IEC 704-1:1982 is no more than 70 dB (A).

**DISCLAIMER:** This set of instructions is given according to IEC 704-1. Advantech disclaims all responsibility for the accuracy of any statements contained herein.

---

## Safety Precaution - Static Electricity

Follow these simple precautions to protect yourself from harm and the products from damage.

- To avoid electrical shock, always disconnect the power from your PC chassis before you work on it. Don't touch any components on the CPU card or other cards while the PC is on.
- Disconnect power before making any configuration changes. The sudden rush of power as you connect a jumper or install a card may damage sensitive electronic components.

# Contents

<b>Chapter 1</b>	<b>General Information .....</b>	<b>1</b>
1.1	Introduction .....	2
1.2	SOM-DB5800 A2 Connectors and Jumper Setting .....	2
1.2.1	SOM-DB5800 A2 Connector Location .....	2
	Figure 1.1 SOM-DB5800 A2 Connector Location .....	2
1.2.2	IO Connector Location .....	3
1.2.3	Button Location .....	3
1.2.4	Jumper and Switch Location .....	4
	Figure 1.2 SOM-DB5800 A2 Default Jumper Setting .....	4
1.2.5	Connector List .....	5
	Table 1.1: Connector List .....	5
1.2.6	Jumper, Switch and Button List .....	6
	Table 1.2: Jumper, Switch and Button List .....	6
1.2.7	Connector Pin Definition .....	7
	Table 1.3: DDI1 Digital Display Interface Connector .....	7
	Table 1.4: GPIO1: GPIO Pin Header .....	11
	Table 1.5: LPC_PH1: Low Pin Count Pin Header .....	11
	Table 1.6: LVDS1: LVDS Interface Connector .....	12
	Table 1.7: LVDS_INVERTER1: LVDS Inverter Wafer Box .....	13
	Table 1.8: DCIN1: Wide Range DC Input Connector .....	13
	Table 1.9: SYS_FAN1: System Fan Connector .....	13
	Table 1.10: SMART_FAN1: Smart Fan Connector .....	14
	Table 1.11: I2C1: I2C Wafer Box .....	14
	Table 1.12: SMB1: SMBus Wafer Box .....	14
	Table 1.13: COM2: COM Port Connector (RS232/422/485) .....	15
	Table 1.14: COM3: UART Connector (Tx, Rx) .....	15
	Table 1.15: COM4: UART Connector (Tx, Rx) .....	15
	Table 1.16: SIR1: Serial IrDA Wafer Box .....	16
1.2.8	Jumper Setting .....	16
	Table 1.17: J1: GPIO / SDIO Selection .....	16
	Table 1.18: J2, J3: BIOS Disable0, BIOS Disable1 .....	16
	Table 1.19: J4: LVDS GND / eDP Hot Plug Selection .....	16
	Table 1.20: J5: LVDS Inverter Voltage Selection .....	17
	Table 1.21: J6, J7: LVDS Panel Voltage Selection .....	17
	Table 1.22: J8, J9: SOM-D5800 Voltage Input (VIN) Selection .....	17
	Table 1.23: J10: COMe Module TPM Disable .....	17
	Table 1.24: J11: COMe Module +V5SB Supply .....	17
	Table 1.25: J12: PEG Lanes Reverse .....	18
	Table 1.26: J13: PEG Function Enable .....	18
	Table 1.27: J14: ATX / AT Mode Selection .....	18
	Table 1.28: J15: COMe Module Type6 Detection .....	18
	Table 1.29: J16: Front Panel Connector .....	19
	Table 1.30: J17: USB7 Client / Host Selection .....	19
	Table 1.31: J18: Normal Operation / Clear COMS Selection .....	19
	Table 1.32: J19: COM2 RS232 / RS422 / RS485 Selection .....	19
	Table 1.33: DDI_DDC_1: Digital Display Interface - AUX / DDC Switch .....	20
	Table 1.34: SW_LPC_SIO1 & SW_LPC_SIO2: SIO Enable/Dis- able Switch .....	20
	Table 1.35: SW_LPC_TPM1 & SW_LPC_TPM2: TPM Enable/Dis- able Switch .....	20
1.3	SOM-EA20 .....	21
1.3.1	Connector and Jumper Location .....	21
	Table 1.36: Connector, Jumper, Switch List .....	21

1.3.2	SOM-EA20 Block Diagram .....	22
1.3.3	Golden Finger Pin Definition.....	22
	Table 1.37: DDI1 Digital Display Interface Pin Definition .....	22
1.3.4	Switch Setting .....	26
	Table 1.38: SW1 ~ SW5: DDI1 DisplayPort B / HDMI Port B Switch 26	
	Table 1.39: SW7 ~ SW12: DDI2 DisplayPort C / HDMI Port C Switch.....	26
	Table 1.40: SW13 ~ SW17: DDI3 DisplayPort D / HDMI Port D Switch.....	27
	Table 1.41: SW1 ~ SW5: DDI1 DisplayPort B / HDMI Port B Switch 27	
	Table 1.42: SW7 ~ SW12: DDI2 DisplayPort C / HDMI Port C Switch.....	27
	Table 1.43: SW13 ~ SW17: DDI3 DisplayPort D / HDMI Port D Switch.....	28
1.3.5	Jumper Setting.....	28
	Table 1.44: DDI1_HPDP1: DDI1 DisplayPort B / HDMI Port B Hot Plug Selection .....	28
	Table 1.45: DDI2_HPDP1: DDI2 DisplayPort C / HDMI Port C Hot Plug Selection .....	28
	Table 1.46: DDI3_HPDP1: DDI3 DisplayPort D / HDMI Port D Hot Plug Selection .....	28
1.4	SOM-EA10.....	29
1.4.1	Connector Location.....	29
1.4.2	Connector List.....	29
	Table 1.47: Connector List .....	29
1.4.3	SOM-EA10 Block Diagram .....	29
1.5	SOM-EA00.....	30
1.5.1	Connector Location.....	30
	Table 1.48: Connector List .....	30
1.5.2	SOM-EA00 Block Diagram .....	30



# Chapter 1

General Information

## 1.1 Introduction

SOM-DB5800 A2 is a development board for COM-Express Type 6/10 pin-out module that fully complies with the PCI Industrial Computer Manufacturers PICMG COM Express standard. It is suitable for different form factor modules including COM-Basic, COM-Compact, and COM-Mini. All functions provided by COM-Express type 6 pin-outs are implemented on SOM-DB5800 A2 with the most popular interfaces or connectors for ease of development and verification. Additional accessories help customers evaluate more applications, such as DDI cards that provide extended functions for HDMI/Displayport, PCIe riser card extend PCIe x4 to PCIe x1, and transition boards make SOM-DB5800 A2 compatible with type 10 pin-out. This board provides a reliable testing platform and the flexibility for customer vertical market application pre-study.

## 1.2 SOM-DB5800 A2 Connectors and Jumper Setting

### 1.2.1 SOM-DB5800 A2 Connector Location

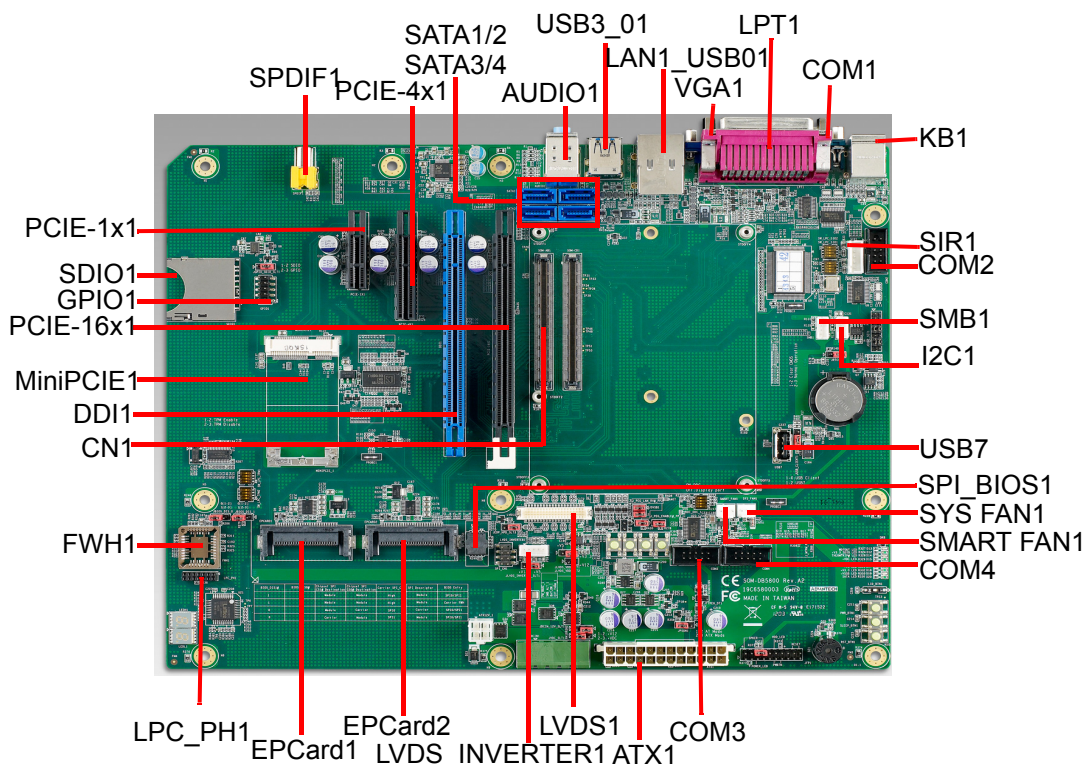
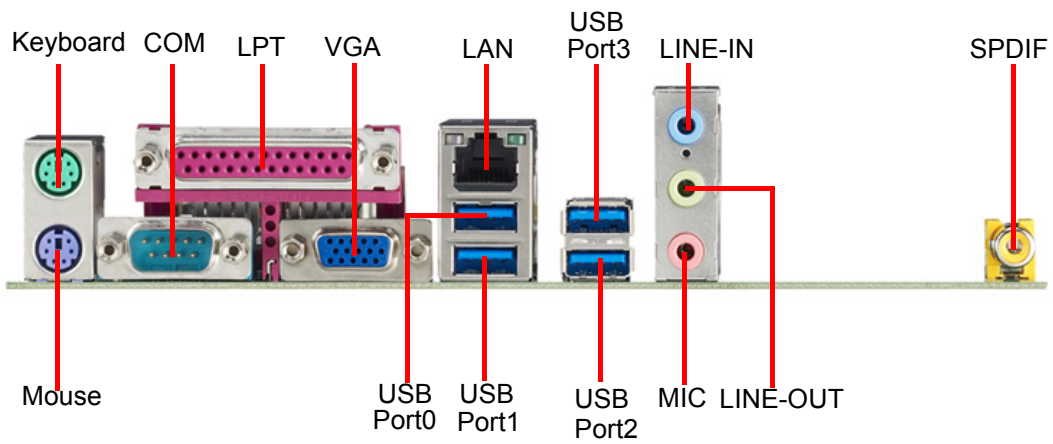
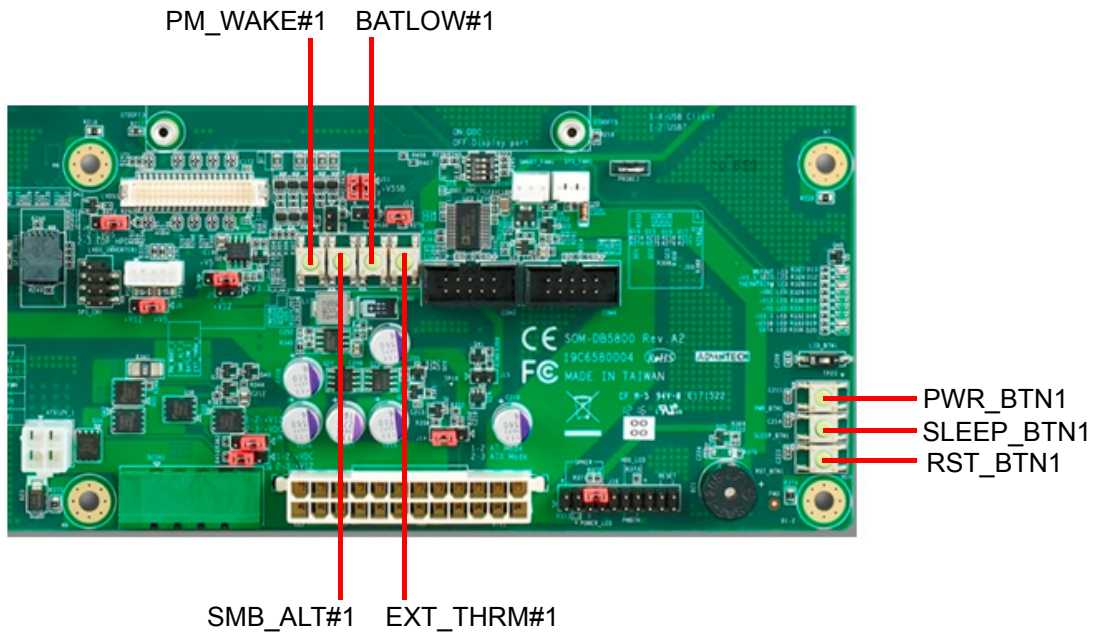


Figure 1.1 SOM-DB5800 A2 Connector Location

### 1.2.2 IO Connector Location



### 1.2.3 Button Location



## 1.2.4 Jumper and Switch Location

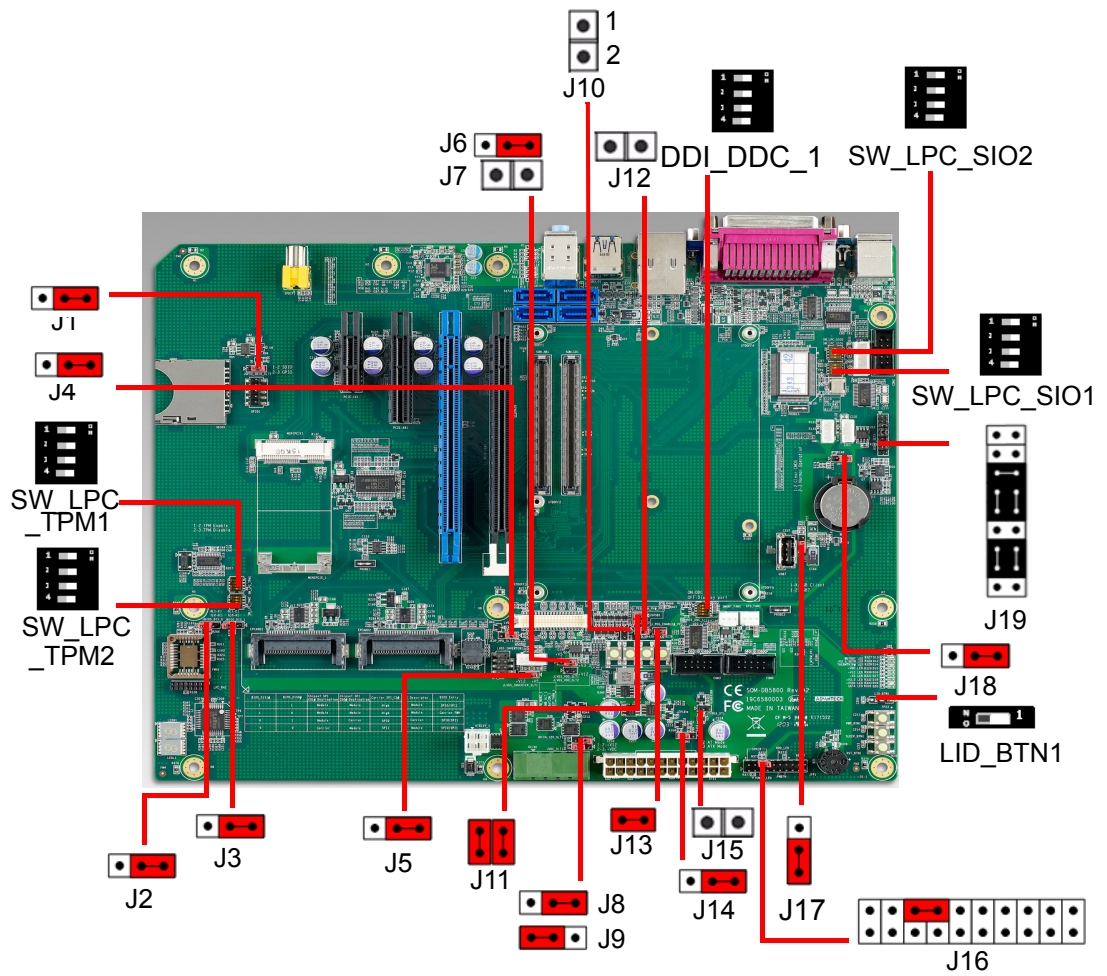


Figure 1.2 SOM-DB5800 A2 Default Jumper Setting

## 1.2.5 Connector List

Table 1.1: Connector List	
Label	Function
ATX1	ATX Connector
AUDIO1	Line-in, Line-out and MIC Connector
CN1	COM Express Connector
COM1	COM Port Connector (RS232)
COM2	COM Port Connector (RS232/422/485)
COM3	UART Connector (Tx, Rx)
COM4	UART Connector (Tx, Rx)
DCIN1	Wide Range DC Input Connector
DDI1	Digital Display Interface Connector
EPCard1	Express Card Connector 1 (include USB2.0 Port4)
EPCard2	Express Card Connector 2 (include USB2.0 Port5)
FWH1	Firmware Hub Socket
GPIO1	GPIO Pin Header
I2C1	I2C Wafer Box
KB1	PS/2 Keyboard and Mouse Connector
LAN1_USB_01	LAN1, USB3.0/2.0 Port0 and Port1 Connector
LPC_PH1	Low Pin Count Pin Header
LPT1	Printer Port Connector
LVDS_INVERTER1	LVDS Inverter Power Wafer Box
LVDS1	LVDS Interface Connector
MiniPCIE1	Mini-PCle Connector (include USB2.0 Port6)
PCIE-16X1	PCle x16 slot
PCIE-4X1	PCle x4 slot
PCIE-1X1	PCle x1 slot
SATA1	SATA Connector
SATA2	SATA Connector
SATA3	SATA Connector
SATA4	SATA Connector
SDIO1	SDIO Connector
SIR1	Serial IrDA Wafer Box
SMART_FAN1	Smart Fan Connector
SMB1	SMBus Wafer Box
SPDIF1	SPDIF Connector
SPI_BIOS1	SPI BIOS Socket
SYS_FAN1	System Fan Connector
USB3_01	USB3.0/2.0 Port2 and Port3 Connector
USB7	USB2.0 Port7 Connector
VGA1	CRT Connector

## 1.2.6 Jumper, Switch and Button List

**Table 1.2: Jumper, Switch and Button List**

<b>Label</b>	<b>Function</b>
J1	GPIO / SDIO Selection
J2	BIOS Disable0
J3	BIOS Disable1
J4	LVDS GND / eDP Hot Plug Selection
J5	LVDS Inverter Voltage Selection
J6, J7	LVDS Panel Voltage Selection
J8, J9	SOM-D5800 Voltage Input (VIN) Selection
J10	COMe Module TPM Disable
J11	COMe Module +V5SB supply
J12	PEG Lanes Reverse
J13	PEG Function Enable
J14	ATX / AT Mode Selection
J15	COMe Module Type6 Detection
J16	Front Panel Connector
J17	USB7 Client / Host Selection
J18	Normal Operation / Clear COMS Selection
J19	COM2 RS232 / RS422 / RS485 Selection
DDI_DDC_1	Digital Display Interface - AUX / DDC Switch
SW_LPC_SIO1	SIO Enable/Disable Switch
SW_LPC_SIO2	SIO Enable/Disable Switch
SW_LPC_TPM1	TPM Enable/Disable Switch
SW_LPC_TPM2	TPM Enable/Disable Switch
PWR_BTN1	Power Button
RST_BTN1	Reset Button
SLEEP_BTN1	Sleep Button
PM_WAKE#1	Wake Button
LID_BTN1	LID Button
SMB_ALT#1	SM Bus Alert Button
BATLOW#1	Battery Low Button
EXT_THRM#1	External Thermal Trip Button

## 1.2.7 Connector Pin Definition

**Table 1.3: DDI1 Digital Display Interface Connector**

Pin	Signal
A1	NC
A2	+V12
A3	+V12
A4	GND
A5	NC
A6	NC
A7	NC
A8	NC
A9	+V3.3
A10	+V3.3
A11	PLTRST#
A12	GND
A13	NC
A14	NC
A15	GND
A16	DDI1_PAIR5+
A17	DDI1_PAIR5-
A18	GND
A19	NC
A20	GND
A21	DDI1_PAIR4+
A22	DDI1_PAIR4-
A23	GND
A24	GND
A25	DDI1_PAIR6+
A26	DDI1_PAIR6-
A27	GND
A28	GND
A29	DDI1_HPD
A30	NC
A31	GND
A32	NC
A33	NC
A34	GND
A35	DDI1_CTRLCLK_AUX+
A36	DDI1_CTRLDATA_AUX-
A37	GND
A38	GND
A39	NC
A40	NC
A41	GND
A42	GND
A43	DDI2_CTRLCLK_AUX+

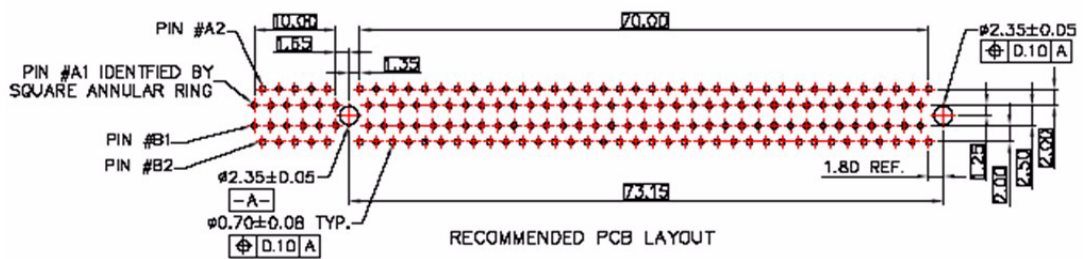
**Table 1.3: DDI1 Digital Display Interface Connector**

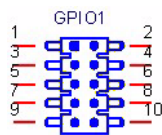
A44	DDI2_CTRLDATA_AUX-
A45	GND
A46	GND
A47	DDI2_HPD
A48	NC
A49	GND
A50	NC
A51	GND
A52	NC
A53	NC
A54	GND
A55	GND
A56	NC
A57	NC
A58	GND
A59	GND
A60	DDI3_CTRLCLK_AUX+
A61	DDI3_CTRLDATA_AUX-
A62	GND
A63	GND
A64	DDI3_HPD
A65	NC
A66	GND
A67	GND
A68	NC
A69	NC
A70	GND
A71	GND
A72	NC
A73	NC
A74	GND
A75	GND
A76	NC
A77	NC
A78	GND
A79	GND
A80	NC
A81	NC
A82	GND



Pin	Signal
B1	+V12
B2	+V12
B3	+V12
B4	GND
B5	NC
B6	NC
B7	GND
B8	+V3.3
B9	NC
B10	+V3.3_DUAL
B11	NC
B12	NC
B13	GND
B14	DDI1_PAIR0+
B15	DDI1_PAIR0-
B16	GND
B17	DDI1_CTRLCLK_AUX+
B18	GND
B19	DDI1_PAIR1+
B20	DDI1_PAIR1-
B21	GND
B22	GND
B23	DDI1_PAIR2+
B24	DDI1_PAIR2-
B25	GND
B26	GND
B27	DDI1_PAIR3+
B28	DDI1_PAIR3-
B29	GND
B30	NC
B31	DDI1_CTRLDATA_AUX-
B32	GND
B33	DDI2_PAIR0+
B34	DDI2_PAIR0-
B35	GND
B36	GND
B37	DDI2_PAIR1+
B38	DDI2_PAIR1-
B39	GND
B40	GND
B41	DDI2_PAIR2+
B42	DDI2_PAIR2-
B43	GND
B44	GND
B45	DDI2_PAIR3+
B46	DDI2_PAIR3-

B47	GND
B48	NC
B49	GND
B50	DDI3_PAIR0+
B51	DDI3_PAIR0-
B52	GND
B53	GND
B54	DDI3_PAIR1+
B55	DDI3_PAIR1-
B56	GND
B57	GND
B58	DDI3_PAIR2+
B59	DDI3_PAIR2-
B60	GND
B61	GND
B62	DDI3_PAIR3+
B63	DDI3_PAIR3-
B64	GND
B65	GND
B66	NC
B67	NC
B68	GND
B69	GND
B70	NC
B71	NC
B72	GND
B73	GND
B74	NC
B75	NC
B76	GND
B77	GND
B78	NC
B79	NC
B80	GND
B81	NC
B82	NC

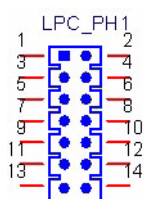




PH\_5x2V\_S2.54mm

**Table 1.4: GPIO1: GPIO Pin Header**

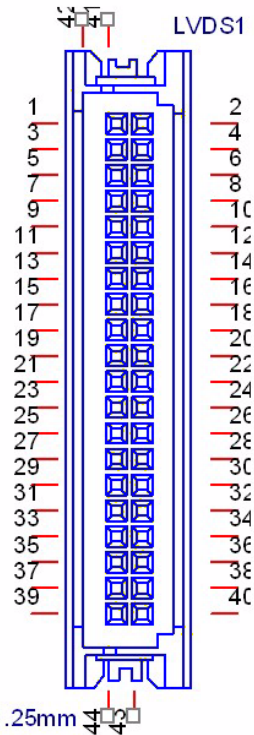
Pin	Signal	Pin	Signal
1	GPI0	6	GPO2
2	GPO0	7	GPI3
3	GPI1	8	GPO3
4	GPO1	9	GND
5	GPI2	10	GND



PH(F)\_7x2V\_2.00mm

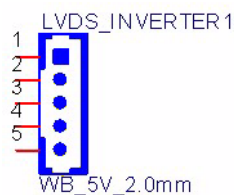
**Table 1.5: LPC\_PH1: Low Pin Count Pin Header**

Pin	Signal	Pin	Signal
1	CLK33M_PH	8	GND
2	LPC_AD1	9	LPC_AD2
3	PLTRST#	10	Pull-up via 10K ohm to +V3.3
4	LPC_AD0	11	SERIRQ
5	LPC_FRAME#	12	PLTRST#
6	+V3.3	13	+V5_DUAL
7	LPC_AD3	14	+V5



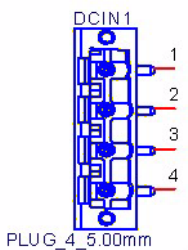
**Table 1.6: LVDS1: LVDS Interface Connector**

Pin	Signal	Pin	Signal
1	+V3.3_LVDS_PANEL	21	LVDS0_Z_D2+
2	+V3.3_LVDS_PANEL	22	LVDS1_Z_D2+
3	GND	23	GND
4	GND	24	GND
5	+V3.3_LVDS_PANEL	25	LVDS0_Z_CLK-
6	+V3.3_LVDS_PANEL	26	LVDS1_Z_CLK-
7	LVDS0_Z_D0-	27	LVDS0_Z_CLK+
8	LVDS1_Z_D0-	28	LVDS1_Z_CLK+
9	LVDS0_Z_D0+	29	GND
10	LVDS1_Z_D0+	30	GND
11	GND	31	LVDS_DDC_SC
12	GND	32	LVDS_DDC_SD
13	LVDS0_Z_D1-	33	GND
14	LVDS1_Z_D1-	34	GND
15	LVDS0_Z_D1+	35	LVDS0_Z_D3
16	LVDS1_Z_D1+	36	LVDS1_Z_D3-
17	GND	37	LVDS0_Z_D3+
18	GND	38	LVDS1_Z_D3+
19	LVDS0_Z_D2-	39	Pull-down via 4.7K ohm to GND
20	LVDS1_Z_D2-	40	LVDS_CTRL



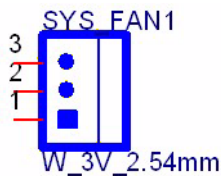
**Table 1.7: LVDS\_INVERTER1: LVDS Inverter Wafer Box**

Pin	Signal
1	+V12_Z_LVDS
2	GND
3	LVDS_BKLT_Z_EN#
4	LVDS_Z_VBR
5	+V5_LVDS



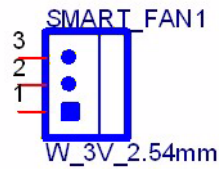
**Table 1.8: DCIN1: Wide Range DC Input Connector**

Pin	Signal
1	GND
2	+VDC
3	+VDC
4	GND



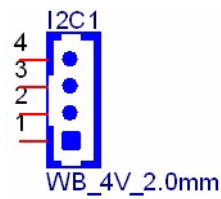
**Table 1.9: SYS\_FAN1: System Fan Connector**

Pin	Signal
1	GND
2	+V12
3	SYSFAN_IN



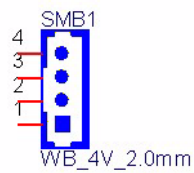
**Table 1.10: SMART\_FAN1: Smart Fan Connector**

Pin	Signal
1	GND
2	+V_FAN
3	FANTACH_R1



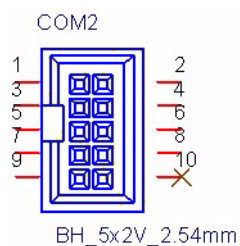
**Table 1.11: I<sup>2</sup>C1: I<sup>2</sup>C Wafer Box**

Pin	Signal
1	GND
2	I2C_DAT
3	I2C_CLK
4	+V3.3_DUAL



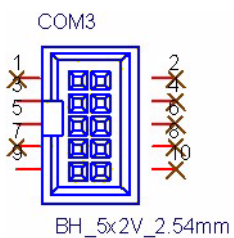
**Table 1.12: SMB1: SMBus Wafer Box**

Pin	Signal
1	GND
2	SMB_DAT
3	SMB_CLK
4	+V3.3_DUAL



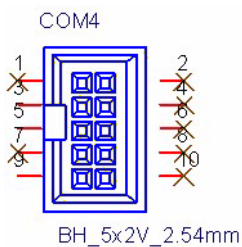
**Table 1.13: COM2: COM Port Connector (RS232/422/485)**

Pin	Signal	Pin	Signal
1	NDCD#2_TXD485-	6	COM2_CTS#
2	COM2_DSR#	7	NDTR#2_RXD485-
3	NRXD2_TXD485+	8	COM2_RI#
4	COM2_RTS#	9	GND
5	NTXD2_RXD485+	10	NC



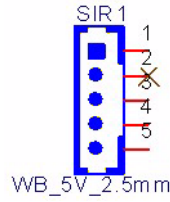
**Table 1.14: COM3: UART Connector (Tx, Rx)**

Pin	Signal	Pin	Signal
1	NC	6	NC
2	NC	7	NC
3	RS1_RX	8	NC
4	NC	9	GND
5	RS1_TX	10	NC



**Table 1.15: COM4: UART Connector (Tx, Rx)**

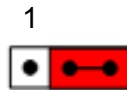
Pin	Signal	Pin	Signal
1	NC	6	NC
2	NC	7	NC
3	RS2_RX	8	NC
4	NC	9	GND
5	RS2_TX	10	NC



**Table 1.16: SIR1: Serial IrDA Wafer Box**

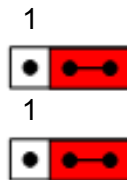
Pin	Signal
1	+V5
2	NC
3	IRRX
4	GND
5	IRTX

## 1.2.8 Jumper Setting



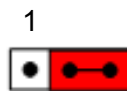
**Table 1.17: J1: GPIO / SDIO Selection**

Pin	Function
1-2	SDIO
2-3	GPIO [Default]



**Table 1.18: J2, J3: BIOS Disable0, BIOS Disable1**

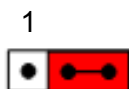
BIOS_DIS 1#(J3)	BIOS_DIS 0#(J2)	Chipset SPI CS1# Destination	Chipset SPI CS0# Destination	Carrier SPI_CS#	SPI Descriptor	BIOS Entry
2-3 (1)	2-3 (1)	Module	Module	High	Module	SPI0/SPI1 [Default]
2-3 (1)	1-2 (0)	Module	Module	High	Module	Carrier FWH
1-2 (0)	2-3 (1)	Module	Carrier	SPI0	Carrier	SPI0/SPI1
1-2 (0)	1-2 (0)	Carrier	Module	SPI1	Module	SPI0/SPI1



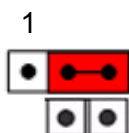
**Table 1.19: J4: LVDS GND / eDP Hot Plug Selection**

Pin	Function
1-2	LVDS GND [Default]
2-3	eDP Hot Plug




**Table 1.20: J5: LVDS Inverter Voltage Selection**

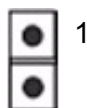
Pin	Function
1-2	+V5 [Default]
2-3	+V12


**Table 1.21: J6, J7: LVDS Panel Voltage Selection**

Pin	Function
J6 1-2	+V5
J6 2-3	+V3.3 [Default]
J6 & J7 2-2	+V12


**Table 1.22: J8, J9: SOM-D5800 Voltage Input (VIN) Selection**

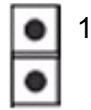
Pin	Function
J8 1-2 J9 2-3	Supply ATX (+V12) to VIN [Default]
J8 2-3 J9 1-2	Supply DCIN (+VDC) to VIN


**Table 1.23: J10: COMe Module TPM Disable**

Pin	Function
1-X	COMe Module TPM Enable [Default]
1-2	COMe Module TPM Disable

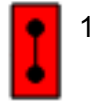

**Table 1.24: J11: COMe Module +V5SB Supply**

Pin	Function
1-X 3-X	Not supply +V5SB to COMe Module
1-2 3-4	Supply +V5SB to COMe Module [Default]



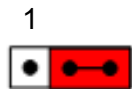
**Table 1.25: J12: PEG Lanes Reverse**

Pin	Function
1-X	Disable [Default]
1-2	Enable



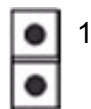
**Table 1.26: J13: PEG Function Enable**

Pin	Function
1-x	PEG Function Disable
1-2	PEG Function Enable [Default]



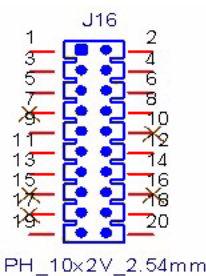
**Table 1.27: J14: ATX / AT Mode Selection**

Pin	Function
1-2	AT Mode
2-3	ATX Mode [Default]



**Table 1.28: J15: COMe Module Type6 Detection**

Pin	Function
1-X	Type6 Detection Enable [Default]
1-2	Type6 Detection Disable



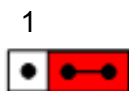
**Table 1.29: J16: Front Panel Connector**

Pin	Function
3-5	Power LED (Pin1 is positive)
6-8	Buzzer Enable
12-14	HDD LED (Pin14 is positive)
11-13	Power Button
18-20	Reset Button



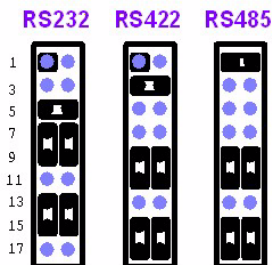
**Table 1.30: J17: USB7 Client / Host Selection**

Pin	Function
1-2	USB7 Host [Default]
2-3	USB7 Client



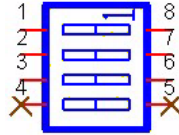
**Table 1.31: J18: Normal Operation / Clear COMS Selection**

Pin	Function
1-2	Clear CMOS
2-3	Normal Operation [Default]



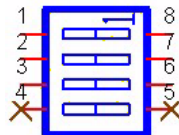
**Table 1.32: J19: COM2 RS232 / RS422 / RS485 Selection**

Pin	Function
5-6, 7-9, 8-10 , 13-15, 14-16	RS232
3-4, 9-11, 10-12, 15-17, 16-18	RS422
1-2, 9-11, 10-12, 15-17, 16-18	RS485



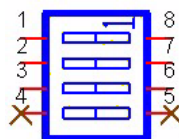
**Table 1.33: DDI\_DDC\_1: Digital Display Interface - AUX / DDC Switch**

Dip Switch	1-8	2-7	3-6	4-5	Function
DDI_DDC_1	ON	-	-	-	CN1 pin D15 & D16 configured as DDI1 DDC for HDMI [Default]
	OFF	-	-	-	CN1 pin D15 & D16 configured as DDI1 AUX for DisplayPort
	-	ON	-	-	CN1 pin C32 & C33 configured as DDI2 DDC for HDMI [Default]
	-	OFF	-	-	CN1 pin C32 & C33 configured as DDI2 AUX for DisplayPort
	-	-	ON	-	CN1 pin C36 & C37 configured as DDI3 DDC for HDMI [Default]
	-	-	OFF	-	CN1 pin C36 & C37 configured as DDI3 AUX for DisplayPort



**Table 1.34: SW\_LPC\_SIO1 & SW\_LPC\_SIO2: SIO Enable/Disable Switch**

Dip Switch	1-8	2-7	3-6	4-5	Function
SW_LPC_SIO1 ~ SW_LPC_SIO2	ON	ON	ON	ON	SIO Enable [Default]
	OFF	OFF	OFF	OFF	SIO Disable

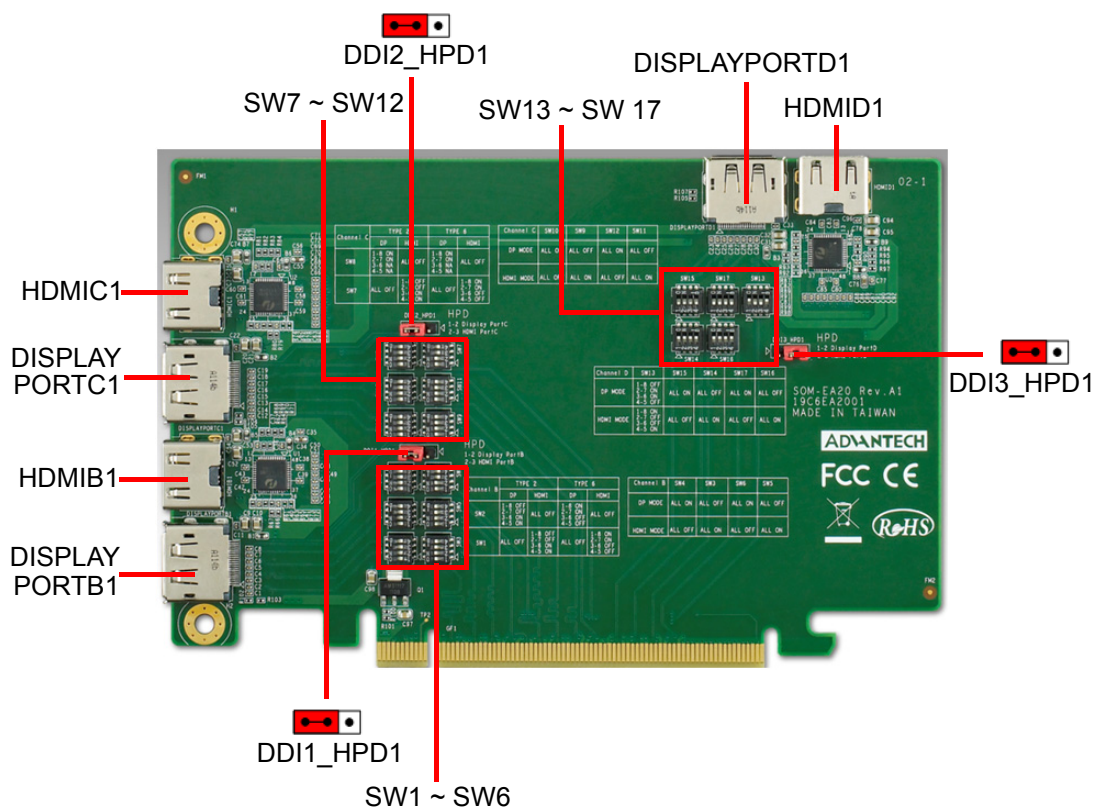


**Table 1.35: SW\_LPC\_TPM1 & SW\_LPC\_TPM2: TPM Enable/Disable Switch**

Dip Switch	1-8	2-7	3-6	4-5	Function
SW_LPC_TPM1 ~ SW_LPC_TPM2	ON	ON	ON	ON	TPM Enable [Default]
	OFF	OFF	OFF	OFF	TPM Disable

## 1.3 SOM-EA20

### 1.3.1 Connector and Jumper Location



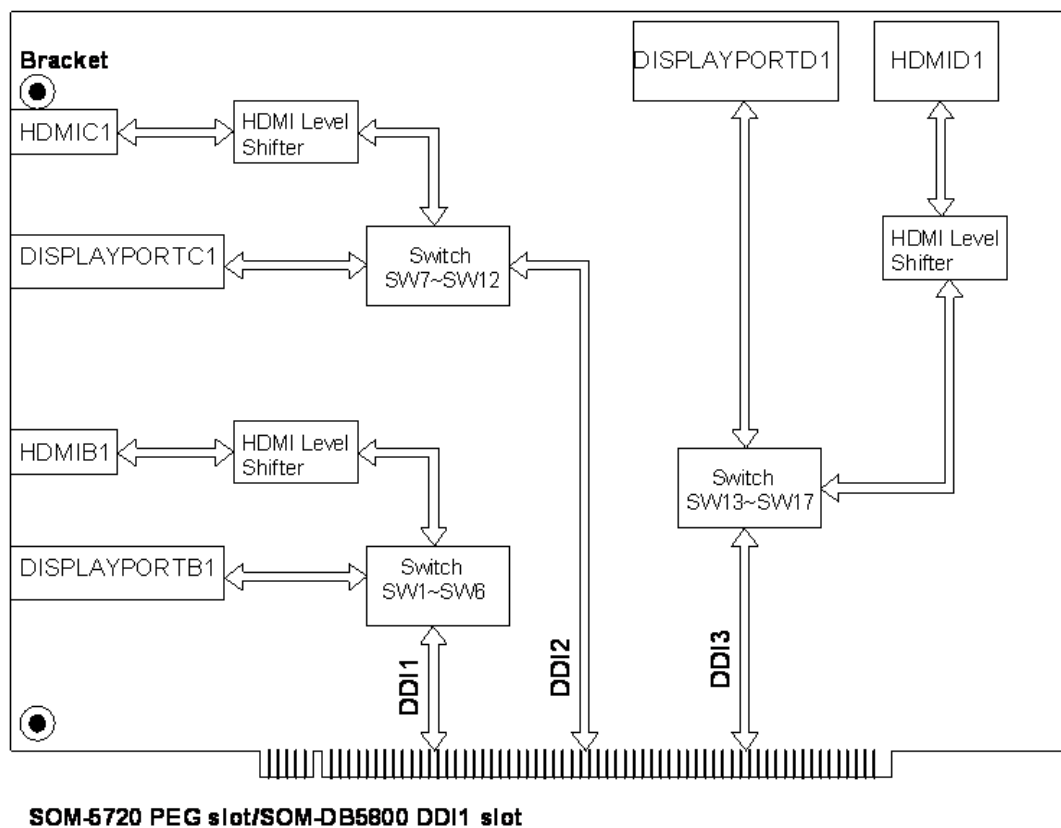
**Table 1.36: Connector, Jumper, Switch List**

Label	Function
DISPLAYPORTB1	DisplayPort B Connector
HDMIB1	HDMI Port B Connector
DISPLAYPORTC1	DisplayPort C Connector
HDMIC1	HDMI Port C Connector
DISPLAYPORTD1	DisplayPort D Connector
HDMID1	HDMI Port D Connector
DDI1_HPDI	DisplayPort B / HDMI Port B Hot Plug Detection
DDI2_HPDI	DisplayPort C / HDMI Port C Hot Plug Detection
DDI3_HPDI	DisplayPort D / HDMI Port D Hot Plug Detection
SW1 ~ SW6	DDI1 DisplayPort B / HDMI Port B Switch
SW7 ~ SW12	DDI2 DisplayPort C / HDMI Port C Switch
SW13 ~ SW17	DDI3 DisplayPort D / HDMI Port D Switch

**Note!** SW1 ~ SW17 has different settings for SOM-DB5800 A2 or SOM-DB5720, please see details in section 1.3.4 Switch Setting.



## 1.3.2 SOM-EA20 Block Diagram



## 1.3.3 Golden Finger Pin Definition

**Table 1.37: DDI1 Digital Display Interface Pin Definition**

Pin	Signal
A1	HDMIC_CTRL_CLK
A2	+V12
A3	+V12
A4	GND
A5	NC
A6	NC
A7	NC
A8	NC
A9	+V3.3
A10	+V3.3
A11	PLTRST#
A12	GND
A13	NC
A14	NC
A15	GND
A16	NC
A17	NC
A18	GND
A19	NC

Table 1.37: DDI1 Digital Display Interface Pin Definition	
A20	GND
A21	NC
A22	NC
A23	GND
A24	GND
A25	DPB_AUXP_C
A26	DPB_AUXN_C
A27	GND
A28	GND
A29	DDI1_HPD
A30	NC
A31	GND
A32	NC
A33	NC
A34	GND
A35	DDI1_CTRLCLK_AUX+
A36	DDI1_CTRLDATA_AUX-
A37	GND
A38	GND
A39	NC
A40	NC
A41	GND
A42	GND
A43	DDI2_CTRLCLK_AUX+
A44	DDI2_CTRLDATA_AUX-
A45	GND
A46	GND
A47	DDI2_HPD
A48	NC
A49	GND
A50	NC
A51	GND
A52	NC
A53	NC
A54	GND
A55	GND
A56	NC
A57	NC
A58	GND
A59	GND
A60	DDI3_CTRLCLK_AUX+
A61	DDI3_CTRLDATA_AUX-
A62	GND
A63	GND
A64	DDI3_HPD
A65	NC
A66	GND

**Table 1.37: DDI1 Digital Display Interface Pin Definition**

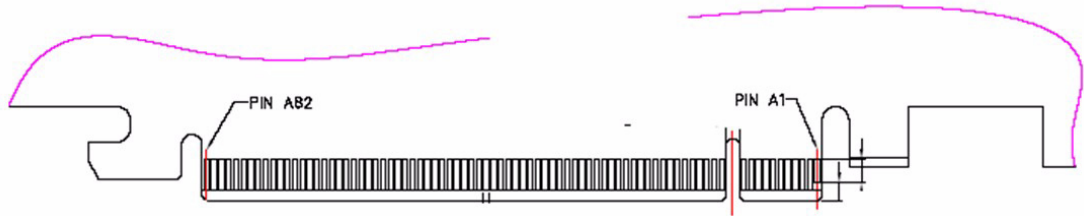
A67	GND
A68	NC
A69	NC
A70	GND
A71	GND
A72	NC
A73	NC
A74	GND
A75	GND
A76	NC
A77	NC
A78	GND
A79	GND
A80	NC
A81	NC
A82	GND

<b>Pin</b>	<b>Signal</b>
B1	+V12
B2	+V12
B3	+V12
B4	GND
B5	NC
B6	NC
B7	GND
B8	+V3.3
B9	NC
B10	+V3.3_DUAL
B11	NC
B12	NC
B13	GND
B14	DDI1_PAIR0+
B15	DDI1_PAIR0-
B16	GND
B17	HDMIB_CTRL_CLK
B18	GND
B19	DDI1_PAIR1+
B20	DDI1_PAIR1-
B21	GND
B22	GND
B23	DDI1_PAIR2+
B24	DDI1_PAIR2-
B25	GND
B26	GND
B27	DDI1_PAIR3+
B28	DDI1_PAIR3-



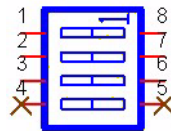
B29	GND
B30	NC
B31	HDMIB_CTRL_DATA
B32	GND
B33	DDI2_PAIR0+
B34	DDI2_PAIR0-
B35	GND
B36	GND
B37	DDI2_PAIR1+
B38	DDI2_PAIR1-
B39	GND
B40	GND
B41	DDI2_PAIR2+
B42	DDI2_PAIR2-
B43	GND
B44	GND
B45	DDI2_PAIR3+
B46	DDI2_PAIR3-
B47	GND
B48	NC
B49	GND
B50	DDI3_PAIR0+
B51	DDI3_PAIR0-
B52	GND
B53	GND
B54	DDI3_PAIR1+
B55	DDI3_PAIR1-
B56	GND
B57	GND
B58	DDI3_PAIR2+
B59	DDI3_PAIR2-
B60	GND
B61	GND
B62	DDI3_PAIR3+
B63	DDI3_PAIR3-
B64	GND
B65	GND
B66	NC
B67	NC
B68	GND
B69	GND
B70	NC
B71	NC
B72	GND
B73	GND
B74	NC
B75	NC
B76	GND

B77	GND
B78	NC
B79	NC
B80	GND
B81	HDMIC_CTRL_DATA
B82	NC



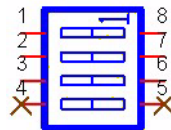
### 1.3.4 Switch Setting

#### 1.3.4.1 SOM-EA20 on SOM-DB5800 A2 DDI1 Slot



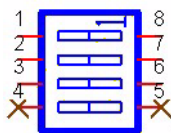
**Table 1.38: SW1 ~ SW5: DDI1 DisplayPort B / HDMI Port B Switch**

Function	Dip Switch	1-8	2-7	3-6	4-5
DDI1 DisplayPort B	SW1,SW3,SW5	OFF	OFF	OFF	OFF
	SW2	ON	ON	OFF	OFF
	SW4,SW6	ON	ON	ON	ON
DDI1 HDMI Port B	SW1	ON	ON	OFF	OFF
	SW3,SW5	ON	ON	ON	ON
	SW2,SW4,SW6	OFF	OFF	OFF	OFF



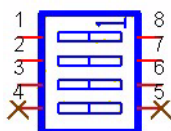
**Table 1.39: SW7 ~ SW12: DDI2 DisplayPort C / HDMI Port C Switch**

Function	Dip Switch	1-8	2-7	3-6	4-5
DDI2 DisplayPort C	SW7,SW9,SW11	OFF	OFF	OFF	OFF
	SW8	ON	ON	-	-
	SW10,SW12	ON	ON	ON	ON
DDI2 HDMI Port C	SW7	ON	ON	OFF	OFF
	SW9,SW11	ON	ON	ON	ON
	SW8,SW10,SW12	OFF	OFF	OFF	OFF

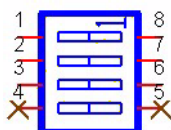

**Table 1.40: SW13 ~ SW17: DDI3 DisplayPort D / HDMI Port D Switch**

Function	Dip Switch	1-8	2-7	3-6	4-5
DDI3 DisplayPort D	SW13	OFF	ON	ON	OFF
	SW14,SW16	OFF	OFF	OFF	OFF
	SW15,SW17	ON	ON	ON	ON
DDI3 HDMI Port D	SW13	ON	OFF	OFF	ON
	SW14,SW16	ON	ON	ON	ON
	SW15,SW17	OFF	OFF	OFF	OFF

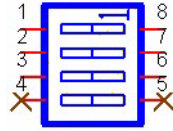
### 1.3.4.2 SOM-EA20 on SOM-DB5720 PEG Slot


**Table 1.41: SW1 ~ SW5: DDI1 DisplayPort B / HDMI Port B Switch**

Function	Dip Switch	1-8	2-7	3-6	4-5
DDI1 DisplayPort B	SW1,SW3,SW5	OFF	OFF	OFF	OFF
	SW2	OFF	OFF	ON	ON
	SW4,SW6	ON	ON	ON	ON
DDI1 HDMI Port B	SW1	OFF	OFF	ON	ON
	SW3,SW5	ON	ON	ON	ON
	SW2,SW4,SW6	OFF	OFF	OFF	OFF


**Table 1.42: SW7 ~ SW12: DDI2 DisplayPort C / HDMI Port C Switch**

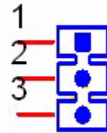
Function	Dip Switch	1-8	2-7	3-6	4-5
DDI2 DisplayPort C	SW7,SW9,SW11	OFF	OFF	OFF	OFF
	SW8	ON	ON	-	-
	SW10,SW12	ON	ON	ON	ON
DDI2 HDMI Port C	SW7	OFF	OFF	ON	ON
	SW9,SW11	ON	ON	ON	ON
	SW8,SW10,SW12	OFF	OFF	OFF	OFF



**Table 1.43: SW13 ~ SW17: DDI3 DisplayPort D / HDMI Port D Switch**

Function	Dip Switch	1-8	2-7	3-6	4-5
DDI3 DisplayPort D	SW13	OFF	ON	ON	OFF
	SW14,SW16	OFF	OFF	OFF	OFF
	SW15,SW17	ON	ON	ON	ON
DDI3 HDMI Port D	SW13	ON	OFF	OFF	ON
	SW14,SW16	ON	ON	ON	ON
	SW15,SW17	OFF	OFF	OFF	OFF

### 1.3.5 Jumper Setting



**Table 1.44: DDI1\_HPDP1: DDI1 DisplayPort B / HDMI Port B Hot Plug Selection**

Pin	Function
1-2	DDI1 DisplayPort B Hot Plug Detection
2-3	DDI1 HDMI Port B Hot Plug Detection [default]

**Table 1.45: DDI2\_HPDP1: DDI2 DisplayPort C / HDMI Port C Hot Plug Selection**

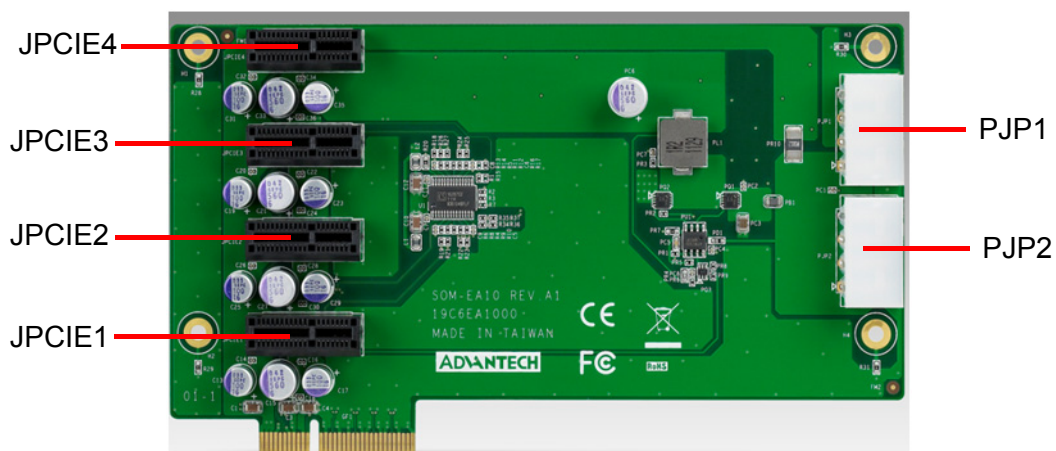
Pin	Function
1-2	DDI2 DisplayPort C Hot Plug Detection
2-3	DDI2 HDMI Port C Hot Plug Detection [default]

**Table 1.46: DDI3\_HPDP1: DDI3 DisplayPort D / HDMI Port D Hot Plug Selection**

Pin	Function
1-2	DDI3 DisplayPort D Hot Plug Detection
2-3	DDI3 HDMI Port D Hot Plug Detection [default]

## 1.4 SOM-EA10

### 1.4.1 Connector Location

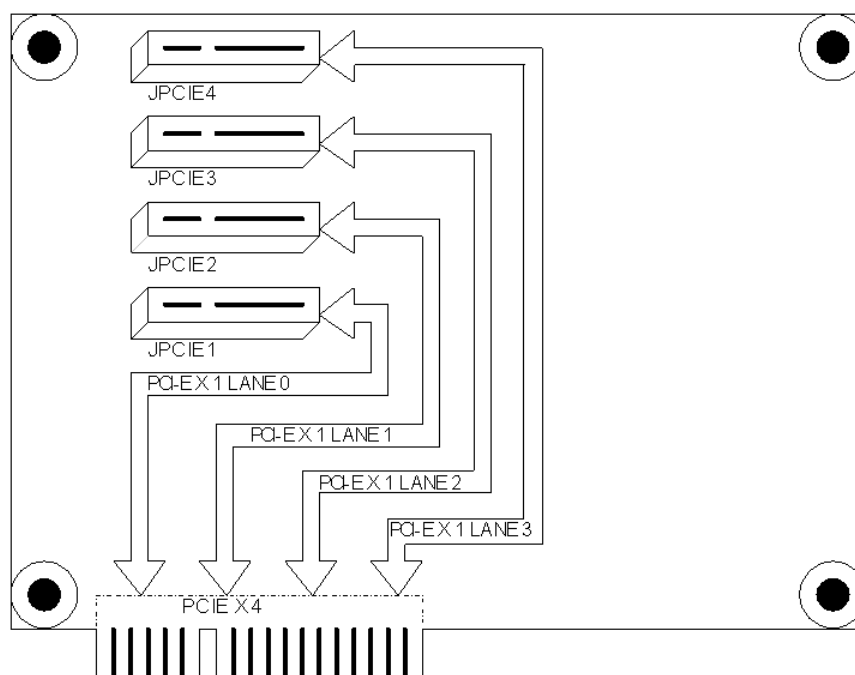


### 1.4.2 Connector List

**Table 1.47: Connector List**

Label	Function
JPCIE1	PCIe x1 Port 1 Connector
JPCIE2	PCIe x1 Port 2 Connector
JPCIE3	PCIe x1 Port 3 Connector
JPCIE4	PCIe x1 Port 4 Connector
PJP1	4P Power Connector
PJP2	4P Power Connector

### 1.4.3 SOM-EA10 Block Diagram



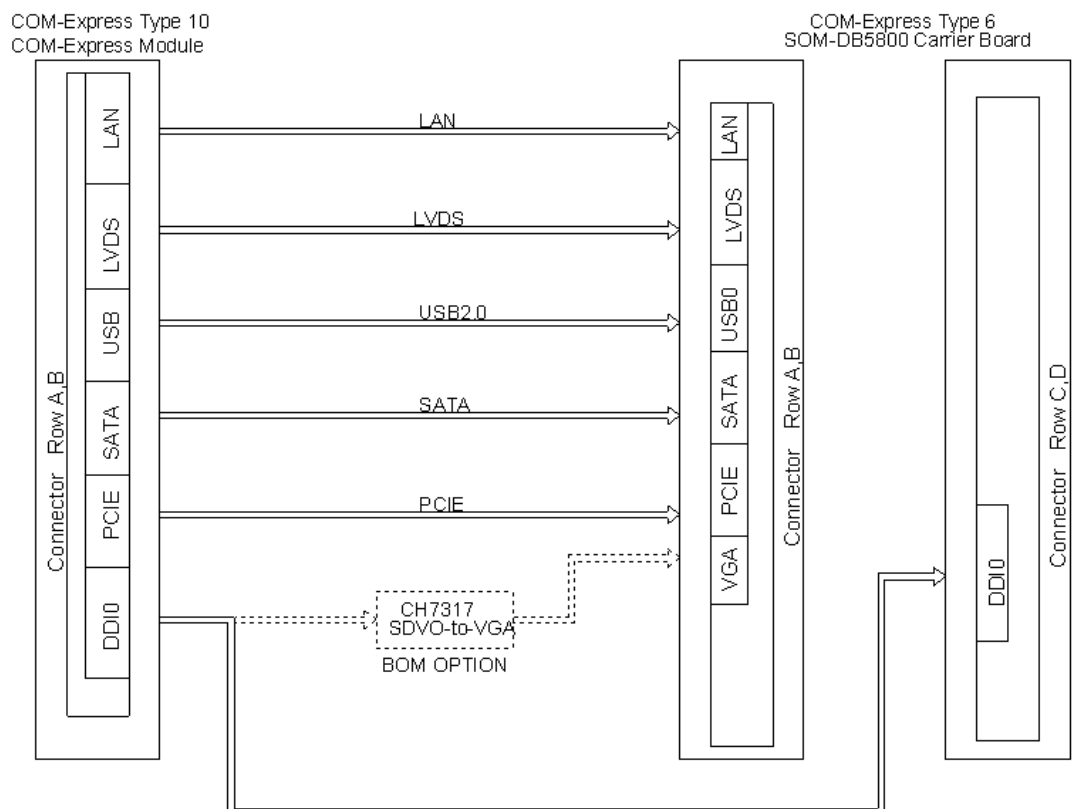
## 1.5 SOM-EA00

### 1.5.1 Connector Location

**Table 1.48: Connector List**

Label	Function
SOM-AB1	Type10 COM-Express A & B Connector
SOM2-AB	Type6 COM-Express A & B Connector
SOM2-CD	Type6 COM-Express C & D Connector

### 1.5.2 SOM-EA00 Block Diagram





**ADVANTECH**

*Enabling an Intelligent Planet*

**[www.advantech.com](http://www.advantech.com)**

Please verify specifications before quoting. This guide is intended for reference purposes only.

All product specifications are subject to change without notice.

No part of this publication may be reproduced in any form or by any means, electronic, photocopying, recording or otherwise, without prior written permission of the publisher.

All brand and product names are trademarks or registered trademarks of their respective companies.

© Advantech Co., Ltd. 2012