

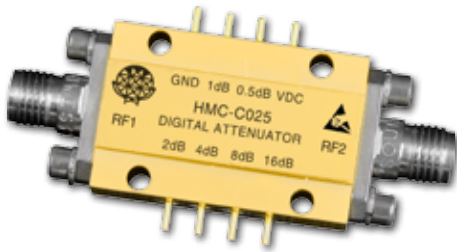

0.5dB LSB GaAs MMIC 6-BIT DIGITAL ATTENUATOR MODULE, DC - 13 GHz



Typical Applications

The HMC-C025 is ideal for:

- Telecom Infrastructure
- Military Radio, Radar & ECM
- Space Systems
- Test Instrumentation

Functional Diagram

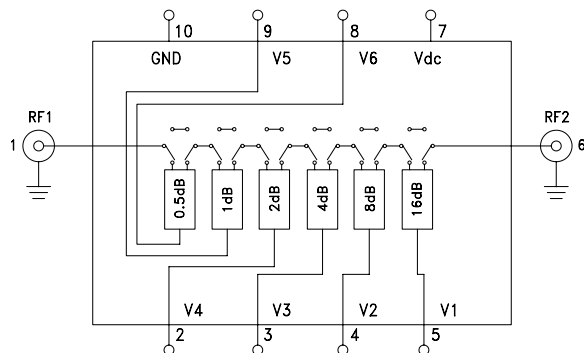

Features

- 0.5 dB LSB Steps to 31.5 dB
- Single Control Line Per Bit
- ± 0.3 dB Typical Bit Error
- CMOS Compatible Control
- Hermetically Sealed Module
- Field Replaceable SMA Connectors
- 55 °C to +85 °C Operating Temperature

General Description

The HMC-C025 is a DC to 13 GHz 6-bit GaAs IC Digital Attenuator housed in a miniature hermetic module. This wideband attenuator features 4 dB typical insertion loss, +38 dBm input IP3, and bit values of 0.5 (LSB), 1, 2, 4, 8, and 16 dB for a total attenuation of 31.5 dB. Attenuation accuracy is excellent with ±0.3 dB typical step error. Six control voltage inputs, toggled between 0 and +5V, are used to select each attenuation state. A single Vdc bias of -5V allows operation at frequencies down to DC. Removable SMA connectors can be detached to allow direct connection of the module's I/O pins to a microstrip or coplanar circuit.

Electrical Specifications, $T_A = +25^\circ\text{C}$, with $V_{dc} = -5V$ & $V_{CTL} = 0/+5V$

Parameter	Frequency (GHz)	Min.	Typ.	Max.	Units
Insertion Loss	DC - 4 GHz		3.2	3.7	dB
	4 - 8 GHz		4.2	4.7	dB
	8 - 11 GHz		5.0	5.5	dB
	11 - 13 GHz		5.5	6.0	dB
Attenuation Range	DC - 13 GHz		31.5		dB
Return Loss (RF1 & RF2, All Atten. States)	DC - 13 GHz		12		dB
Attenuation Accuracy: (Referenced to Insertion Loss) All States	DC - 3 GHz	± (0.2 + 3% of Atten. Setting) Max			dB
	3 - 10 GHz	± (0.4 + 3% of Atten. Setting) Max			dB
	3 - 10 GHz	± (0.4 + 4% of Atten. Setting) Max			dB
	10 - 13 GHz	± (0.6 + 10% of Atten. Setting) Max			dB
Input Power for 0.1 dB Compression	1 - 13 GHz		22		dBm
Input Third Order Intercept Point (Two-Tone Input Power= 0 dBm Each Tone)	1 - 13 GHz	RF State	46		dBm
		All Other States	38		dBm
Switching Characteristics	DC - 13 GHz				
tRISE, tFALL (10/90% RF)			22		ns
tON/OFF (50% CTL to 10/90% RF)			45		ns

HMC-C025* PRODUCT PAGE QUICK LINKS

Last Content Update: 02/23/2017

COMPARABLE PARTS

View a parametric search of comparable parts.

DOCUMENTATION

Data Sheet

- HMC-C025 Data Sheet

TOOLS AND SIMULATIONS

- HMC-C025 S-Parameter

REFERENCE MATERIALS

Technical Articles

- Hittite Launches HMC-T2100 10 MHz to 20 GHz Synthesized Signal Generator

DESIGN RESOURCES

- HMC-C025 Material Declaration
- PCN-PDN Information
- Quality And Reliability
- Symbols and Footprints

DISCUSSIONS

View all HMC-C025 EngineerZone Discussions.

SAMPLE AND BUY

Visit the product page to see pricing options.

TECHNICAL SUPPORT

Submit a technical question or find your regional support number.

DOCUMENT FEEDBACK

Submit feedback for this data sheet.



0.5dB LSB GaAs MMIC 6-BIT DIGITAL ATTENUATOR MODULE, DC - 13 GHz

Insertion Loss

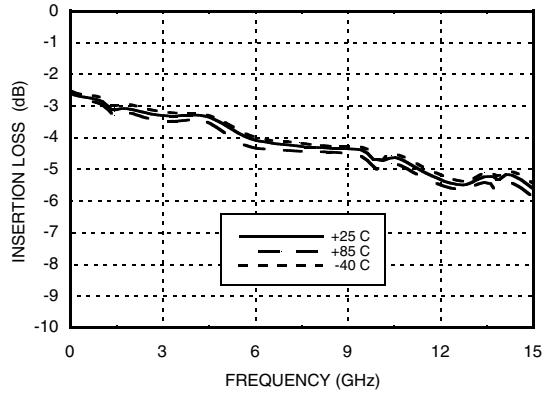

Return Loss RF1, RF2
(Only Major States are Shown)

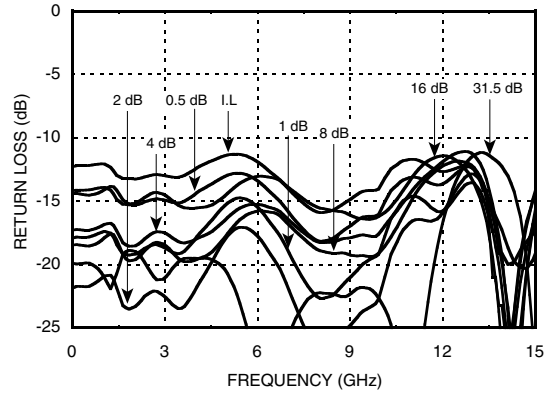

Normalized Attenuation
(Only Major States are Shown)

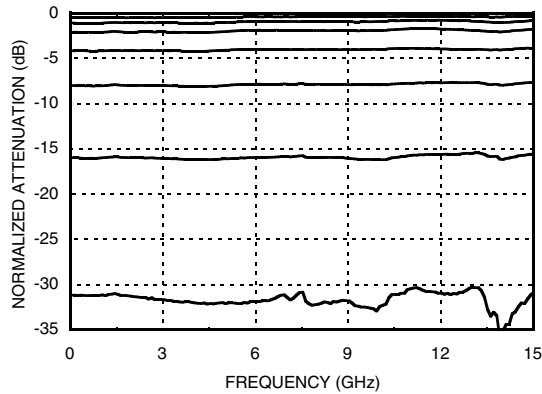

Bit Error vs. Attenuation State

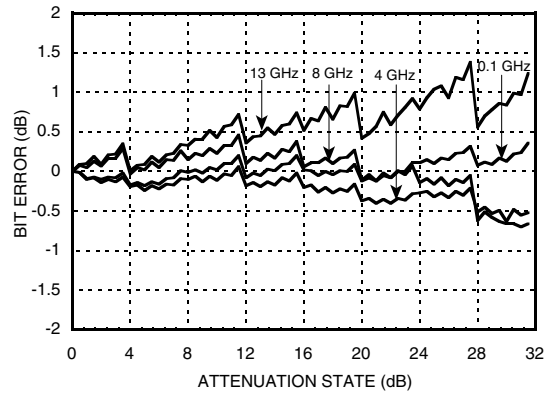

Bit Error vs. Frequency
(Only Major States are Shown)

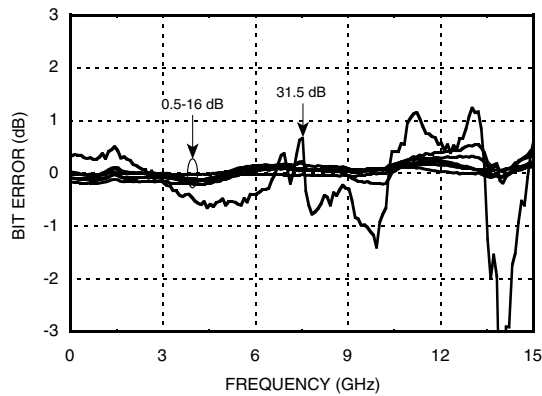

Relative Phase vs. Frequency
(Only Major States are Shown)

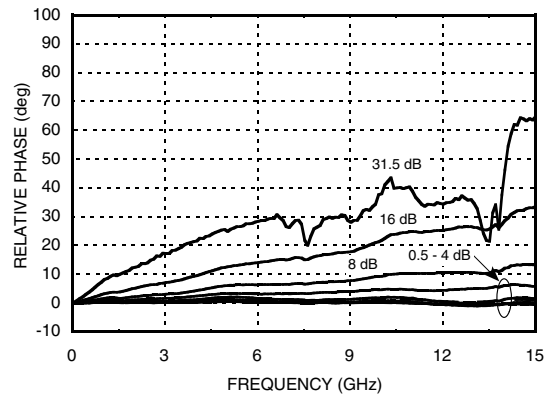

Information furnished by Analog Devices is believed to be accurate and reliable. However, no responsibility is assumed by Analog Devices for its use, nor for any infringements of patents or other rights of third parties that may result from its use. Specifications subject to change without notice. No license is granted by implication or otherwise under any patent or patent rights of Analog Devices. Trademarks and registered trademarks are the property of their respective owners.

For price, delivery, and to place orders: Analog Devices, Inc., One Technology Way, P.O. Box 9106, Norwood, MA 02062-9106 Phone: 781-329-4700 • Order online at www.analog.com Application Support: Phone: 1-800-ANALOG-D



0.5dB LSB GaAs MMIC 6-BIT DIGITAL ATTENUATOR MODULE, DC - 13 GHz

Worst Case Step Error Between Successive Attenuation States

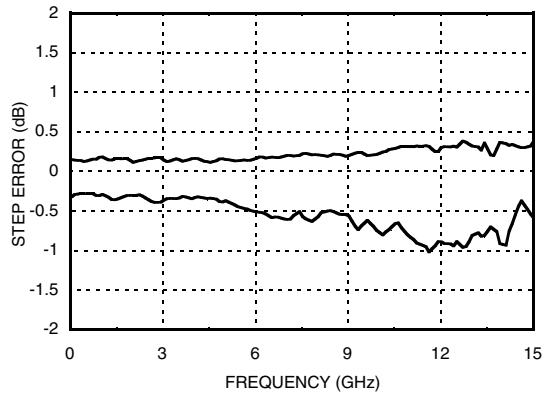

Bias Voltage & Current

Vdc Range = -5V ± 10%		
V	I (Typ.) (mA)	I (Max.) (mA)
-5.0	5	9

(Bias current increases with switching rate to 15 - 20 mA)

Control Voltage (CMOS Compatible)

State	Bias Condition
Low	0 to +1.5V @ 5 µA Typ.
High	+3.5 to +5V @ 800 µA Typ.

Truth Table

Control Voltage Input						Attenuation State RF1 - RF2
V1 16 dB	V2 8 dB	V3 4 dB	V4 2 dB	V5 1 dB	V6 0.5 dB	
Low	Low	Low	Low	Low	Low	Reference I.L.
Low	Low	Low	Low	Low	High	0.5 dB
Low	Low	Low	Low	High	Low	1 dB
Low	Low	Low	High	Low	Low	2 dB
Low	Low	High	Low	Low	Low	4 dB
Low	High	Low	Low	Low	Low	8 dB
High	Low	Low	Low	Low	Low	16 dB
High	High	High	High	High	High	31.5 dB

Any combination of the above states will provide an attenuation approximately equal to the sum of the bits selected.

Absolute Maximum Ratings

RF Input Power (0.5 - 13 GHz)	+25 dBm
Control Voltage (V1 to V6)	-0.5V to +5.5V
Bias Voltage (Vdc)	-7V
Thermal Resistance	346 °C/W
Maximum Junction Temperature	150 °C
Storage Temperature	-65 to + 150 °C
Operating Temperature	-55 to +85 °C



**ELECTROSTATIC SENSITIVE DEVICE
OBSERVE HANDLING PRECAUTIONS**

0.5dB LSB GaAs MMIC 6-BIT DIGITAL ATTENUATOR MODULE, DC - 13 GHz



Outline Drawing

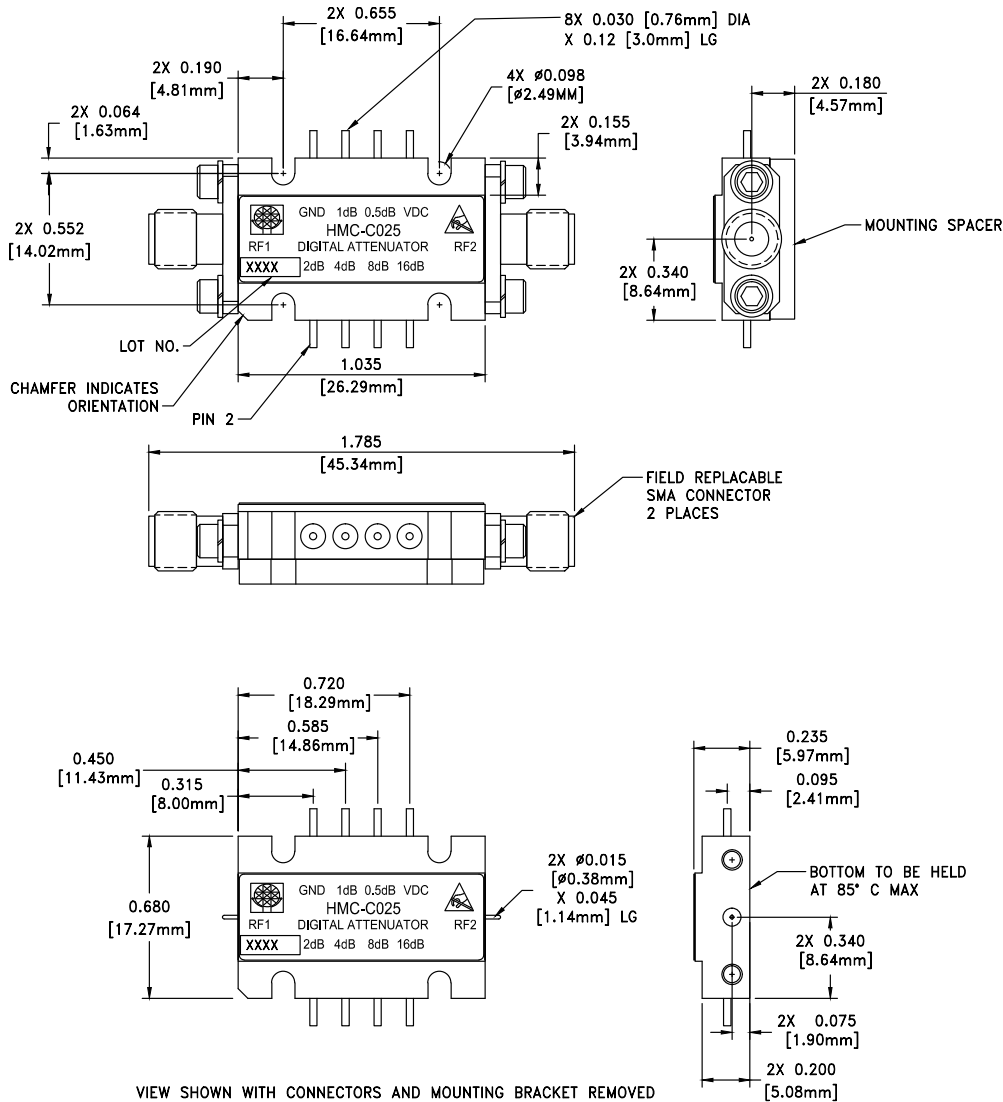

Package Information

Package Type	C-6
Package Weight [1]	17.4 gms [2]
Spacer Weight	3 gms [2]

[1] Includes the connectors

[2] \pm 1 gms Tolerance



NOTES:

1. PACKAGE, LEADS, COVER MATERIAL: KOVAR™
2. PLATING: ELECTROLYTIC GOLD 50 MICROINCHES MIN., OVER ELECTROLYTIC NICKEL 75 MICROINCHES MIN
3. MOUNTING SPACER: NICKEL PLATED ALUMINUM
4. ALL DIMENSIONS ARE IN INCHES [MILLIMETERS]
5. TOLERANCES \pm 0.010 [0.25] UNLESS OTHERWISE SPECIFIED
6. FIELD REPLACEABLE SMA CONNECTORS TENSOLITE 5602 - 5CCSF OR EQUIVALENT
7. TO MOUNT MODULE TO SYSTEM PLATFORM REPLACE 0 -80 HARDWARE WITH DESIRED MOUNTING SCREWS

0.5dB LSB GaAs MMIC 6-BIT DIGITAL ATTENUATOR MODULE, DC - 13 GHz

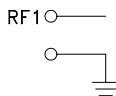
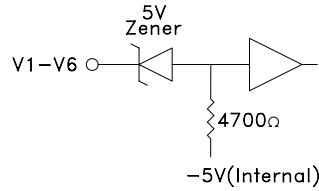
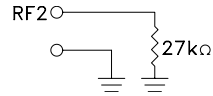

Pin Description

Pin Number	Function	Description	Interface Schematic
1	RF1	This pin is DC coupled and matched to 50 Ohms. Blocking capacitors are required if RF line potential is not equal to 0 Vdc.	
5, 4, 3, 2, 9, 8	V1 - V6	See truth table and control voltage table.	
6	RF2	This pin is DC coupled and matched to 50 Ohms. Blocking capacitors are required if RF line potential is not equal to 0 Vdc.	
7	Vdc	Supply voltage: -5 Vdc \pm 10%.	
10	GND	Power Supply Ground	



v07.0711

HMC-C025**0.5dB LSB GaAs MMIC 6-BIT DIGITAL
ATTENUATOR MODULE, DC - 13 GHz****2****ATTENUATORS**