

SRPE-30E1A0 Series

Non-Isolated DC-DC Converter

The Bel SRPE-30E1A0 is part of the non-isolated DC-DC converter Power Module series. The modules use a Vertical SMT package. These converters are available in a range of output voltages from 0.6 VDC to 2.0 VDC over a wide range of input voltage ($V_{in} = 4.5 - 13.2$ VDC).



Key Features & Benefits

- 4.5 VDC – 13.2 VDC Input
- 0.6 VDC – 2.0 VDC / 30 A Output
- Non-Isolated
- Wide Output Trim Range
- Fixed frequency
- Output Over-Voltage Shutdown
- High efficiency
- OCP/SCP
- High Power Density
- Power Good Signal
- Overtemperature Shutdown
- Remote Sense
- Wide Input Voltage Range
- Remote On/Off
- Low Cost
- Undervoltage lockout
- Wide Operating Temperature Range (0 °C - 50 °C)
- Class II, Category 2, Non-Isolated DC/DC Converter (refer to IPC-9592B)



Applications

- Networking
- Computers and Peripherals
- Telecommunications



bel POWER
SOLUTIONS &
PROTECTION

a bel group

belfuse.com/power-solutions

1. MODEL SELECTION

OUTPUT VOLTAGE	INPUT VOLTAGE	MAX. OUTPUT CURRENT	MAX. OUTPUT POWER	TYPICAL EFFICIENCY	MODEL NUMBER ACTIVE HIGH
0.6 VDC – 2.0 VDC	4.5 VDC - 13.2 VDC	30 A	60 W	91.5%	SRPE-30E1A0

NOTE: 1. Add “G” or “R” suffix at the end of the model numbers for package.

PART NUMBER EXPLANATION

S	R	PE	-	30	E	1A	0	x
Mounting type	RoHS Status	Series name		Output current	Input range	Output voltage	Active logic and HSK feature	Package type
Surface mount	RoHS 6	SMD SIP		30A	4.5-13.2V	0.6-2.0V	active high, with HSK	G – Tray R – Tape and Reel

2. ABSOLUTE MAXIMUM RATINGS

PARAMETER	DESCRIPTION	MIN	TYP	MAX	UNITS
Continuous non-operating Input Voltage		-0.3	-	15	V
Output Enable Terminal Voltage		-0.3	-	15	V
Ambient Temperature		0	-	50	°C
Storage Temperature		-40	-	125	°C
Altitude		-	-	2000	m

NOTE: Ratings used beyond the maximum ratings may cause a reliability degradation of the converter or may permanently damage the device.

3. INPUT SPECIFICATIONS

PARAMETER	DESCRIPTION	MIN	TYP	MAX	UNIT
Input Voltage		4.5	12	13.2	V
Input Current (full load)		-	-	15.0	A
Input Current (no load)	All Vin, Vout=0.6V, At Ta=25 °C.	-	20	35	mA
	All Vin, Vout=1.2V, At Ta=25 °C.	-	35	50	
	All Vin, Vout=2V, At Ta=25 °C.	-	45	70	
Remote Off Input Current		-	100	150	mA
Input Reflected Ripple Current (rms)	Vout = 2V, Iout = 30A.	-	-	30	mA
Input Reflected Ripple Current (pk-pk)	With simulated source impedance of 1μH, 5Hz to 20MHz. Use a 100μF/100V electrolytic capacitors with ESR < 0.2ohm max @ 25C.	-	-	100	mA
Turn-on Voltage Threshold	Ta=20 °C-50 °C	3.8	4.3	5	V
	The turn on voltage should not be less than 7V when Ta=0 °C-20 °C.	7	8	9	V
Turn-off Voltage Threshold		3.8	4.1	4.5	V

NOTE: All specifications are typical at 25 °C unless otherwise stated

4. OUTPUT SPECIFICATIONS

PARAMETER	DESCRIPTION	MIN	TYP	MAX	UNIT
Output Voltage Set Point	$V_{o,set} \geq 0.9VDC$	-2	-	2	%Vo,set
	$V_{o,set} < 0.9VDC$	-3	-	3	
Load Regulation	$V_{in}=38-55V$, $I_o=100\%$ load	-	25	40	mV
Line Regulation	$V_{in}=42/50V$, $I_o=0-100\%$ load (The output droop voltage from no load to full load is about 0.6V).	-	0.6	0.65	V
Regulation Over Temperature		-2	-	2	%Vo,set
Output Ripple and Noise (pk-pk)	Condition: $V_{in}=12V$, $I_{out}=\text{full load}$, $T_a=25^\circ C$; measured with a $10\mu F+7*100\mu F$ ceramic cap and	-2	-	2	%Vo,set
Output Ripple and Noise (rms)	$3*470\mu F$ POSCAP ESR $\leq 12\text{mohm}$ at output.	-	± 3	-	%Vo,set
Output Current Range		-	-	30	mV
Output DC Current Limit		-	-	5	mV
Turn On Time		-	-	5	ms
Overshoot at Turn On		-	0	5	%
Output Capacitance		470	-	9000	μF
TRANSIENT RESPONSE					
ΔV 50% ~ 75% of Max Load	Overshoot	-	40	60	mV
	Settling Time	-	20	50	μs
ΔV 75% ~ 50% of Max Load	Overshoot	-	40	60	mV
	Settling Time	-	20	50	μs

NOTE: All specifications are typical, at 25°C unless otherwise stated.

5. GENERAL SPECIFICATIONS

PARAMETER	DESCRIPTION	MIN	TYP	MAX	UNIT
Efficiency	$V_o=0.6V$, $T_a=25^\circ C$	79	80	-	%
	$V_o=1.2V$, $T_a=25^\circ C$	86	87.7	-	
	$V_o=2V$, $T_a=25^\circ C$	90	91.5	-	
Switching Frequency		-	500	-	kHz
Over Temperature Protection		-	125	-	°C
Output Voltage Trim Range(Wide Trim)	This voltage is achieved by trimming up output slowly.	0.6	-	2	V
Weight		-	10.4	-	g
MTBF	Calculated Per Telcordia SR-332, Issue 3 ($V_{in}=12V$, $V_o=0.9V$, $I_o=30A$, $T_a=40^\circ C$, with 300 LFM, $FIT=10^9/MTBF$)	-	71.7	-	Mhrs
FIT		-	13.9	-	-
Dimensions (L x W x H)			1.20 x 0.65 x 0.59		in
			30.48 x 16.51 x 15.00		mm

NOTE: All specifications are typical, at 25°C unless otherwise stated.



Asia-Pacific
+86 755 298 85888

Europe, Middle East
+353 61 225 977

North America
+1 408 785 5200

6. CONTROL SPECIFICATIONS

PARAMETER	DESCRIPTION	MIN	TYP	MAX	UNIT
Remote ON/OFF					
Signal Low (Unit Off)	Remote On/Off pin open, unit off.	0	-	1.5	V
Signal High (Unit On)		1.8	-	15	V

7. EFFICIENCY DATA

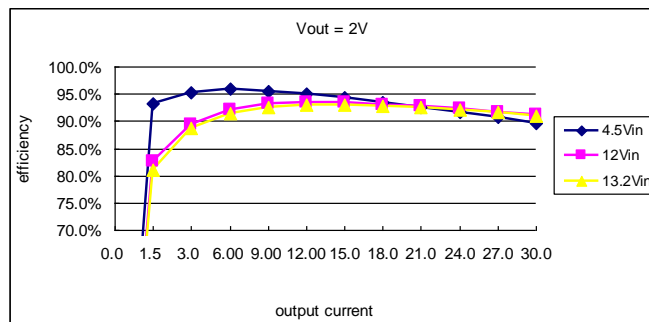
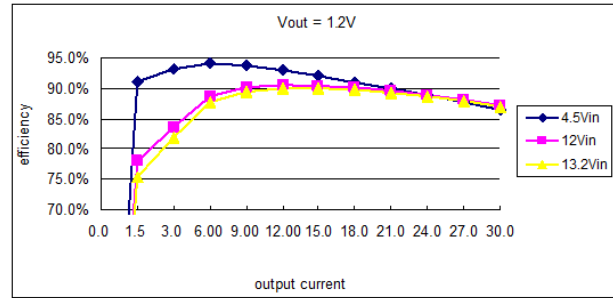
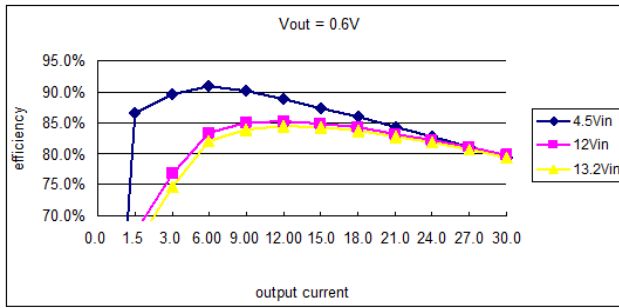

8. INPUT NOISE

Input Reflected Ripple Current

Testing setup

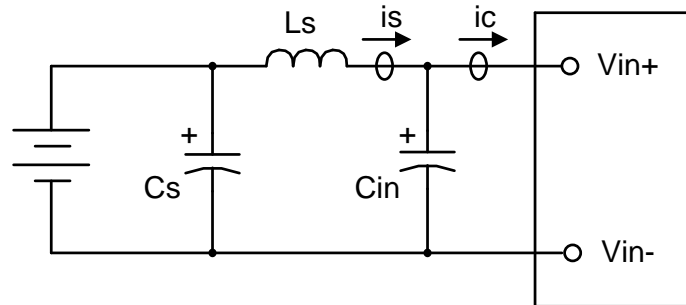

NOTES AND VALUES IN TESTING:

is: Input Reflected Ripple Current

ic: Input Terminal Ripple Current

Ls: Simulated Source Impedance (1 μ H)

Cs: Offset possible source Impedance (100 μ F, ESR<0.2 Ω @ 100kHz, 20 °C)

Cin: Electrolytic capacitor, should be as closed as possible to the power module to swallow ic ripple current and help with stability. Recommendation: 100 μ F, ESR<0.2 Ω @ 100kHz, 20 °C.

Below measured waveforms are based on above simulated and recommended inductance and capacitance.

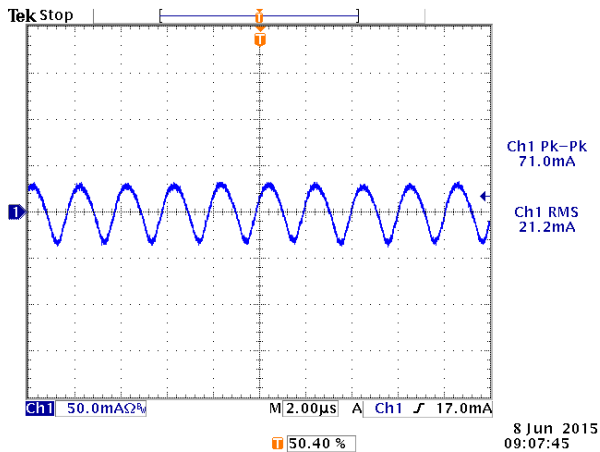

Figure 1. *is* (input terminal ripple current), AC component

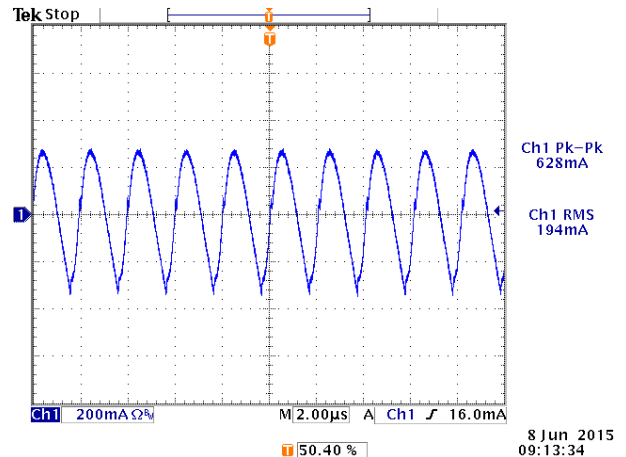

Figure 2. *ic* (input terminal ripple current), AC component

NOTE : Vin=12V,Vo=2V,Io=30A,with 1*10 μ F ceramic and 1*470 μ F polymer capacitor at the output, Ta=25 ° C.

9. THERMAL DERATING CURVES

Hot spot location and allowed maximum temperature

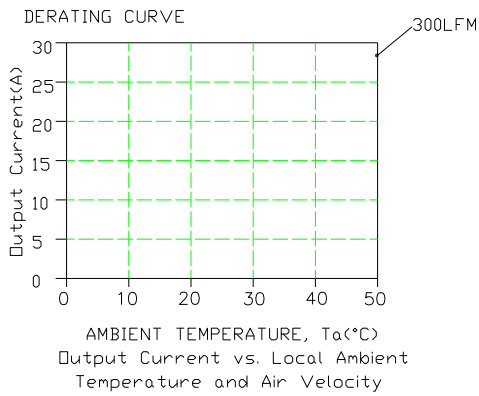
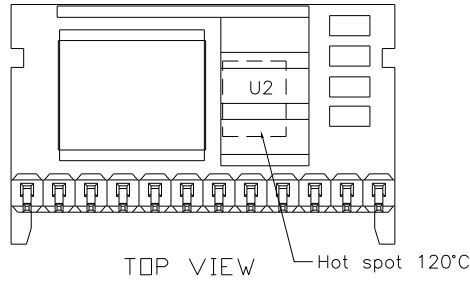

Figure 3. $V_{in} = 12V, .06V \leq V_o < 1.2V$

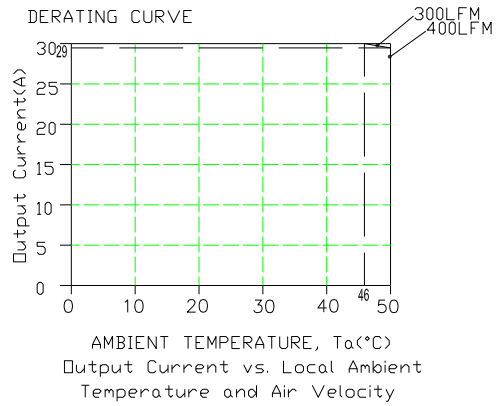

Figure 4. $V_{in} = 12V, 1.2V \leq V_o < 2V$

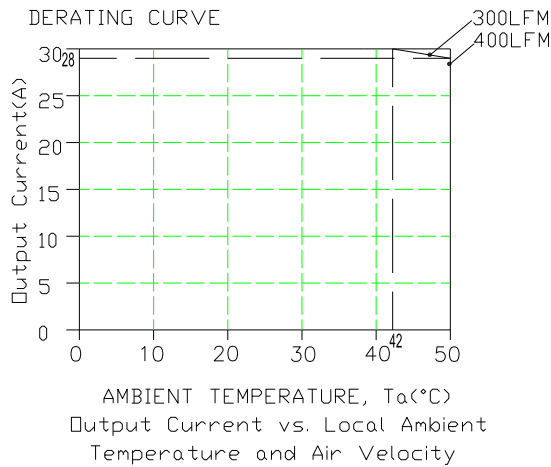
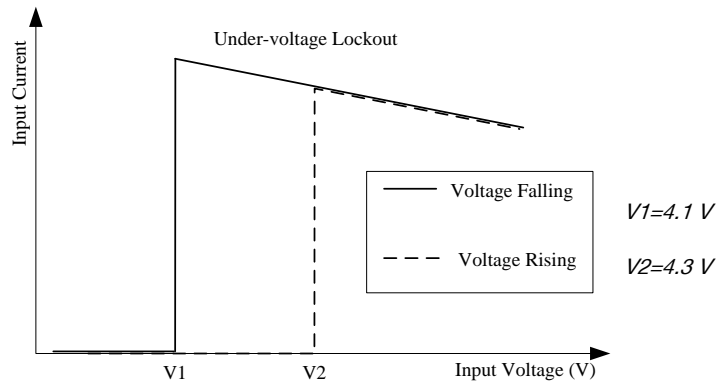

Figure 5. $V_{in} = 12V, V_o = 2V$

10. INPUT UNDER-VOLTAGE LOCKOUT



11. RIPPLE AND NOISE WAVEFORM

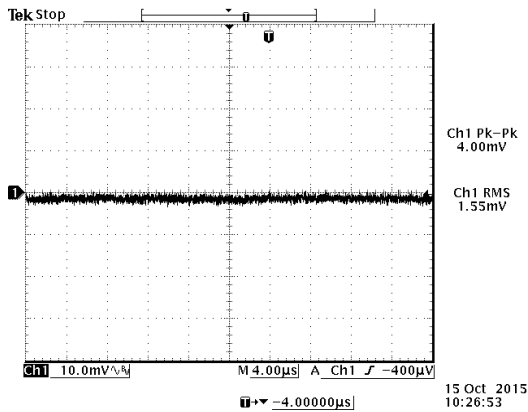

Figure 6. Ripple and noise at full load, 12VDC input 0.6VDC/30A output and $T_a=25^\circ\text{C}$

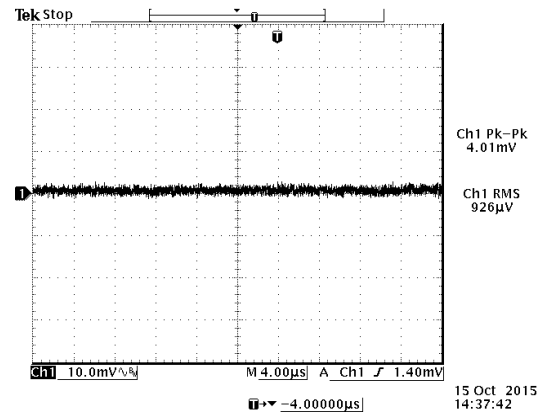

Figure 7. Ripple and noise at full load, 12VDC input 0.9VDC/30A output and $T_a=25^\circ\text{C}$

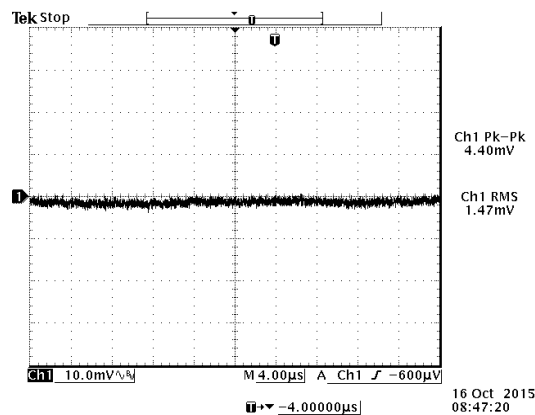

Figure 8. Ripple and noise at full load, 12VDC input 2.0VDC/30A output and $T_a=25^\circ\text{C}$

NOTE: Test condition of the output ripple and noise:
0-20MHz BW, with a 10µF+7*100µF ceramic cap and 3*470µF POSCAP ESR <= 12mohm at output.

12. TRANSIENT RESPONSE WAVEFORMS

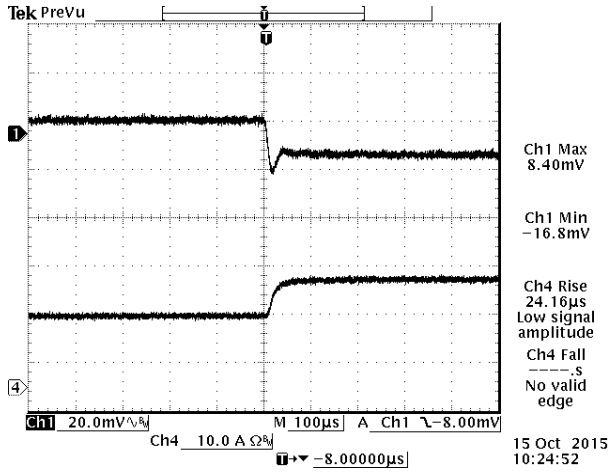

Figure 9. V_{in} = 50%-75% Load Transient at V_{in} = 12 VDC
 V_{out} = 0.6 VDC @ T_a = 25 °C

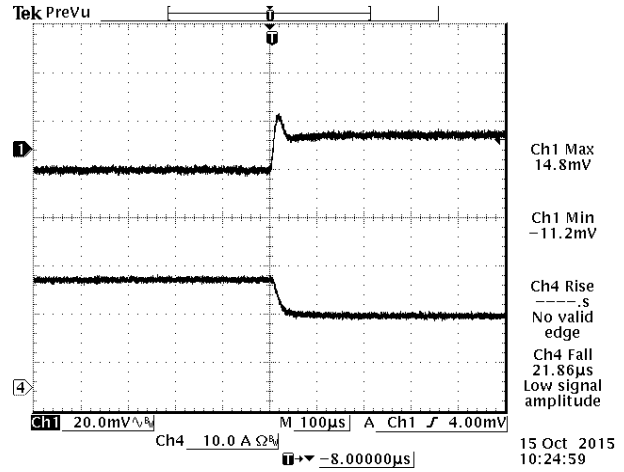

Figure 10. V_{in} = 75% - 50% Load Transient at V_{in} = 12 VDC
 V_{out} = 0.6 VDC @ T_a = 25 °C

Figure 11. V_{in} = 50%-75% Load Transient at V_{in} = 12 VDC
 V_{out} = 0.9 VDC @ T_a = 25 °C

Figure 12. V_{in} = 75% - 50% Load Transient at V_{in} = 12 VDC
 V_{out} = 0.9 VDC @ T_a = 25 °C

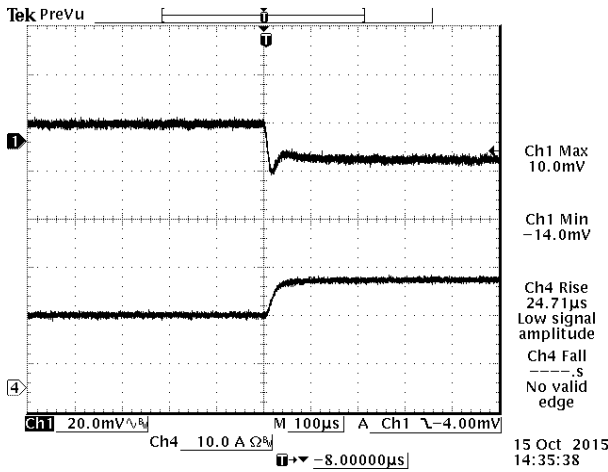

Figure 13. V_{in} = 50%-75% Load Transient at V_{in} = 12 VDC
 V_{out} = 2.0 VDC @ T_a = 25 °C

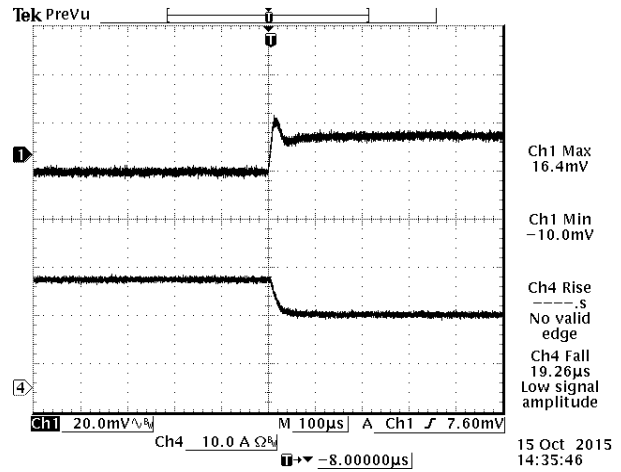

Figure 14. V_{in} = 75% - 50% Load Transient at V_{in} = 12 VDC
 V_{out} = 2.0VDC @ T_a = 25 °C

NOTE: Test condition of the Transient response:
 di/dt = 2.5A/ μ s, with a 10 μ F + 7*100 μ F ceramic cap and 3*470 μ F POSCAP ESR <= 12mohm at output.

13. STARTUP & SHUTDOWN

RISE TIME

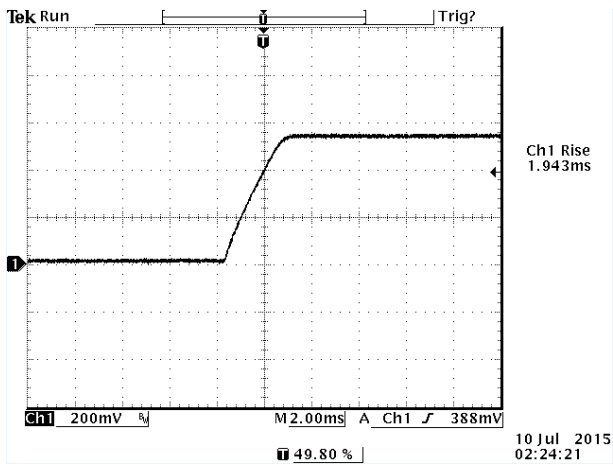

Figure 15. Rise time at full load, 12VDC input 0.6VDC/30A output and $T_a=25^\circ\text{C}$

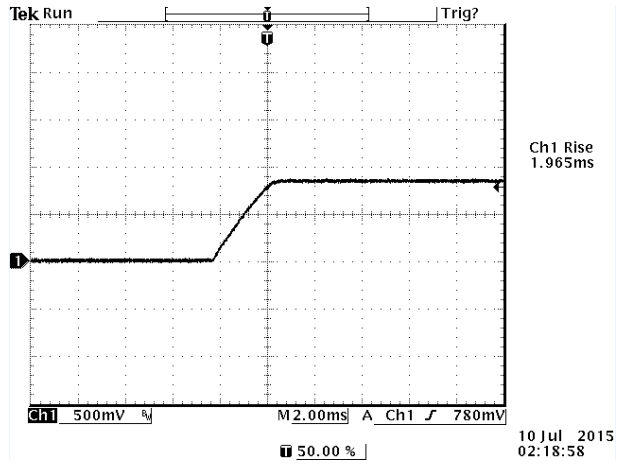

Figure 16. Rise time at full load, 12VDC input 0.9VDC/30A output and $T_a=25^\circ\text{C}$

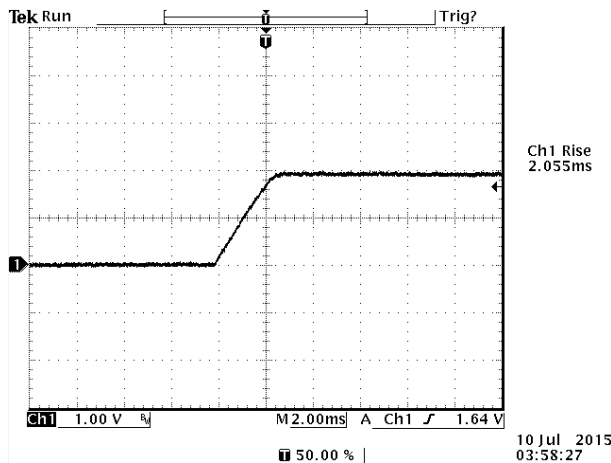

Figure 17. Rise time at full load, 12VDC input 2.0VDC/30A output and $T_a=25^\circ\text{C}$

NOTE: Test condition of the Rise time:

$di/dt=2.5\text{A}/\mu\text{s}$, with a $10\mu\text{F}+7*100\mu\text{F}$ ceramic cap and $3*470\mu\text{F}$ POSCAP ESR $\leq 12\text{mohm}$ at output.

STARTUP TIME

Startup from remote on/off

Ch1: V_o

Ch3: remote on/off

Test Condition:

With a $10\mu\text{F}+7*100\mu\text{F}$ ceramic cap and $3*470\mu\text{F}$ POSCAP ESR

$\leq 12\text{mohm}$ at output.

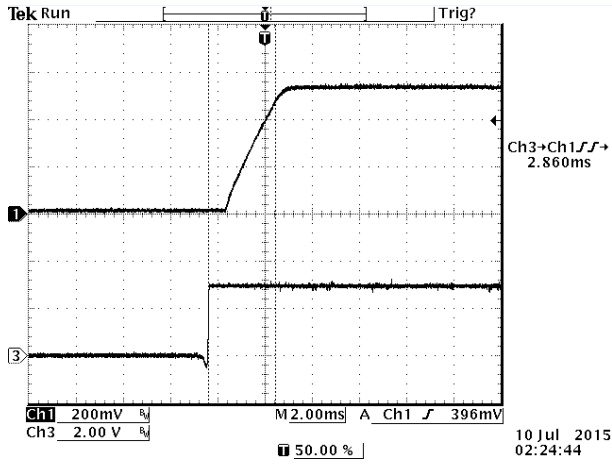

Figure 18. Start up time at full load, 12VDC input
0.6VDC/30A output and Ta=25 °C

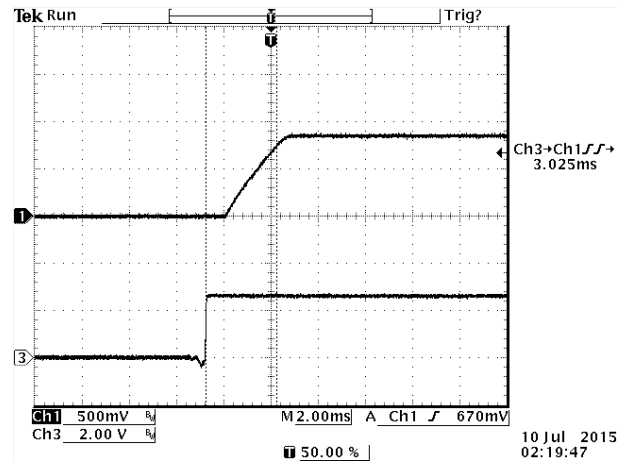

Figure 19. Start up time at full load, 12VDC input
0.9VDC/30A output and Ta=25 °C

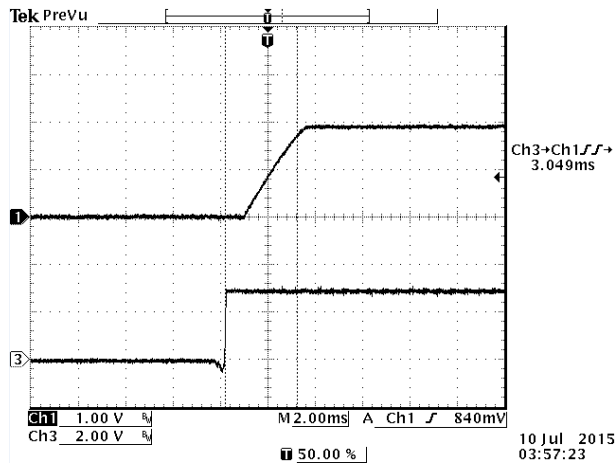

Figure 20. Start up time at full load, 12VDC input
2.0VDC/30A output and Ta=25 °C

14. TRIM

Output Voltage Set-Point Adjustment
 Maximum trim up voltage is 2V.
 Minimum trim up voltage is 0.6V.

Trim up circuit (using an external resistor)

Equations for calculating the trim resistor are shown below.
 The Trim Up resistor should be connected between the Trim pin and the GND.
 SRP1-30E1A0 Trim up Resistor Calculate
 Unit: KΩ
 Vo is the desired output voltage
 Rtrimup is the required resistance between TRIM and GND

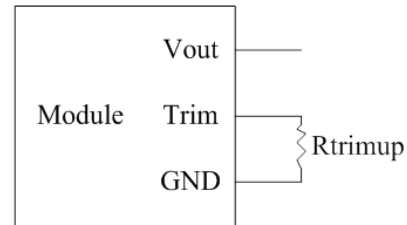
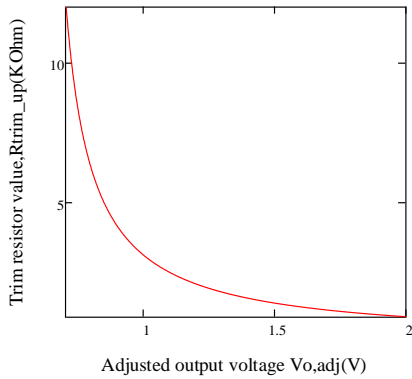

$$R_{trimup} = \frac{1.2}{V_o - 0.6}$$

Trim up circuit (using external PWM signal)

Equations for calculating the duty cycle are shown below

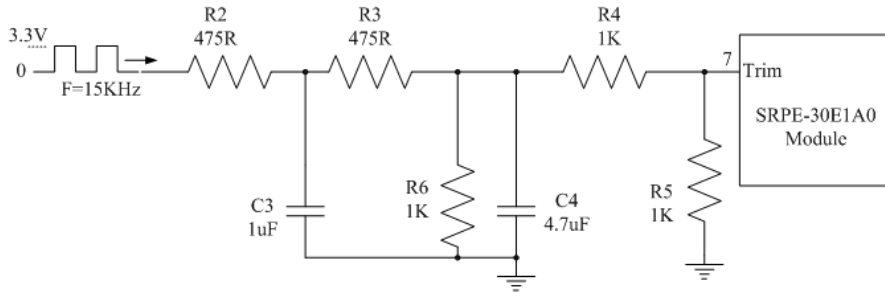

$$V_o(D) = 2.72 - 0.0234D$$

SRP1-30E1A0 Trim up duty cycle Calculate Unit: %
 Vo is the desired output voltage
 D is the external PWM signal duty cycle.

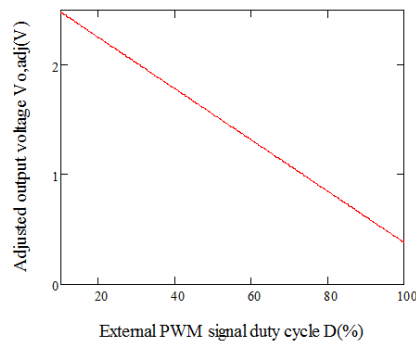

15. OCP

To provide protection in a fault output overload condition, the module is equipped with internal current-limiting circuitry and can endure current limiting for a few milli-seconds. If the overcurrent condition persists beyond a few milliseconds, the module will shut down into hiccup mode and restart once every 40mS. The module operates normally when the output current goes into specified range. The typical average output current is 4A during hiccup.

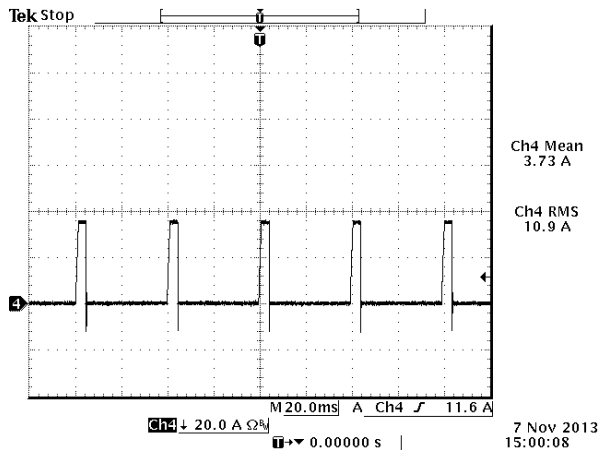

Figure 21. Output current @ SCP, $V_{in} = 12V$
 $V_{out} = 0.6V, T_a = 25^\circ C$

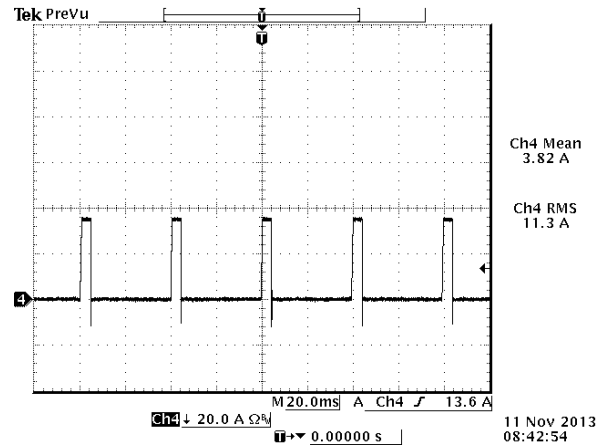

Figure 22. Output current @ SCP, $V_{in} = 12V$
 $V_{out} = 0.9V, T_a = 25^\circ C$

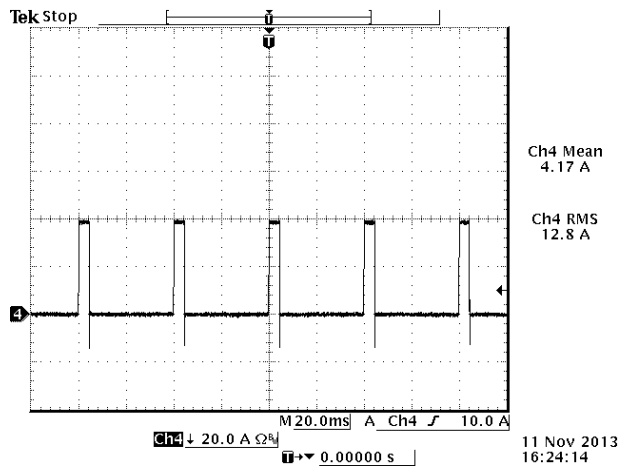

Figure 23. Output current @ SCP, $V_{in} = 12V$
 $V_{out} = 1.5V, T_a = 25^\circ C$

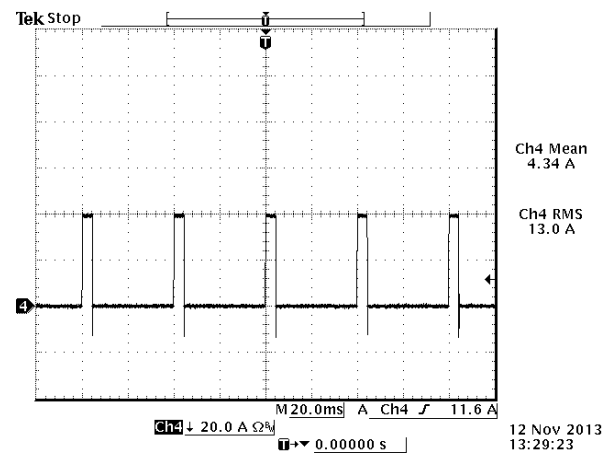

Figure 24. Output current @ SCP, $V_{in} = 12V$
 $V_{out} = 2.0V, T_a = 25^\circ C$

NOTE: Test condition of the SCP:
With a 10 μ F ceramic cap and a 470 μ F POSCAP ESR \leq 12mohm at output.

16. POWER GOOD

1. This module has a power good indicator output. Power good pin used positive logic and is open collector.
2. The maximum voltage pulled up externally on Power Good pin should not exceed 7V.
3. If the output voltage becomes within +10% and -5% of the target value, internal comparators detect power-good state and the power-good signal becomes high after a 1ms internal delay.
4. If the output voltage goes outside of +15% or -10% of the target value, the power-good signal becomes low after two microsecond (2- μ s) internal delay.
5. The pull up resistance must be larger than 10 kOhm.

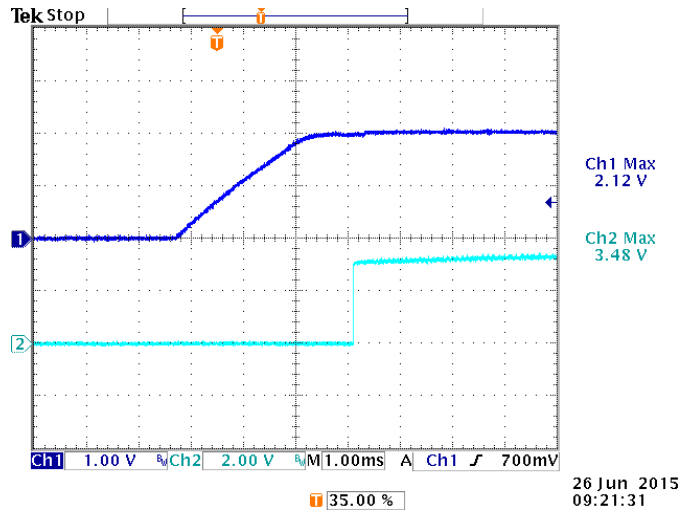
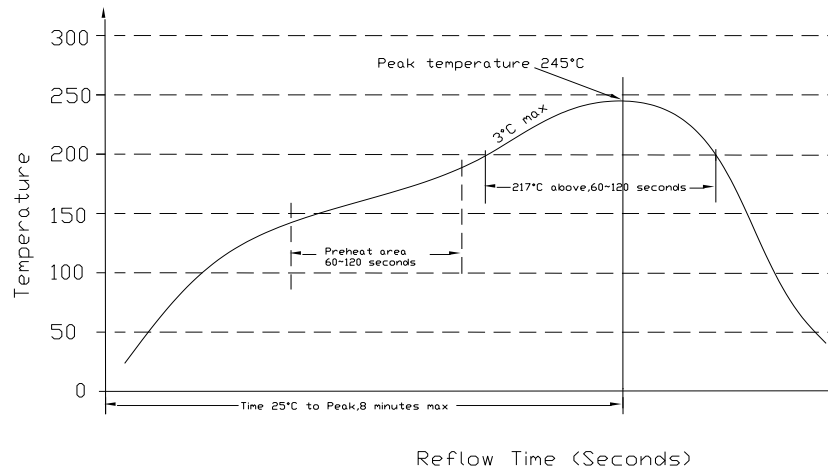

Figure 25. Typical Start-up using Remote on/off, $V_{in}=12V$, $V_o=2V$, $I_o=0A$
 CH1= V_{out}
 CH2=PG

17. SOLDERING INFORMATION

The SRPE-30E1A0 modules are designed to be compatible with reflow soldering process. The suggested Pb-free solder paste is Sn/Ag/Cu(SAC). The recommended reflow profile using Sn/Ag/Cu solder is shown in the following. Recommended reflow peak temperature is 245°C while the part can withstand peak temperature of 260°C maximum for 10 seconds. This profile should be used only as a guideline. Many other factors influence the success of SMT reflow soldering. Since your production environment may differ, please thoroughly review these guidelines with your process engineers.



18. MSL RATING

The SRPE-30E1A0 modules have a MSL rating of 3.

19. STORAGE AND HANDLING

The SRPE-30E1A0 modules are designed to be compatible with J-STD-033 Rev: A (Handling, Packing, Shipping and Use of Moisture /Reflow Sensitive surface Mount devices). Moisture barrier bags (MBB) with desiccant are applied. The recommended storage environment and handling procedure is detailed in J-STD-033.

20. PRE-BAKING

This component has been designed, handled, and packaged ready for Pb-free reflow soldering. If the assembly shop follows J-STD-033 guidelines, no pre-bake of this component is required before being reflowed to a PCB. However, if the J-STD-033 guidelines are not followed by the assembler, Bel recommends that the modules should be pre-baked @ 120~125°C for a minimum of 4 hours (preferably 24 hours) before reflow soldering.

21. MECHANICAL OUTLINE

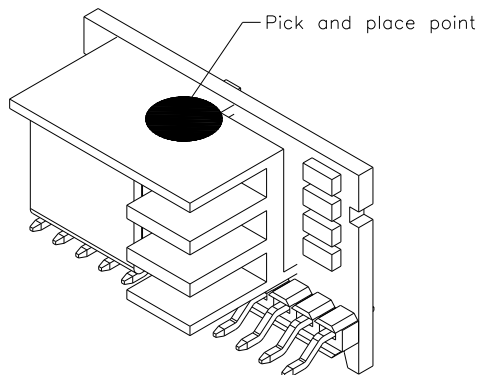
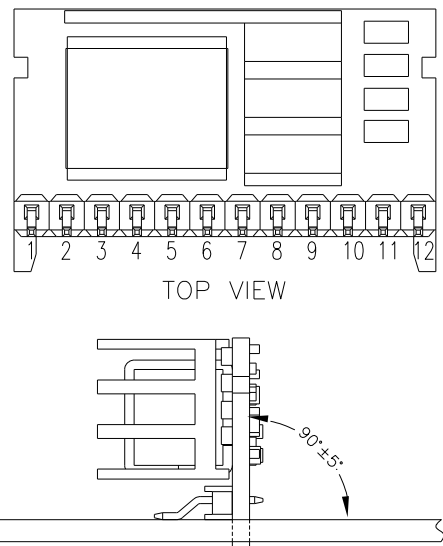
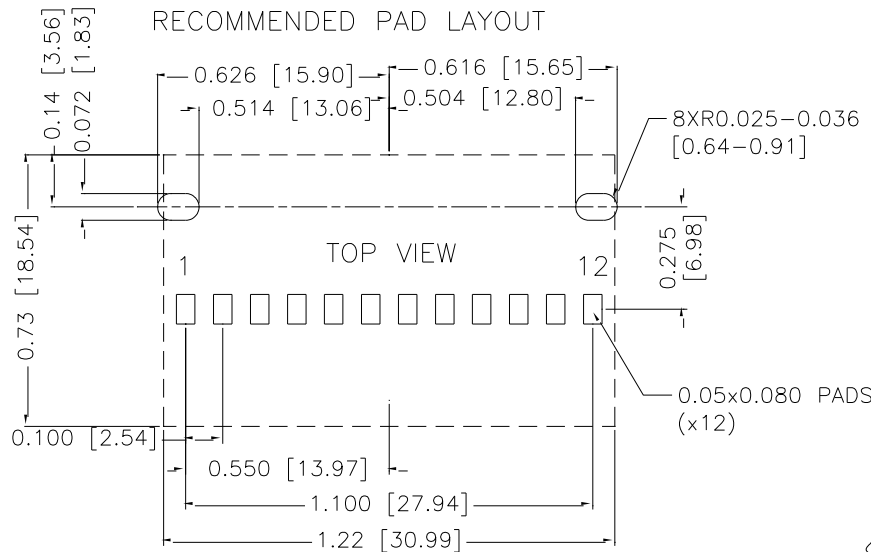
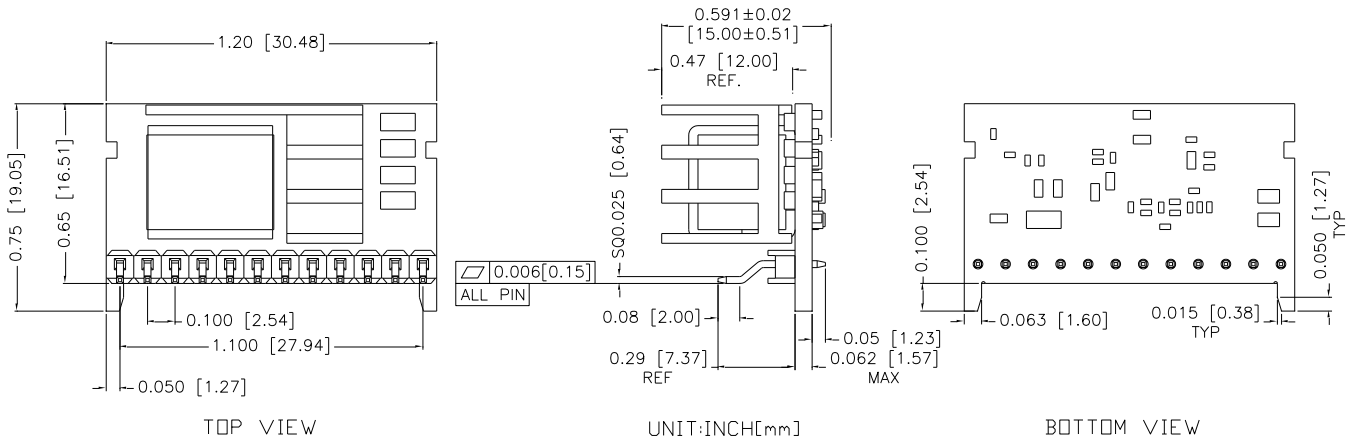

PIN CONNECTIONS

PIN	FUNCTION	PIN	FUNCTION
1	Vout	7	Trim
2	Vout	8	PGOOD
3	Vout	9	Vsense+
4	GND	10	Vsense-
5	GND	11	GND
6	Enable	12	Vin

NOTE: 1) All Pins: Material - Copper Alloy;
 Finish - 3 micro inches minimum Gold over 50 micro inches minimum Nickel plate
 2) Undimensioned components are shown for visual reference only.
 3) All dimensions in inches (mm); Tolerances: x.xx +/-0.02 in. (x.x +/-0.5mm) x.xxx +/-0.010 in. (x.xx +/-0.25mm)

22. REVISION HISTORY

DATE	REVISION	CHANGES DETAIL	APPROVAL
2013-08-19	PA	First release	J Yan
2013-10-10	PB	Update mechanical drawing	J Yan
2014-01-10	PC	Update input / output spec, efficiency and remote on/off.	J Yan
2014-4-14	PD	Update Output Specs, General, Efficiency Data, NR, TR, Startup & Shutdown, OCP	J Yan
2014-7-3	PE	Update part number explanation, RoHS compliance , Add MD Note.	J Yan
2014-7-11	PF	Update Cover, MD	J Yan
2014-7-29	G	Added assembly guide drawing	J Yan
2014-12-18	H	Added trim resistor equation	J Yan
		Input specs :	
		1. Change no load input current.	
		2. Change remoted off input current to 15mA.	
		3. Change input reflected ripple current (RMS) from 20mA to 30mA.	
		4. Update turn on voltage threshold: min value 3.8V, typical value 4.3V, max value 5V.	
		5. Update turn off voltage threshold: min value 3.8V, typical value 4.1V, max value 4.5V.	
		Output specs:	
2015-07-07	I	1. Change output voltage set point max to 10%Vo. 2. Change the load/line regulation range as $\pm 5\%V_o$. 3. Change output ripple and noise max value to 30mV. 4. Update transient response.	J Yan
		General:	
		1. Update the efficiency. Including efficiency data and graphs.	
		2. Update the weight of module.	
		Update the TD	
		Add the input noise. Add the PG signal section.	
		Update mechanical drawing, change the thickness of module to 0.591 inch, change the thickness of heatsink to 0.47 inch.	
2015-11-16	J	Output specs: Shrink the output voltage set point, line regulation, load regulation rang. Update the waveform of ripple and noise/transient response/Startup%Shutdown; add tilt dimension in mechanical drawing, update recommended pad layout.	J Yan
2016-01-05	K	Output specs; Shrink the output voltage set point, line regulation, load regulation range.	J Yan
2016-01-22	L	Update MTBF FIT	J Yan
2016-02-02	M	Input specs: Update the turn on voltage informaiton	J Yan
2016-05-17	N	Input specs: Update the turn on voltage information	J Yan

For more information on these products consult: tech.support@psbel.com

NUCLEAR AND MEDICAL APPLICATIONS - Products are not designed or intended for use as critical components in life support systems, equipment used in hazardous environments, or nuclear control systems.

TECHNICAL REVISIONS - The appearance of products, including safety agency certifications pictured on labels, may change depending on the date manufactured. Specifications are subject to change without notice.